

**System and Procedure
For
Compliance to Revised Emission Standards (dated 03.11.2022)
for
Power Generating Set Engines
(Up-to Gross Mechanical Power 800 KWs)**

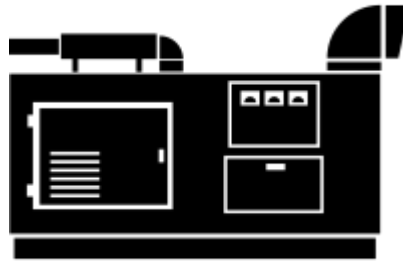

28/03/2023



CENTRAL POLLUTION CONTROL BOARD

(Ministry of Environment, Forest and Climate Change)

Parivesh Bhawan, East Arjun Nagar

Delhi - 110032

PREFACE

Ministry of Environment, Forest and Climate Change (MoEF & CC) in consultation with Central Pollution Control Board (CPCB) has notified revised emission standards for internal Combustion engines used for power generating sets vide GSR 804(E.) dated 3-Nov-2022. As per notification, CPCB is the 'Nodal Agency' and mandated to prepare 'System and Procedure' to ensure compliance, settle disputes and resolve technical difficulties in execution of these rules. In consonance with changes in emission standards, additional requirements such as NO_x and particulate matter control diagnostics and anti-tampering measures (inducement) are also required to be considered.

This document has accordingly been prepared to comprehensively cover compliance requirements. It is divided into four main parts titled as A1, A2, A3 & A4 for ease of handling & reference. Part A1 is related to Compression Ignition (CI) base engines, part A2 pertains to Positive Ignition (PI) base engines, part A3 is associated to Portable Genset (PG) engines and part A4 is linked to safety code of practice.

Further, each of the main parts of the document (except part A4) is further divided in four parts. Part-I is regarding notifications including its amendments as issued from time to time by MoEF&CC. Part-II is related to Certification Systems and Procedures. This part is an administrative part to regulate emission standards of new gensets at manufacturing stage. On compliance of notified standards, Type Approval (TA) Certificate is issued by Certification Agency (as specified in notification as presented in Part - I of this document) to the industry for its complied family / model Genset engine(s). After obtaining TA, the industries are required to obtain Conformity of Production (COP) Certificate every COP year (1st July to 30th June of the subsequent year). Part-III of the document is the description of equipments and test procedures to be adopted in compliance testing process. This part is to be executed by the Certification Agencies. Finally, Part-IV of the document consists of newly added NO_x & particulate control measures & others requirements.

The document has been prepared by CPCB in due consultation and involvement of certification agencies (ARAI and ICAT), Indian Diesel Engine Manufacturer's Association (IDEMA) and National Level Standing Committee on Emissions (SCOE).

I hope that the document would be of immense help to all the manufacturers of genset engines and certification agencies in obtaining / issuing TA and COP certificates in a systematic and scientific manner. Academician and other stake-holders shall also be benefited.

[Prashant Gargava]
Member Secretary, CPCB

CONTRIBUTION

Planning, Coordination & Report Preparation : Mr. N.K. Gupta , Scientist 'E' & Head UPC-I
Dr. C.K.Dixit, Scientist 'C'

Technical input provided by : ARAI, ICAT and IDEMA

Recommended by : "Standing Committee on Emission from off-road
Vehicles & Construction Equipments"

Technically Recommended by : Dr. Prashant Gargava , Member Secretary, CPCB

:

:

:

INTRODUCTION

Ministry of Environment, Forest and Climate Change (MoEF & CC) in consultation with Central Pollution Control Board (CPCB) has notified revised emission standards for internal Combustion engines used for power generating sets vide GSR 804(E.) dated 3-Nov-2022. These norms are referred to as Environmental Protection (Third Amendment) Rules. Said emission norm can be also referred to as 'CPCB IV+ emission regulation. To prescribe test methods for the above norms, a task was entrusted to a committee headed by ARAI for preparation of 'System and Procedure'. This 'System and Procedure' prescribes Test Methods, Testing Equipments and related Procedures for Type Approval and Conformity of Production (CoP) testing, NO_x & Particulate control measures of Gensets up to 800 kW Mechanical Power.

While preparing 'System and Procedure', considerable assistance has been taken from following regulations/documents:

- i. UN Regulation 96 (05 series of amendments Date of Entry into Force: 29.12.18): Uniform provisions concerning the approval of engines to be installed in Agricultural and Forestry Tractors and in Non-Road Mobile Machinery with regard to the emissions of pollutants by the engine.
- ii. Commission Delegated Regulation (EU) 2017/655 of 19 December 2016 supplementing Regulation (EU) 2016/1628 of the European Parliament and of the Council with regard to monitoring of gaseous pollutant emissions from in-service internal combustion engines installed in Non-Road Mobile Machinery
- iii. AIS-137 (Part 7) August 2019 -Test Method, Testing Equipment and Related Procedures for Type Approval and Conformity of Production (CoP) testing of Agricultural Tractors, Construction Equipment Vehicles (CEVs) & Combine Harvesters for Emission Norms as per CMV Rules 115 and 126
- iv. UN Regulation 120: Uniform provisions concerning the approval of internal combustion engines to be installed in Agricultural and Forestry Tractors and in Non-Road Mobile Machinery, with regard to the measurement of the net power, net torque and specific fuel consumption
- v. ISO 8178- Part 1, ISO 8178-Part 3, ISO 8178-Part 4, ISO 8178-Part 7, ISO 8178-Part 9
- vi. US EPA Regulation: 40 CFR Part 1039 - Control of emissions from new and in-use non-road compression-ignition engines
- vii. US EPA Regulation: 40 CFR Part 1065 - Engine testing procedures
- viii. AUTOMOTIVE INDUSTRY STANDARD - AIS 024 - Safety and procedural requirements for type approval of gaseous fuelled vehicles
- ix. AUTOMOTIVE INDUSTRY STANDARD - AIS 028 - Code of practice for use of gaseous fuels in internal combustion engine vehicles
- x. Central Motor Vehicle Rules, 1989: CMV Rule 115 - as amended time to time

The Committee Composition for formulation of this 'System and Procedure' is given in Annex 11. After recommendation of the 'System and Procedure' by SCOE, Central Pollution Control Board being a Nodal Agency has published this document.

OVERALL SCOPE

This document lays down the applicability and requirements; system & procedure for compliance to the rules vide notification no. GSR 804(E.) dated 3-Nov-2022. Emission limits for new internal combustion engine up to 800 kW gross mechanical power for generator set (Genset) application, issued by Ministry of Environment and Forests, Government of India. The details are covered as under:

Emission of gaseous and particulate pollutants from following distinct internal combustion engines categories and fuel options operating with either constant speed duty cycle or variable speed duty cycle,

- a) Diesel engines
- b) Dedicated alternate fuels*
- c) Bi-fuel run either on Gasoline or on any one of the alternate fuels*
- d) Dual Fuel# run on Diesel and any of the alternate fuels*
- e) Portable Generator sets (PI engines below 19kW and up to 800 cc displacement) run on Gasoline fuel, dedicated alternate fuels and Bi-fuel run either on Gasoline or on any one of the alternate fuels*

#Dual fuel – Diesel and Natural Gas/Bio methane/LPG applicable only

*Alternate fuels - Natural Gas/Bio methane, LPG, Ethanol blended gasoline (E10, E12, E15, E20, E85) Ethanol E100, ethanol blended diesel (ED95), Methanol blended gasoline (M15, M85), Methanol M100, methanol blended diesel (MD95), DME, Hydrogen, Hydrogen blended with CNG (18% hydrogen), Bio-diesel (B7/ B8 to B20/B100) (Fuel Specification of these fuels shall be as notified under CMVR as amended from time to time)

Natural Gas can be used in the form of Compressed Natural Gas or Liquefied Natural Gas or Piped Natural Gas.

This document is divided into four main Part A1, A2, A3 & A4 for easy of handling & to refer for the industry and test agency as per the following

Part A1: Applicable for all Compression Ignition Engines

- Diesel engines
- Dual Fuel run on Diesel + any of the alternate fuels*

Part A2: Applicable for Positive Ignition Engines (above 800 cc displacement)

- Dedicated alternate fuels*
- Bi-fuel run either on Gasoline or on any one of the alternate fuels*

Part A3: Applicable for Portable Generator sets (PI engines below 19kW and up to 800 cc displacement)

- Gasoline fuel
- Dedicated alternate fuels
- Bi-fuel run either on Gasoline or on any one of the alternate fuels*

Part A4: Safety code of practice

The details are covered in each above part (except A4) are as under;

- I. Exhaust emission limits, applicability & other requirement
- II. Certification system and procedure
- III. Test equipment & Test procedure
- IV. NOx and PM control measures and other requirement

Part - A1

Applicable for Compression Ignition (CI) Engines

CONTENTS

Clause & Annexures	Description	Page
1.	Scope	15
2.	Definitions and abbreviations	16
3.	Exhaust emission limits & applicability and requirement	22
4.	Type approval Administrative procedure	26
4.1	Engine type & engine family (<i>ISO 8178-7</i>)	26
4.2	Selection of certification agency	27
4.3	Application for type approval (TA)	28
4.4	Type approval	29
4.5	Certificate of type approval and validity	29
4.6	Modifications and extension of approval of the approved type	30
4.7	Type approval process flow chart	32
Appendix 1	Application to Nodal Agency. Affidavit & profile details	34
5.	Conformity of Production (CoP) Administrative procedure	37
5.1	General	37
5.2	Verification of conformity of production (CoP)	37
5.3	Sample size, decision, and other criteria for verification of CoP	38
5.4	Certificate of Conformity of Production & validity	42
5.5	CoP discontinuity	42
5.6	Exemption from CoP	43
5.7	Production definitively discontinued	43
5.8	Consequences of Non-conformity of production	44
5.9	CoP process flow chart	45
Annexure 1	Information document from manufacturer	49
Appendix A.1	Template for information folder and information document	49
Appendix A.2	Confidential information on emission control strategy	53
Appendix A.3	Template for submission of engine technical specification	54
Annexure 2	Communication – Type Approval and COP Template to be attached here by Test Agencies	67
Appendix A.1	Test report	71
Annexure 3	Labelling requirement	75
Annexure 4	Test equipment, test bed measurement system and test facility (<i>ISO 8178-1, NABL accredited</i>)	76
Annexure 5	Method of data evaluation and test result calculation (<i>ISO 8178-4</i>)	77

Annexure 6	Technical characteristics of fuels prescribed for approval test and to verify conformity of production	78
Appendix 1	Reference diesel fuel characteristics	78
Appendix 2	Commercial diesel fuel characteristics	80
Appendix 3	Other liquid fuels: Ethanol (ED95) ¹	81
Appendix 4	Gaseous fuel for dual fuel engine: i) LPG ii) Natural Gas/Bio-methane	83
Annexure 7	Requirements, Tests & Test procedure	87
Appendix 1	Emission test cycle introduction. Characteristics of steady state test cycles (ISO 8178-4)	89
Appendix 2	Off cycle emission over control area (ISO 8178-4)	94
Appendix 3	Method of measuring smoke (ISO 8178-3, ISO 8178-9)	99
Appendix 4	Gross power measurement procedure	100
Appendix 5	Crankcase ventilation requirement (ISO 8178-4)	103
Appendix 6	Emission durability periods (EDP), deterioration factor and methodology for adapting the emission laboratory test results to include the deterioration factor	104
Appendix 7	Procedures for measurement and calculation of ammonia (ISO 8178-1, ISO 8178-4)	111
Appendix 8	Method of test execution and measurement procedures. Procedure for developing the infrequent regeneration adjustment factor (IRAFs) for engine with exhaust after-treatment system (ISO 8178-4)	111
Appendix 9	Additional requirement for variable speed engine for demonstration/determination/ verification of declared speed values for emission test cycle	112
Annexure 8	Requirements with regard to emission control strategies, NO_x control measures and Particulate control measures	116
Appendix A.1	Additional technical requirements on NO _x control measure including the method to demonstrate these strategies	120
Appendix A.2	Technical requirements on particulate pollutant control measures, including the method to demonstrate these measures	142
Appendix A.3	Technical details for prevention of tampering	149
Appendix A.4	Technical details for remote information and monitoring requirements	150
Annexure 9	Installation in the GENSET Application	151
Appendix 1	Details of the relevant information and instructions for the GOEM	152
Appendix 2	Details of the relevant information and instructions for the end-users	154
Annexure 10	Technical requirements for dual-fuel engines	156
Appendix A.1	Dual-fuel engine dual-fuel indicator, warning system operability restriction – Demonstration requirements	162
Appendix A.2	Emission test procedure requirements for dual-fuel engines	163
Appendix A.3	Types of dual-fuel engines operated on natural gas/biomethane or LPG and a liquid fuel – illustration of the definitions and main requirements	168
Appendix A.4	Safety checks for use of gaseous fuelled (dual fuel / dedicated dual fuel as applicable) internal combustion engine	169
Appendix A.5	Labelling Requirement for dual fuel engines	172
Annexure 11	Composition of Committee	173
Annexure 12	CPCB IV Plus Notification GSR copy as released	174

Part – A2

Applicable for Positive Ignition (PI) Engines

CONTENTS

Clause & Annexures	Description	Page
1.	Scope	182
2.	Definitions and abbreviations	183
3.	Exhaust Emission Limits, applicability and Requirement	188
4.	Type Approval Administrative procedure	191
Appendix 1	Application to Nodal Agency. Specimen of submission for Affidavit & profile details of Manufacturer	198
5.	Conformity of Production (CoP) Administrative procedure	201
Annexure 1	Information document from manufacturer	213
Appendix A.1	Template for information folder and information document	213
Appendix A.2	Confidential information on emission control strategy	216
Appendix A.3	Template for submission of engine technical specification	217
Annexure 2	Communication – Type Approval and COP Template to be attached here by Test Agencies	229
Appendix A.1	Test report	233
Annexure 3	Labelling requirements	237
Annexure 4	Test equipment, test bed measurement system and test facility (ISO 8178-1, NABL accredited)	238
Annexure 5	Data evaluation, test result calculation of gaseous & emission, test execution and measurement procedures (ISO 8178-4)	239
Annexure 6	Technical characteristics of fuels prescribed for approval test and to verify conformity of production	240
Appendix 1	Reserved	240
Appendix 2	Reserved	240
Appendix 3	Reserved	240
Appendix 4	Alternate Fuel Specification	240
Annexure 7	Requirements, Tests & Test procedure	244
Appendix 1	Emission test cycle Introduction and Characteristics of steady state test cycles (ISO 8178-4)	246
Appendix 2	Reserved	247
Appendix 3	Reserved	247
Appendix 4	Gross power measurement procedure	248
Appendix 5	Crankcase ventilation requirement (ISO 8178-4)	250
Appendix 6	Emission Durability Period (EDP), Deterioration Factor and Methodology for Adapting Emission Lab Test Results.	251

Appendix 7	Procedure for the Measurement & Calculation of Ammonia Emissions (ISO 8178-1, ISO 8178-4)	258
Appendix 8	Reserved	258
Appendix 9	Reserved	258
Annexure 8	Requirements regarding emission control strategies, NOX control measures	259
Appendix A.1	Additional technical requirements on NOX control measure including the method to demonstrate these strategies	263
Appendix A.2	Reserved	284
Appendix A.3	Technical details for prevention of tampering	284
Appendix A.4	Technical details for remote information and monitoring requirements	285
Annexure 9	Installation in the Genset Application	286
Appendix 1	Details of the relevant information and instructions for the GOEM	287
Appendix 2	Details of the relevant information and instructions for the end-users	289
Annexure 10	Alternate Fuel System Safety Standard	291

Part – A3

Portable Generator sets

CONTENTS

Clause & Annexures	Description	Page
1.	Scope	296
2.	Definitions and abbreviations	297
3.	Exhaust emission limits & applicability	301
4.	Type Approval Administrative procedure	303
4.1	Genset type & genset family	303
4.2	Selection of certification agency	303
4.3	Application for type approval (TA)	304
4.4	Type approval	305
4.5	Certificate of type approval and validity	305
4.6	Modifications and extension of approval of the approved type	306
4.7	Type approval process flow chart	308
Appendix -1	Application to Nodal Agency. Affidavit & profile details	310
5.	Conformity of Production (CoP) Administrative procedure	313
5.1	General	313
5.2	Verification of conformity of production (CoP)	313
5.3	Sample size, decision, and other criteria for verification of CoP	313
5.4	Certificate of Conformity of Production & validity	316
5.5	CoP discontinuity	316
5.6	Exemption from CoP	317
5.7	Production definitively discontinued	317
5.8	Consequences of Non-conformity of production	317
5.9	CoP process flow chart	319
Annexure - 1	Information document- Template for submission of genset technical specification	323
Annexure - 2	Specimen copy for Type Approval and CoP certificate	330
Annexure - 3	Labelling requirement	333
Annexure - 4	Test equipment, test fuel, test procedure & test result calculation	334
Annexure - 5	Additional requirement for emission control strategy	341
Annexure - 6	Technical characteristics of fuels prescribed for approval test and to verify conformity of production	342
Annexure - 7	Compliance to safety code of practice for alternate fuel generator sets	349
Annexure - 8	Additional requirement for variable speed portable generator sets	350

Part – A4

Safety Code of Practice Applicable for engines other than Gasoline and Diesel

CONTENTS

Clause & Annexures	Description	Page
1.	Scope	352
2.	References	353
3.	Definitions	354
4.	Abbreviations	356
5.	Safety requirements	357
5.1	General Design Requirements	357
5.2	Cylinder for CNG/LPG or PNG	358
5.3	Fittings on CNG cylinders & its Cascades and filling connection	358
5.4	Location, Ventilation and Mounting of NG/LPG Cylinders	359
5.5	Cylinder(s) installation	360
5.6	Shielding	365
5.7	Construction of compartments and sub-compartments	366
5.8	NG/CNG/LPG Fuel Line	367
5.9	CNG/PNG/LPG Control Equipment	369
5.10	Compliance plate	373
5.11	Labels	374
6.	Instructions to be provided by the GENSET Manufacturer	376
7.	Inspection, testing and commissioning by GENSET manufacturer or authorized person appointed by GENSET manufacturer	377
7.1	Commissioning	377
7.2	Initial inspection and installation certificate	377
7.3	Periodic Inspection /preventive maintenance	377
7.4	Leak Test	377
7.5	Repair of NG/LPG System	378
7.6	Scrapping of Cylinder	379
8.	Statutory authority approval	380
9.	Type approval administrative procedure	381
9.1	Selection of Certifying Agency	381
9.2	Application of type approval	381
9.3	Type Approval	382

9.4	Certificate of Type Approval and Validity	382
9.5	Modification and Extensions of approved type	383
9.6	Type Approval Process	383
Appendix A.1	Template for submission of engine technical specification	385
Annexure- 1	Freezing conditions and corrosive conditions	403
Annexure- 2	Backfire – deflector tests	404
Annexure- 3	Checklist for installation for NG/LPG GENSET	406
Annexure- 4	Installation certificate for converted CNG/PNG/ LPG GENSET engine manufacturer/ authorized person of GENSET manufacturer	408
Annexure- 5	Component testing and safety checks for use of NG/CNG fuels in internal combustion engine for generator	410
Annexure- 6	Safety checks for use of LPG fuels in internal combustion engine for generator	412
Annexure- 7	Roles & responsibility of various stakeholders	414
Annexure- 8	Labelling requirements	415
Appendix-8.1	Label	416

This page intentionally kept blank

Part – A1

Compression Ignition (CI) Engines

1. SCOPE

This **A1** document lays down the applicability and requirements, system & procedure for compliance to the rules vide notification no. GSR 804(E.) dated 3-Nov-2022 on emission limits for new internal combustion engine up to 800 kW gross power used for power generating set (Genset) application, issued by Ministry of Environment, Forests & Climate change, Government of India.

Emission of gaseous CO, HC, NO_x and Particulate pollutants and Smoke from following type of compression ignition internal combustion engines operating with either constant speed duty cycle or variable speed duty cycle,

- Diesel engines
- Dual Fuel engine run on Diesel fuel + any of the alternate fuels*

*Alternate fuels - Natural Gas/Biomethane, LPG (Fuel Specification of these fuels shall be as notified under CMVR as amended from time to time)

Natural Gas can be used in the form of Compressed Natural Gas or Liquefied Natural Gas or Piped Natural Gas.

Following parts of specified standards shall be referred wherever stated.

Sr No.	Standard	Title
1	ISO 8178-1: 2017 ISO 8178-1: 2020	Reciprocating internal combustion engines — Exhaust emission measurement — Part 1: Test-bed measurement systems of gaseous and particulate emission
2	ISO 8178-3: 2019	Exhaust emission measurement — Part 3: Test procedure for measurement of exhaust gas smoke emissions from compression ignition engines using a filter type smoke meter
3	ISO 8178-4: 2017 ISO 8178-4: 2020	Reciprocating internal combustion engines — Exhaust emission measurement — Part 4: Steady-state and transient test cycles for different engine application
4	ISO 8178-7: 2015	Reciprocating internal combustion engine-Exhaust emission measurement-Part-7: Engine family determination
5	ISO 8178-9: 2019	Reciprocating internal combustion engines — Exhaust emission measurement — Part 9: Test cycles and test procedures for measurement of exhaust gas smoke emissions from compression ignition engines using an opacimeter
6	40 CFR Part 1039	US EPA Regulation: 40 CFR Part 1039 - Control of emissions from new and in-use nonroad compression-ignition engines
7	40 CFR Part 1065	US EPA Regulation: 40 CFR Part 1065 – Engine testing procedures
8	AIS 024 (Version 5)	Safety and Procedural requirements for type approval of CNG/Bio-CNG/LNG operated vehicles (dedicated, bi-fuel & dual fuel)
9	AIS 028 (Version 5)	Code of practice for use of CNG/Bio-CNG/LNG fuel in internal combustion engines

2. DEFINITION & ABBREVIATIONS

2.1 DEFINITIONS

1. **“Approval of an engine (engine family)”** means the approval of an engine type with regards to the level of the emission of gaseous, particulate and smoke pollutants;
2. **“Auxiliary emission control strategy”** means any element of design that senses temperature, engine RPM, or any other parameter for the purpose of activating, modulating, delaying, or deactivating the operation of any part of the emission control system;
3. **“Adjustment factors”** mean additive (upward adjustment factor and downward adjustment factor) or multiplicative factors to be considered during the periodic (infrequent) regeneration;
4. **“Ageing cycle”** means the machine or engine operation (speed, load, power) to be executed during the service accumulation period
5. **“Applicable emission limit”** means an emission limit to which an engine is subject to for approval;
6. **“Approval of an engine”** means the approval of an engine type or family with regard to the level of emission of gaseous and particulate pollutants by the engine;
7. **“Base emission control strategy”** means design strategy that is active throughout the speed and load operating range of engine unless Auxiliary emission control is activated;
8. **“Compressed natural gas (CNG / BIO CNG)”** means a compressed gaseous fuel composed predominantly of Methane (CH₄) shall be used as specified by the Government of India from time to time.
9. **“Confirmed and active DTC”** means a DTC that is stored during the time the NCD system concludes that a malfunction exists;
10. **“Constant speed engine”** means an engine whose type approval or certification is limited to constant-speed operation. Engines whose constant-speed governor function is removed or disabled are no longer constant-speed engines;
11. **“Constant speed operation”** means engine operation with a governor that automatically controls the operator’s demand to maintain engine speed, even under changing load. Governors do not always maintain exactly constant speed, but shall be maintained with allowed tolerances as mentioned in the document”
12. **“Continuous regeneration”** means the regeneration process of an exhaust after-treatment system that occurs either in a sustained manner or at least once over the applicable emission test cycle; in contrast to periodic (infrequent) regeneration;
13. **“Critical emission related components”** means the components which are designed primarily for emission control, that is, any exhaust after-treatment system, the electronic engine control unit and its associated sensors and actuators, fuel injection equipment, turbocharger and its integral control actuators and the EGR system including all related filters, coolers, control valves and tubing;
14. **“Critical emission related maintenance”** means the maintenance to be performed on critical emission-related components;
15. **“De-NO_x system”** means an exhaust after-treatment system designed to reduce emissions of oxides of nitrogen (NO_x) (e.g. passive and active lean NO_x catalysts, NO_x absorbers and selective catalytic reduction (SCR) systems);
16. **“Dedicated Dual fuel engine”** Dedicated Dual fuel engine operation shall mean a two – fuel system having diesel as a primary combustion fuel and CNG or Bio CNG or LPG as supplementary fuel and such

dedicated dual fuel engine shall not operate on diesel stand-alone mode in absence of gaseous fuel and in such dedicated dual fuel engine, mass emission test will be carried out in dual fuel mode only.”

17. **“Diagnostic trouble code – DTC”** means a numeric or alphanumeric identifier which identifies or labels a NO_x Control Malfunction or a Particulate Control Malfunction.
18. **“Dual fuel engine”** shall mean a two – fuel system having diesel as a primary combustion fuel and CNG or Bio CNG or LPG as supplementary fuel. Such dual fuel engine may operate on diesel stand-alone mode in absence of gaseous fuel.
19. **“Discrete mode”** means relating to a discrete mode type of steady-state test, as described in ISO 8178-4.
20. **“Emissions-related defect”** means a deviation from normal production tolerances in design, materials, system or assembly that affects any parameter, specification or component belonging to the emission control system. A missing component may be considered to be an emission-related defect;
21. **“Emission control system”** means the exhaust after treatment system including reagent and HC dosing system, the electronic management controllers of the engine system (if utilized) and any emission related component of the engine system in the exhaust which supplies an input to or receives an output from these controllers and when applicable the communication interface between the engine system electronic control unit (ECU) and any other power train with respect to emissions management;
22. **“Engine system”** means the engine, the emission control system and the communication interface (hardware and messages) between the engine system electronic control unit (ECU) and any other power train;
23. **“Engine family”** means a manufacturer’s grouping of engine systems which, through their design have similar exhaust emission characteristics, all members of the family must comply with the applicable emission limit values described in Clause 3.1. Also refer ISO 8178-7;
24. **“Engine type”** means a category of engines, which do not differ in such essential respects as engine characteristics as defined in ISO 8178-7
25. **“Exhaust after treatment system”** means ‘a catalyst (oxidation or 3-way), a particulate filter, a de-NO_x system, a combined de-NO_x particulate filter’ or any other emission-reducing device that is installed downstream of the engine. This definition excludes exhaust gas recirculation, which, where fitted is considered an integral part of the engine system;
26. **“Engine governed speed”** means the engine operating speed when it is controlled by the installed governor;
27. **“Electronically controlled engines”** means the engines using electronic control to determine both the quantity and timing of injecting fuel.
28. **“Electronic control unit (ECU)”** means an engine’s electronic device that uses data from engine sensors to control engine parameters as primary function. ECU may contain more functionality than stated above of interest;
29. **“Emission control strategy”** means a combination of an emission control system with one base emission control strategy and with one set of auxiliary emission control strategies, incorporated into the overall design of an engine or Genset into which the engine is installed;
30. **“Emission durability period”** mean the number of hours indicated in Appendix 6 of Annexure 7 used to determine the deterioration factors
31. **“Emission related maintenance”** means maintenance which substantially affects emissions, or which is likely to affect emissions performance deterioration of the vehicle or the engine and exhaust after treatment system during normal in-use operation;

32. **“Engine-after treatment system family”** means a manufacturer’s grouping of engines that complies with the definition of engine family, but which are further grouped into a family of engine families utilising a similar exhaust after-treatment system;
33. **“Exhaust gas recirculation”** means a technology that reduces emissions by routing exhaust gases that have been exhausted from the combustion chamber(s) back into the engine to be mixed with incoming air before or during combustion. The use of valve timing to increase the amount of residual exhaust gas in the combustion chamber(s) that is mixed with incoming air before or during combustion (also called ‘internal EGR’) is not considered exhaust-gas recirculation for the purposes of this Regulation;
34. **For Domestic products**, Date of Manufacture means the date on which the engine or genset is invoiced;
35. **For Imported products**, Date of Import means the date of payment of custom duties applicable to the engine or Genset;
36. **“Genset Engine”** means engines used primarily to operate an electrical generator / alternator to produce and supply electric power for other applications in lieu of supply of power from electric grid;
37. **“Gas Energy Ratio (GER)”** means in case of a dual-fuel engine the ratio (expressed as a percentage) of the energy content of the gaseous fuel over the energy content of both fuels (diesel and gaseous).
38. **“Gaseous pollutant”** means carbon monoxide (CO), hydrocarbons (HC – assuming a ratio of C₁H_{1.85}) and oxides of nitrogen (NO_x), the last named being expressed in nitrogen dioxide (NO₂) equivalent;
39. **“High idle speed”** means ‘the speed achieved by the engine under the specified test conditions at full throttle with no external load applied on the engine flywheel
40. **“Hydrocarbon (HC)”** means Total Hydrocarbon (THC), non-methane hydrocarbon (NMHC) as applicable. Hydrocarbon generally means the hydrocarbon group on which the emission standards are based for each type of fuel and engine
41. **Internal combustion engine (ICE)”** means an engine, which works on the either compression-ignition principle or positive ignition principle utilising liquid, gaseous or combination of both fuels;
42. **“Idle speed”** means the lowest engine speed with minimum load (greater than or equal to zero load), where an engine governor function controls engine speed. For engines without a governor function that controls idle speed, idle speed means the manufacturer-declared value for lowest engine speed possible with minimum load. Note that warm idle speed is the idle speed of a warmed-up engine.
43. **“Liquefied Natural Gas (LNG)”** means a Natural gas that has been cooled to -259 degrees Fahrenheit (-161 degrees Celsius) and at which point it is condensed into a liquid which is colourless, odourless, non-corrosive and non-toxic. Characterized as a cryogenic liquid. Fuel quality for GENSET use shall meet the requirements of BIS specification as notified from time to time by MoPNG, Govt. of India.
44. **“Manufacturer”** means engine or Genset manufacturer, importer or, assembler (as noted in notification);
45. **“NCD engine family”** means a manufacturer’s grouping of engine systems having common methods of monitoring/diagnosing NCMs;
46. **“NO_x control diagnostic system (NCD)”** means system on-board the engine which has the capability” of: Detecting a NO_x control malfunction; Identifying the likely cause of Nox control malfunctions by means of information stored in computer memory and/or communicating that information off-board;
47. **“NO_x control malfunction (NCM)”** means an attempt to tamper with the Nox control system of an engine and/or exhaust after treatment system or a malfunction affecting that system that might be due to tampering, that is considered by this Regulation as requiring the activation of a warning or an inducement system once detected;
48. **“Non-emission related maintenance”** means maintenance which does not substantially affect emissions, and which does not have a lasting effect on the emissions performance deterioration of the machine or the engine during normal in-use operation once the maintenance is performed;

49. **“Non-methane hydrocarbons (NMHC)”** means the sum of all hydrocarbon species except methane;
50. **“Oxides of Nitrogen (NO_x)”** means compounds containing only nitrogen and oxygen as measured by the procedures specified in this Regulation. Oxides of nitrogen are expressed quantitatively as if the NO is in the form of NO₂, such that an effective molar mass is used for all oxides of nitrogen equivalent to that of NO₂.
51. **“Opacity meter”** means an instrument used to measure the opacity of smoke particles by means of the light absorption principle;
52. **“Open crankcase emissions”** means any flow from an engine’s crankcase that is emitted directly into the environment;
53. **“Operator demand”** means an engine operator’s input to control engine output. The “operator” may be a person (i.e. manual), or a governor (i.e., automatic) that mechanically or electronically signals an input that demands engine output. Input may be from an accelerator pedal or signal, a throttle-control lever or signal, a fuel lever or signal, a speed lever or signal, or a governor set-point or signal
54. **“Particulate matter (PM)”** means any material collected on a specified filter medium after diluting C.I. engine exhaust gas with clean filtered air so that the temperature is within 47 +/- 5 °C;
55. **“Percent load”** means the fraction of declared rated torque at an engine speed;
56. **“Periodic or infrequent regeneration”** means the regeneration process of an exhaust after-treatment system that occurs periodically in typically less than 100 hours of normal engine operation. During cycles where regeneration occurs, emission limits may be exceeded;
57. **“Placing on the market”** means the action of making available a product covered by this Regulation on the market of a country applying this Regulation, for payment or free of charge, with a view to distribution and/or use in the country
58. **“Parent engine”** means an engine selected from an engine family in such a way that its emissions characteristics will be representative for that engine family and that it complies with the requirements set out in ISO 8178-7
59. **“Power generating set or Genset”** means any equipment which is used for electric power generation in absence or failure of grid power utilizing engine system defined in this document as prime mover;
60. **“Particulate after treatment device”** means an exhaust after treatment system designed to reduce emissions of particulate pollutants through a mechanical, aerodynamic, diffusion or inertial separation;
61. **“Rated power”** means nominal power in kW declared by manufacturer at declared rated Speed
62. **“Rated speed”** is the engine speed at which the declared rated power occurs with allowed tolerances as mentioned in the document"
63. **“Ramped modal steady-state test cycle”** means a test cycle with a sequence of steady state engine test modes with defined speed and torque criteria at each mode and defined speed and torque ramps between these modes
64. **“Reagent”** means any consumable or non-recoverable medium required and used for the effective operation of the exhaust after-treatment system;
65. **“Regeneration”** means an event during which emissions levels change while the after-treatment performance is being restored by design. Two types of regeneration can occur: continuous regeneration and infrequent (periodic) regeneration;
66. **“Service Mode”** For dedicated dual fuel engines (Type 1A & 2A), in absence of gaseous fuel or operation of the engine in diesel mode only shall be restricted by reduced power output to 40 percent and in such

dedicated dual fuel engine, mass emission test will be carried out in dual fuel mode only.”

67. **“Smoke”** means particles suspended in the exhaust stream of a diesel engine which absorb, reflect, or refract light. Also refer ISO 8178-3 and ISO 8178-9;
68. **“Scan tool”** means an external test equipment used for off-board communication with NCD & PCD system;
69. **“Service accumulation schedule”** means the aging cycle and the service accumulation period for determining the deterioration factors for the engine-after treatment system family;
70. **“Total hydrocarbon (THC)”** means the combined mass of organic compounds measured by the specified procedure for measuring total hydrocarbon, expressed as a hydrocarbon with a hydrogen-to-carbon mass ratio of 1.85:1;
71. **“Test Cycle”** means a sequence of test points each with a defined speed and torque to be followed by the engine during standardised emission assessment test. Also refer ISO 8178-4;
72. **“Type approval”** means the approval of an engine type with regard to its emissions measured in accordance with the procedures specified in this Regulation;

2.2 Abbreviations

BSFC	Brake-specific fuel consumption
BIS	Bureau of Indian Standards
CPCB	Central Pollution Control Board
C ₁	Carbon 1 equivalent hydrocarbon
CC	Cubic Centimetre
CH ₄	Methane
C ₂ H ₆	Ethane
C ₃ H ₈	Propane
CNG	Compressed Natural Gas
CO	Carbon monoxide
CO ₂	Carbon dioxide
COP	Conformity of Production
COP-Year	Period starting 1 st July of year till 30 th June of subsequent year
CI	Compression-ignition (Engine)
De-NO _x	NO _x after-treatment system
DF	Deterioration factor
ECM	Electronic control module
EGR	Exhaust gas recirculation
FBC	Fuel borne catalyst (for soot regeneration)
FID	Flame Ionization Detector
GOEM	Genset Original Equipment Manufacturer
HC	Hydrocarbon
H ₂ O	Water
ISO	International Organization for Standardization
LPG	Liquefied Petroleum Gas
LNG	Liquefied Natural Gas
NMHC	Non-methane hydrocarbon
NO _x	Oxides of nitrogen
NO	Nitric oxide
NO ₂	Nitrogen dioxide
O ₂	Oxygen
PM	Particulate matter
PI	Positive Ignition (Engine)
PPM	Part per million
RHC	Reactive Hydrocarbon
RMS	Root-mean square
S	Sulphur
THC	Total hydrocarbon

3 Exhaust Emission Limits, Applicability and Requirement

3.1 Exhaust Emission Limits

The emissions of the carbon monoxide, the emissions of hydrocarbons, the emissions of the oxides of nitrogen and the emissions of particulate matter and smoke obtained during emission certification and conformity of production emission test/s conducted in accord with in Annexure 7 of this regulation considering applicable deterioration factor, adjustment factor, shall not exceed the amount shown in Table 1 below:

Table 1
Emission limits for Genset engines up to 800 kW Powered by CI engines

Power Category, kW	Ignition type	NOx	HC	NOx +HC	CO	PM	Smoke
P ≤ 8	CI	-	-	7.5	3.5	0.30	0.7
8 < P ≤ 19	CI	-	-	4.7	3.5	0.30	0.7
19 < P ≤ 56	CI	-	-	4.7	3.5	0.03	0.7
56 < P ≤ 560	CI	0.40	0.19	-	3.5	0.02	0.7
560 < P ≤ 800	CI	0.67	0.19	-	3.5	0.03	0.7

Speed operation	Emission Test Cycle
Constand speed engine	D2 5-mode Steady-state discrete mode test cycle specified in ISO-8178-Part 4 OR D2 5-mode Steady-state ramped mode test cycle specified in ISO-8178-Part 4
Variable speed engine	C1 8-mode Steady-state discrete mode test cycle specified in ISO-8178-Part 4 OR C1 8-mode Steady-state ramped mode test cycle specified in ISO-8178-Part 4 OR 5-mode Variable Speed Cycle as specified Appendix 9 of Annexure 7
<i>Manufactures shall declare in TA application his choice of discrete-mode type or RMC type cycle for each family. The chosen cycle type shall also be applicable for all the child rating within family and not allowed to alter or further choice during COP. RMC type cycle is more relevant to determination the infrequent regeneration adjustment factor (IRAF) for the engine equipped with exhaust after-treatment systems that are regenerated on an infrequent (periodic) basis. Test agency may suggest RMC type cycle in case it is difficult to determine IRAF on discrete-mode type cycle for some cases</i>	

Notes:

- (a) The above limits are applicable for constant speed & variable speed engine
- (b) Smoke shall not exceed above value mentioned in tables above (where applicable) throughout the operating load points of the test cycles.
- (c) The testing shall be done as per test procedures mentioned in Annexure 7.
- (d) Every manufacturer, importer or assembler (hereafter referred as manufacturer) of the engine for genset application manufactured or imported into India shall obtain Type Approval and comply with Conformity of Production (COP) requirements of their product(s) for emission limits which shall be valid for next COP year.
- (e) The above-mentioned limit shall be applicable to Type approval and Conformity of Production (COP) carried out by authorized test agencies.

The term 'COP year' means the period from 1st July of a calendar year to 30th June of the following year

- (f) HC* - NMHC shall be considered for dual fuel operation in case of natural gas or RHC in case of LPG

Note: THC shall be considered for dedicated diesel engines
 NMHC = THC – CH₄ for natural gas dual fuel operation
 RHC = 0.5 X THC for LPG dual fuel operation

3.2 Rounding off

Determine the official emission result for each pollutant to at least one more decimal place than the applicable standard. Apply the deterioration factor to the official emission result, then round the adjusted figure to the same number of decimal places as the emission standard. Compare the rounded emission levels to the emission standard for each emission-data engine. In the case of NOX+NMHC standards, apply the deterioration factor to each pollutant and then add the results before rounding. Test report shall have both, the final rounded certificate emission result and adjusted test result before rounding for better clarity on the decision.

Use the following rounding convention

- i. If the first (left-most) digit to be removed is less than five, remove all the appropriate digits without changing the digits that remain. For example, 3.141593 rounded to the second decimal place is 3.14.
- ii. If the first digit to be removed is greater than five, remove all the appropriate digits and increase the lowest-value remaining digit by one. For example, 3.141593 rounded to the fourth decimal place is 3.1416.
- iii. If the first digit to be removed is five with at least one additional non-zero digit following the five, remove all the appropriate digits and increase the lowest-value remaining digit by one. For example, 3.141593 rounded to the third decimal place is 3.142.
- iv. If the first digit to be removed is five with no additional non-zero digits following the five, remove all the appropriate digits, increase the lowest-value remaining digit by one if it is odd and leave it unchanged if it is even. For example, 1.75 and 1.750 rounded to the first decimal place are 1.8; while 1.85 and 1.850 rounded to the first decimal place are also 1.8. Note that this rounding procedure will always result in an even number for the lowest-value digit.

Examples-

#	1	2	3	4	5	5	5	6	
1	Measured value -PM	0.0047	0.0048	0.0142	0.0143 (odd)	0.0238 (even)	0.0239	0.0333	0.0334
2	Emission Limit -PM	0.02	0.02	0.02	0.02	0.02	0.02	0.02	0.02
3	DF applicable	1.05	1.05	1.05	1.05	1.05	1.05	1.05	1.05
4	DF incorporated adjusted emission	0.0049	0.0050	0.0149	0.0150	0.0250	0.0251	0.0350	0.0351
5	Final certificate emission value	0.00	0.01	0.01	0.02	0.02	0.03	0.03	0.04
6	Decision Pass/Fail	Pass	Pass	Pass	Pass	Pass	Fail	Fail	Fail

Note: Rounding Reference taken form US EPA Regulation 40 CFR -1039 and 40 CFR- 1065

3.3 In addition, the following requirements shall apply:

- a) **Off cycle emission** for electronically controlled **constant speed** Compression Ignition engines & Dual Fuelled engines of all power categories when emission of gaseous and particulate sampled within the applicable control area shall not exceed the applicable emission limit values

by a factor of 2.0. (i.e., 2 times the emission limits) as set out details in Appendix 2 of Annexure 7 of this Regulation

- b) **Ammonia emission** over the test cycles for engines equipped with SCR shall not exceed a mean value of 25 ppm for engine power category less than or equal to 56 kW and 10 ppm for engine power category above 56 kW as set out details in Appendix 7 of Annexure 7 of this Regulation
- c) **Engine Durability Period and Deterioration Factor** shall be applicable to above 19 kW power category only as set out in details in Appendix 6 of Annexure 7 of this Regulation in details.

Engine Durability Period

Category (Power Band)	Emission durability period (hours)
>19 ≤ 56 kW (constant speed Engines)	3000
>19 ≤ 56 kW (Variable speed Engines)	5000
> 56 kW (All engines)	8000

Note: DF determined during type approval will be carried over.

Category (Power Band)	Deterioration Factors (DF)			
	CO	HC	NOx	PM
>19 kW (Constant / Variable Speed Engine)	1.3	1.3	1.15	1.05

Assigned multiplicative deterioration factors

Note: When opted for assigned multiplicative DF, no verification is required.

- d) **NOx control measures:** Engines which rely on the use of any external devices and or reagent (e.g. urea for SCR) in order to reduce emissions, shall ensure the correct operation of NOx control measures as set out in details in Annexure 8 of this Regulation in details
- e) **Particulate control measures:** Engines which rely on the use any external devices and or exhaust after treatment devise to reduce Particulate Matter emissions, shall ensure the correct operation of PM control measures, as set out in details in Annexure 8 of this Regulation in details
- f) **Infrequent Regeneration Adjustment factor (IRAF)** shall be applicable for the engine above 19 kW power category equipped with exhaust after-treatment systems that are regenerated on an infrequent (periodic) basis as set out details in Appendix 8 of Annexure 7 of this Regulation.
- g) **Gross Power & Speed tolerance:** The gross declared power of the engine shall be measured on the test bench at rated speed of engine. The measured power and speed may differ from the power and speed declared by manufactured as specified below.

Case	Gross Power Tolerance		Speed Tolerance	
	Constant speed	Variable speed	Constant speed	Variable speed
Type Approval	± 5% at rated for single cylinder engines ± 4% at rated for others engine		± 1% at rated	± 1% at rated & all part load points
CoP	± 6% at rated for single cylinder engines ± 5% at rated for others engine			

- h) **Crankcase ventilation requirement** shall be applicable to above 56 kW power category engines as set out details in Appendix 5 of Annexure 7 of this Regulation
- i) **Control Conditions-Altitude, Temperature:** Electronically controlled engine using auxiliary emission control strategy shall demonstrate the compliance requirement over control conditions at type approval as set out details in Annexure 8 of this Regulation. This clause is applicable to for power band above 56 kW electronically controlled engine using auxiliary emission control strategy to operate in altitude.

- j) Additional requirement for dual fuelled engine shall be applicable as set out details in Annexure 10 of this Regulation
- k) Additional requirement for variable speed engine shall be applicable as set out details in Appendix 10 of Annexure 7 of this Regulation (demonstration/ determination/ verification of declared speed values for emission test cycle)

Summary of the requirement:

Requirement	Power Category, kW		
	$P \leq 19$	$19 < P \leq 56$	$56 < P \leq 800$
Deterioration Factors (DF)	N/A	Yes	Yes
Crankcase emission	N/A	N/A	Yes
Adjustment factor (IRAF)	N/A	Yes ^a	Yes ^a
Off cycle emission-Control area	Yes ^b	Yes ^b	Yes ^b
Ammonia emission	Yes ^c	Yes ^c	Yes ^c
NOx control measures	Yes ^{c1}	Yes ^{c1}	Yes ^{c1}
Particulate control measures	Yes ^d	Yes ^d	Yes ^d
Control conditions-Altitude, Temperature	N/A	N/A	Yes ^e
Telematics for remote monitoring	N/A	N/A	Yes ^f

^a Applicable for engine with exhaust after-treatment systems that are regenerated on an infrequent (periodic) basis

^b Applicable for electronically controlled constant speed & variable speed engines

^c Applicable for SCR engine using reagent to reduce NOx emissions

^{c1} Applicable for engines using electronic control on devices which are used to reduce NOx emission, (i.e. EGR, SCR)

^d Applicable for engine using exhaust after treatment devise to reduce Particulate emissions

^e Applicable for electronically controlled engine using auxiliary emission control strategy to operate in altitude. Demonstration is only at time of type approval only once and not applicable during COP.

^f Applicable for electronically controlled constant speed & variable speed engines

4 Type Approval Administrative Procedure

4.1 Engine type and Engine family

4.1.1. Engine type

The technical features of an engine type shall be those defined in its information document drafted in accordance with the template set out in Annexure 1.

4.1.2. Operating mode (speed operation)

An engine type may be type-approved as a constant speed engine or as a variable speed engine, as defined of this Regulation.

4.1.2.1. Variable speed engines

For a variable-speed engine of a category, the parent engine (for the purposes of type-approval) and all engine types within the engine family (for the purposes of conformity of production), shall be tested using the applicable test cycle as described in this regulation.

4.1.2.2. Constant speed engines

The manufacture shall declare in his application the operation of engine is constant speed or variable speed.

4.1.2.3. Constant speed engine types equipped with alternative rated speeds

A constant speed engine shall not be designed to operate with variable speed. In the case that the engine type is equipped with alternative speeds the requirements of this paragraph shall additionally be met.

In the case that the engine type is the parent engine, the engine shall meet the applicable limit values when tested using the applicable constant speed test cycle at each constant speed applicable to the engine type. Separate test reports shall be produced and included in the information package for each emission test.

In the case of all engine types within the engine family, when subject to a conformity of production emissions test the engine shall meet the applicable limit values using the applicable constant speed test cycle at each constant speed applicable to the engine type.

Each constant speed applicable to the engine type that is permitted by the manufacturer shall be listed in information document as per Annexure 1

The engine shall be installed in a manner to ensure that:

- (a) the engine is stopped prior to resetting the constant speed governor to an alternative speed; and,
- (b) the constant speed governor is only set to the alternative speeds permitted by the engine manufacturer.

The instructions to the GOEM and end-users set out in Appendices A.1 and A.2 to Annexure 9 of this Regulation shall include information on the correct installation and operation of the engine according to the requirements of this Annexure.

4.1.3. Engine family criteria

4.1.3.1. General

For the purpose of type approval and conformity of production certification, the manufacturer engine range shall be divided into model families consisting of parent engine and its variant(s).

In case of import of complete genset, all the provision of this document shall be applicable to the engine which form part of the genset.

Engine family shall be the grouping of engines, which through their design are expected to have similar exhaust emission characteristic where member of the family shall comply with the applicable emission values.

Parent engine shall be the engine selected from the engine family, in such a way that it will incorporate those features which will adversely affect the emission level of the relevant exhaust emission.

4.1.3.2. **Engine family formation & choice of the parent engine**

Essential characteristic of the engine family, the parameters defining the engine family, the determination of an engine family and the criteria for choosing the parent engine shall be taken according to the guideline given in ISO 8178-7 Reciprocating internal combustion Engine-Exhaust Emission Measurement-Part-7: Engine family determination. However, the decision of selection of parent engine and family classification by the authorized test agency shall be final.

For the purpose of identification, the manufacturer shall designate the families as F1, F2, F3... Fn.

The manufacturer shall provide to the type approval authority the appropriate information relating to the emissions levels of the members of the engine family

4.1.3.3. **Dual-fuel engines**

All engine types within a dual-fuel engine family shall belong to the same type of dual-fuel engines defined in Annexure 10 of this Regulation (for example type 1A, type 2B, etc.), and operate with the same types of fuel or when appropriate with fuels declared according to this Regulation as being of the same range(s).

In addition to belonging to the same dual-fuel type, they shall have a maximum gas energy ratio on the applicable test cycle (GER_{cycle}) within the range 70 to 100 per cent of that of the engine type with the highest GER_{cycle} .

4.2 **Selection of Certifying Agency**

4.2.1. Following test agencies are currently approved by the Nodal Agency Central Pollution Control Board (CPCB) for purpose of type approval and subsequently conformity of production compliance process and may be revised from time to time.

- (a) Automotive Research Association of India (ARAI, Pune)
- (b) International Centre for Automotive Testing (ICAT, Manesar)
- (c) Indian Institute of Petroleum (IIP, Dehradun)

4.2.2. One supplier shall submit application for Type Approval to only one certification agency for all its families / models out of those approved.

4.2.3. The same certification agency shall be responsible for carrying out the verification of Conformity of Production (COP) for that manufacture

4.2.4. For a new OEM or importer, selection of technical agencies for type approval certification and subsequently conformity of production shall be applicant's choice among the technical agencies published by central pollution control board (CPCB) in paragraph 4.2.1 and as amended from time to time.

4.2.5. For any reason if any manufacturer wants to change the certification agency, he shall apply to the nodal agency well in advance with justifiable reason. The nodal agency, after consultation with the existing certification agency/ standing committee, may approve the change, if found justified. If approved, the nodal agency shall inform to the parties concerned.

4.2.6. On receipt of information for change in certification agency from the nodal agency, the previous certification agency shall authenticate all the relevant document of the model (type approval as well as COP verification) and forward the same to the new certification agency. The certification agency shall be responsible for carrying out the type approval testing and COP verification for the manufacturer, in future.

4.3 Application of type approval

- 4.3.1 The application shall be made in the format prescribed in **Appendix -1** and must be complete in all respect. **Appendix -1** shall be submitted to nodal agency and on its written acceptance, engine specification related documents to be submitted to the test agency.
- 4.3.2 The application for approval of an engine or an engine family with regard to the level of the emission of gaseous and particulate pollutants shall be submitted by the engine manufacturer or by a duly accredited representative.
- 4.3.3 For each engine family, the manufacturer must submit an application to the certification agency, selected as above.
- 4.3.4 The application must be signed by the authorized representative of the manufacturer.
- 4.3.5 It shall be accompanied by the undermentioned documents and the following particulars:
A description of the engine type comprising the particulars referred to in clause 4.1. of this Regulation and if applicable the particulars of the engine family as referred to in paragraph 4.1.3. to this Regulation. For the purpose of identification, the manufacturer shall designate the engines families as F1, F2, F3 Fn in consultation with technical agency;
- 4.3.6 Testing of the parent model, shall, normally, be sufficient for type approval of the family. The Testing agency has the option to carry out the testing of more than one model in the family to satisfy itself, subject to parent engine-concept as per ISO 8178-7
- 4.3.7 An engine conforming to the engine type characteristics described in clause 4.1. shall be submitted to the Test Agency responsible for conducting the approval tests. If the Test Agency determines that the submitted engine does not fully represent the engine family described in clause 4.1, an alternative and, if necessary, an additional engine shall be submitted for test
- 4.3.8 During Type Approval test, the manufacturer shall submit the qualified emission test data of all the remaining variant engines, other than the parent engine, which is chosen for emission test by the test agency of the family along with all other documents. Qualified emission data can be an emission test recorded at OEMs facility. This is required only for reference of test agency for future COP testing and it will not be part of Type Approval certification documents.
- 4.3.9 At later stage if the manufacturer submits the application for type approval of a model, the Testing agency shall ascertain whether the model can be classified as belonging to a family of model(s) already certified. If the model does not belong to a family already certified, the Testing agency shall proceed with the testing of the model for type approval with issuance of new and unique engine emissions family certification upon qualification;
- 4.3.10 If the model belongs to a family already certified, the Testing agency shall decide whether the specific testing of the model is required. In case the specific testing of the model is not required, the type approval certificate for the family may be extended to include the model. In such case qualified emissions data shall be submitted to agency by manufacturer during application;
- 4.3.11 The Testing agency shall intimate its decision to the applicant within a fortnight of receipt of the application, indicating need and plan (schedule) of testing for type approval;

4.4 Type Approval

- 4.4.1. No person or agency shall sale, import or use an engine for Genset application in India without valid Type Approval Certificate and Conformity of production Certificate referred to in clause 4.5. and 5.4 of this Regulation;
- 4.4.2. No person or agency shall sale, import or use a Genset in India containing an Engine without valid Type Approval Certificate and Conformity of production Certificate referred to in Clause 4.5. and 5.4 of this Regulation;
- 4.4.3. In order to receive a type approval of an engine type or engine family, the manufacturer shall demonstrate compliance, of the engine type or engine family with the provisions of this Regulation. The manufacturer shall also ensure the use of fuels as specified in Annexure 6.
- 4.4.4. All the type approval tests shall be conducted in the technical agency laboratory. In case the required test facilities are accredited by the technical agency, the type approval and / or COP tests can be carried out at manufacturer's laboratory also if reasons call for. In case the test is to be carried out at any overseas test facilities, the same shall be informed to the Nodal Agency by technical agency. The technical agency will submit a copy of accreditation letter highlighting the details of test facilities available in the manufacture's laboratory to the Nodal Agency;
- 4.4.5. In case of the manufacturer approaches the technical agency for the first time, such manufacturer should complete the COP test(s) within three months from the commencement of commercial production or importation of 100 units. In case, manufacturing or import is done in reference to a specific order or requirement for one time, the supplier has to make available full quantity or as required for COP sampling as per the procedure laid down in this regulation. Type Approval should be conducted on the random selection and its validity shall be limited to same COP year.
- 4.4.6. The manufacturer may use of commercial fuels or reference fuels set out in Annexure 6, provided to be declared in the information document.
- 4.4.7. Additionally, in order to receive type approval of a Genset with an approved engine with regard to emissions or a type approval of a Genset with regard to emissions the manufacturer shall ensure compliance with the installation requirements set out in Annexure -9
- 4.4.8. The Type Approval Authority shall put together an information package consisting of the information folder accompanied by the test report and all other documents added by the technical service or by the Type Approval Authority to the information folder in the course of carrying out their functions ('the information package'). The information package shall include an index listing its contents, suitably numbered or otherwise marked so as to clearly identify all the pages and the format of each document, in order to present a record of the successive steps in the management of the type approval, in particular the dates of revisions and updating;
- 4.4.9. The approval authority shall ensure that the information contained in the information package is available for a period of at least 10 years following the end of the validity of the type approval concerned;

4.5 Certificate of Type Approval and Validity

- 4.5.1. After verification of engine(s) for the type approval, the technical agency shall issue a type approval report to manufacturer within one month from date of testing completion indicating acceptance or rejection decision and reason thereof. If the engine(s) submitted for approval pursuant to clause 4.3. of this Regulation. Approval of that engine type(s) or engine family(ies) shall be granted by the technical agency through issue of Type Approval Certificate as per format prescribed in Annexure 2 along with report. Copy of the certificate and report shall be forwarded to Nodal Agency by technical agency involved;
- 4.5.2. For the purposes of clarity and easing access to relevant data, the communication includes an addendum containing the most relevant information related with the type-approved engine type or engine family;
- 4.5.3. The certificate shall be deemed to be valid for the model(s) included herein, unless explicitly withdrawn by separate written order by the Nodal Agency;

- i) unless explicitly withdrawn by separate written order by the Nodal Agency; or
- ii) failed to conduct COP within prescribed time and/or production/ import quantity limit;

This need to be mentioned in the Type Approval Certificate

- 4.5.4. The Type Approval certificate for an engine family issued to the manufacturer shall be valid for the same model(s) manufactured at any other manufacturing plant of the same manufacturer. The Nodal Agency or technical agency concern with type approval may visit the new plant to verify adequacy of the infrastructure;
- 4.5.5. Validity of Type Approval Certificate issued by type approval authority shall remain valid for 'current' COP-year enabling sales of such type approved engine family for that duration;
- 4.5.6. Validity of Type Approval Certificate issued by type approval authority shall remain valid further as long as following conditions are met:
 - i) Till the engine specifications change as mentioned in Annexure 1 and modification related clauses described in clause 4.6 below;
 - ii) Till the further amendments to the notification;
 - iii) Till COP is not missed / Till COP procedure compliance per clause 5 is obtained within prescribed timeframe as listed in clause 5.3.10.
- 4.5.7. In case manufacturer has not sold engines in two subsequent COP-year period and has done appropriate 'Zero volume' declaration seeking COP exemption to nodal agency, and for resuming sale for third year of such engine family, manufacturer to conduct COP test before making any sell or a fresh new type approval application and subsequent process needs to be carried out. Refer clause 5.5 for COP certification.

4.6 Modification and Extensions of approved type

- 4.6.1. If an engine type or engine family is type approved and valid, manufacturer may approach type approval certificate issuing technical agency for modifications pertaining to parent or any engine type in the certified engine emissions family. Such modifications shall be ascertained by manufacturer utilizing guidelines described in clause 4.6.5
- 4.6.2. Manufacturer shall submit technical document in line with type approval procedure prescribed in this Regulation;
- 4.6.3. Subjected to scrutiny of manufacture's application, technical agency shall approve or seek more data pertaining but not limited to engine architecture, parameters, similarity with existing engine type from emissions and performance perspective along with evidences. Decision of technical agency will remain finally binding for allowing such amendments to existing type approval certificate of an engine family through extension(s) vs asking manufacturer to type approve as new engine family or new engine type;
- 4.6.4. Technical agency retains all rights to ask manufacture to demonstrate modified engine type for emissions conformity through applicable type approval test procedures. Submission of manufacturer run emissions data with valid test facility and procedure followed is mandatory where changes are directly or indirectly pertaining to emission affecting components, engine and after treatment system control algorithms and engine performance specifications.
- 4.6.5. Following generic rules may be utilized as example for extensions of type approval certificate:
 - 4.6.5.1. **No emission test requirements necessary:**
 - (a) change to part numbers declared through type approval documentation that is not emission affecting;
 - (b) part number change of emission affecting component that is just an administrative change supported with due declarations (proto to production Part number change as an example);

(c) change(s) to emission strategy for engine operation beyond altitude and temperature conditions prescribed by this Regulation however with due declaration with technical agency in this regard;

4.6.5.2. Emission test compliance required:

(a) performance or specification or source change of a component declared through type approval documentation that is emissions affecting. This applies to any such component in engine and after treatment system including software;

(b) emissions strategy changes such as but not limited to fuelling timing, fuelling qty, fuelling modes, reagent dosing, regeneration timing;

(c) addition of alternate source component that is emission affecting with or without part number change;

4.6.5.3. Emission and NOx and / or Particulate Control Diagnostics compliance required:

(a) in addition to clause 4.6.5.2 at discretion of technical agency if changes to NOx and Particulate control diagnostics limits or strategy or software is carried out;

(b) NOx and /or Particulate control diagnostics demonstration method through failed part has been changed;

4.6.5.4. In the event of an extension the Test Agency shall establish an updated communication denoted by an extension number that shall be incremental in accordance with the number of successive extensions previously granted. That communication shall clearly show the reason for the extension and the date of extension.

4.7. Type Approval Process Flow-chart

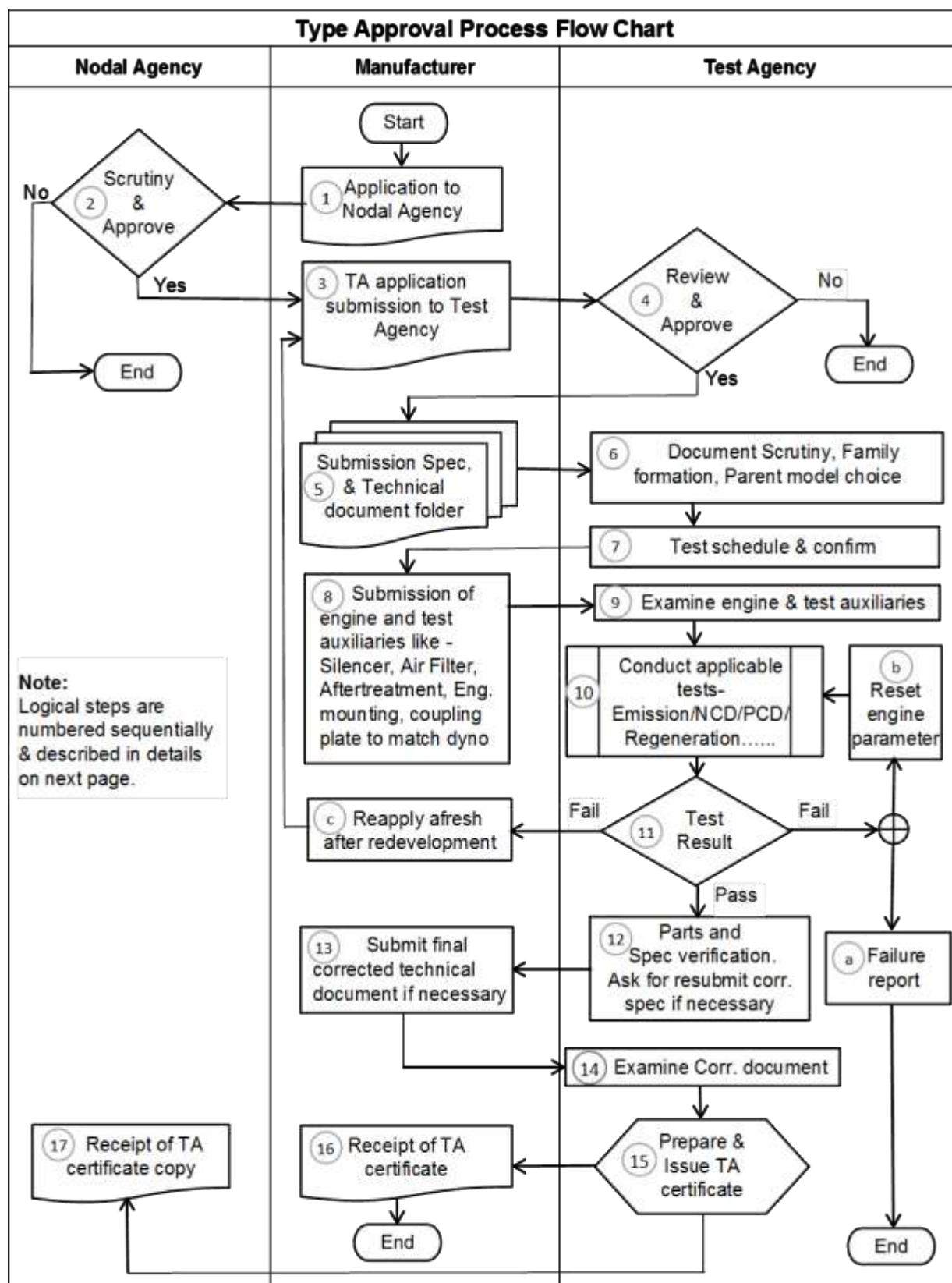

Following are the logical steps for the type approval process flow chart described in brief stepwise -

1. Application to nodal agency (CPCB) in the form of affidavit seeking permission for type approval of Genset engine family through submission provided as draft specimen in Appendix 1.
2. Upon written approval of nodal agency to manufacturer and chosen technical agency; (*This could be decision making node with "Yes" / "No" loop*)
3. Submit type approval certification application to chosen test agency. Based on provisions such application can be written or online through their secured portal;
4. Obtain technical agency approval (*This could be decision making node with "Yes" / "No" loop with NO means, provide additional data*)
5. Upon agencies application scrutiny and negotiations, submit detailed technical documentation as per requirements described in Annexure 1;
6. Obtain documentation approval from technical agency, family formation, choice of parent engine, provide additional data
7. Obtain test plan / schedule from technical agency
8. Upon approval from technical agency plan for providing engine test auxiliaries like -Silencer, air filter, after treatment systems, engine mounting, coupling plate to match dyno, components for NCD/PCD demonstration etc.
9. Upon receipt of engine along with auxiliary technical agency examine the adaptability in test cell, make necessary modification in exhaust line, mounts, etc, if required.

In case of dual fuel engines, certificates of the NG/LPG fuel system components as per Appendix A.4 of Annexure 10 to be validated from test agency. In absence of valid component certificate, the component to be tested and approved from test agency as per applicable standard
10. Conduct applicable tests-
 - 10.1. Conduct emissions test to qualify (*This could be decision making node with "Pass" / "Fail" loop. "Fail" means, a) current TA application is closed out with failure report b) adjust. reset engine parameter for retest or c) further manufacturer may re-apply afresh after redevelopment*)
 - 10.2. Conduct NCD and PCD demonstration tests to comply (*This could be decision making node with "Pass" / "Fail" loop. "Fail" means, a) current TA application is closed out with failure report b) adjust. reset engine parameter for retest or c) further manufacturer may re-apply afresh after redevelopment*)
 - 10.3. Demonstrate results related to infrequent regeneration, control condition if applicable;
11. Review of all test results with manufactures and decision about compliance, in case of failure manufacture have three options to proceed a, b, & c, act accordingly.
12. Technical agency carries out part verification of critical engine components and injection timing verification in compliance with document submission, take final review of technical document and ask manufacture to resubmit if necessary
13. Manufacture submit the corrected technical document if found necessary
14. Examine corrected document submitted in line with the requirement
15. Technical agency prepares technical report based on tests;
16. Technical agency issues type approval certificate to manufacturer;
17. Technical agency forwards a copy of type approval certificate to nodal agency

End

Appendix – 1

Application to Nodal Agency. Specimen for Submission of Affidavit & Profile details of manufacturer

Part - A

NOTARISED AFFIDAVIT ON NON-JUDICIAL STAMP PAPER OF VALUE RS 10/- OR ABOVE

[To be submitted to the Nodal Agency by a supplier approaching for the first time for TA]

I,, Chairman / President / Managing Director / Partner / CEO / COO / Proprietor of M/s, having Registered Office at engaged in manufacturing / import of Genset diesel/Duel fuel engines / Diesel/duel fuel Generator sets with manufacturing facilities / ware house at:

i)

ii)

am authorized to swear this affidavit for and on behalf of the above named Company. I do hereby solemnly affirm and declare as under:

1. That the deponent is well conversant with the facts and competent to swear this affidavit.
2. That the deponent declares that M/s are manufacturer / importer of Genset diesel engines in the brand name

i)

ii)

(Strike out if not applicable)

3. That the deponent declares that M/s are importer of diesel generator sets from M/s i) (ii) M/s (Complete address)
(Strike out if not applicable)

4. That the deponent declares that M/s will obtain Type Approval / Conformity of Production verification only from (Name of the Certification Agency) and will not approach any other Certification Agency for Type Approval / Conformity of Production verification for any of their Genset diesel engines models, without prior permission from the nodal agency.

5. That the deponent declares that none of the Chairman, Managing Director, Partner, Director, Proprietor, Board Member in M/s has been involved with a Company / Firm which has manufactured and sold non-compliant Genset diesel engines.

6. That the deponent declares that M/s will manufacture / import and sell only compliant Genset diesel engines

(Name & signature with Co. stamp)

(DEPONENT)

VERIFICATION

Verified at on thisof20..... that the contents of the above affidavit are true and correct to the best of my knowledge and belief and nothing has been concealed therein.

Place:

Date.....

(Name & Signature with Co. Seal)

(DEPONENT)

Part - B

Format for Submission of Profile and Details of the Supplier

A. Company details

- Name of the Company
- Type of Company: Proprietor / Partnership / Private Ltd / Public Ltd
- Name of the Proprietor / Partners / Directors (submit relevant documents)
- Importer / manufacturer
- Registered Office Address with phone number
- Contact Address with phone number, fax number, email etc.
- Name and designation of the authorized person for submission of documents and to deal with the certification agency
- Plant addresses and contact details, in case of manufacturer
- Ware house address, in case of importer (This cannot be changed without prior intimation to Nodal Agency and Certification Agency)
- Name of the company from whom to import and its contact details, in case of importer
- Plant details, from where to import
- Authenticated Copies of following documents to be submitted
 - i) DIC/ Udyog Adhar/ Udyam Adhar/ Manufacturing License from Directorate of Industries / Department of Industry (in case of Manufacturer), IEC Code (in case of importer)
 - ii) GST Registration
 - iii) Excise Registration, in case of manufacturer
 - iv) Consent from State Pollution Control Board/ Pollution Committee
- No. of employees
- Engineers (if any)
- Last year Turn-over
- Any other business

B. Details of Genset engine (Proposed) manufactured / assembled / imported

Sr No	Model Names	Nos. produced /imported in current year	Nos. expected to be produced / imported in the next year
a			
b			
c			
d			

C. Details of Infrastructure

D. Land: Owned / Rented
Area (m²):

E. Covered Area

F. Machinery for manufacture

- a)
- b)

c)

d)

G. Testing facility equipment's

a) Load bank type and capacity

b) Measuring Instruments

c) Any other

H. Quality Control

1. Quality Control In charge

2. Quality Procedure:

ISO Certified since when (Enclose a Copy of Operating Procedure)

3. Pre-delivery Inspection Procedure on Gensets (including records maintained)

4. System of serial numbering and marking on Genset and their sub-systems – e.g. all Enclosures, etc.)

5. Any other

Date:

Place:

SIGNATURE OF THE
(Chairman /President / Managing Director
/ Partner / CEO / COO / Proprietor)

SEAL OF THE COMPANY

---End---

5 Conformity of Production Administrative Procedure

5.1 General

- 5.1.1. Conformity of Production (COP) compliance is designed to ensure manufacture's compliance and control towards a type approved genset engine family to statistically ensure engines sold under such emission certification does meet required emissions and other requirements including NOx and / or Particulate diagnostics provisioned by this Regulation;
- 5.1.2. COP process compliance also ensures type approval certificate validity and hence right to produce and sale genset engines by a manufacturer owing such type approval certification for the next COP-year. Such provision is administratively provided by issuing Conformity of Production Certificate;
- 5.1.3. Each manufacture shall subject it's engine model range to the verification of COP, every year. For this, the year shall mean the period from 1st July of the calendar year to 30th June of the succeeding calendar year;
- 5.1.4. Each manufacturer shall subject engine model(s) for NOx Control Diagnostics (NCD) and / or Particulate Control Diagnostics (PCD) compliance test representative of it's NCD and or PCD family as declared during type approval certification for it's entire genset engine model range. Depending on engine types certified, a manufacturer may need to submit apt and separate representation of engine types representing NCD and / or PCD families. Such demonstration and compliance shall be required once per COP-year per NCD and /or PCD family.
- 5.1.5. For this, the year shall mean the period from 1st July of the calendar year to 30th June of the succeeding calendar year;

5.2. Verification of Conformity of Production (COP)

5.2.1. COP of domestically manufactured engine families' up to 19 kW:

- 5.2.1.1. In case engines up to 19 kW power rating, the verification of COP shall be done once in a COP-year as per plan described in following 'Table 1'

Table 1

Number of families to be tested for verification of COP for domestic manufactures (for engines up to 19 kW)

Total number of families of the domestic manufacturer	Total number of families to be tested per year
1– 3	1
4 – 7	2
8 – 11	3
12 – 15	4
>15	5

5.2.2. COP of domestically manufactured engine families more than 19 kW rated output and imported engines of all rating:

Domestically manufactured engines of more than 19 kW rated output and imported engines of all ratings shall be subjected to the verification of COP once for every 1000 units per family or once a year, whichever is earlier;

- 5.2.3. Domestically manufactured engine models(s) and imported engines of all ratings shall be subjected to the verification of NCD and / PCD once every COP-year by NCD and/or PCD family(ies)

representative engine(s). Such demonstration is NCD/PCD family dependant and irrespective of combined volumes produced and sold under such family(ies).

5.3. Sample size, Decision and Other Criteria for verification of COP

- 5.3.1. In case of engines defined in clauses 5.2.1.and 5.2.2. above, testing shall be done on sample(s) randomly selected by certification agency from the production line / import warehouse, of one model for each family selected for COP.
- 5.3.2. In case of engines defined in clauses 5.2.3. above, testing shall be done on sample(s) randomly selected by certification agency from the production line / import warehouse for NCD and / or PCD compliance;
- 5.3.3. In case engines up to 19 kW power rating, a minimum quantity of 10 numbers or one day's average production volume of the engine model selected by technical agency, whichever is more shall be made available for random selection. Same criteria shall apply to random selection of after treatment system that is not integrated with engine system;
- 5.3.4. In case of domestically manufactured engines more than 19 kW power rating, a minimum one day's average production volume of the engine model selected by technical agency, shall be made available for random selection subject to minimum quantity of 3. This limit shall not be applicable in case of import of all ratings. Same criteria shall apply to random selection of after treatment system that is not integrated with engine system;
- 5.3.5. If the manufacturer is not of Indian origin, the manufacturer should establish a base office in India, which is to be declared in the initial application submitted to Nodal Agency as per Appendix 1 This base office will be responsible for Type Approval and COP compliance;
- 5.3.6. The manufacturer shall request the certification agency when they would like to make random selection of engine(s) and to seek their schedule / availability for completing the COP test;
- 5.3.7. COP verification shall be carried out for each plant of the domestic manufacturer. For imported engines, the COP testing shall be carried out on the engine manufactured for each country of origin irrespective of engine family being same;
- 5.3.8. The certification agency shall intimate to the manufacturer the schedule (month) of sampling / testing. The manufacturer shall inform the production/ import plan for the month in which the technical agency wants to carry out the COP, to the technical agency. If the manufacturer has a problem due to particular reasons such as the particular model is not likely to be scheduled for production / import at that time, or enough number of engines may not be available for random selection; the time schedule may be modified based on mutual convenience of the manufacturer and the technical agency;
- 5.3.9. The manufacturer shall complete all COP activities (such as random selection, initial running-in, emission testing, NOx and/or Particulate Diagnostics testing and documentation) at least one month before the end of COP-year. The COP certificate shall not be issued in case of non-adherence to above schedule unless such schedule attainment is due to unavoidable reasons such as but not limited to test facility downtime, extended COP process encountered.
- 5.3.10. Following 'Table 2' gives the deadlines for the respective COP-year for the COP activities. However, manufacturer can take early action on each activity to ensure compliance.
- 5.3.11. Manufacturer must take early action on each activity for the families (more than 19 kW rated output) exceeding 1000 units of production to ensure the compliance of clause 5.2.2.

Table 2

Sr No	Activity Description	Last Date
1	Submission of production / import plan / actual details to test agency	1st March
2	Random Selection	1st April
3	Submission of engines and subsequent testing (Including extended COP if any)	31st May
4	Completion of documentation and COP Certificate issuance	30th June

- 5.3.12. The manufacturer shall inform the test agency regarding the stoppage of production of a specific model, in case this has not been anticipated at the start of the COP period. This shall be intimated well in advance so that COP selection of the engine can be completed by the technical agency before stoppage of production. Manufacture is held accountable for ensuring COP is conducted and samples are made available per requirements of this Regulation;
- 5.3.13. The manufacturer shall provide all the assistance required by the technical agency for completing the tests;
- 5.3.14. The latest updated technical specifications, procedure of pre-delivery inspection (PDI), running-in and servicing of the engine, shall also be submitted before the engine selection, if there have been revisions after the previous COP / type approval;
- 5.3.15. Pre-delivery inspection as per owner's instruction manual / service manual will be carried out by the manufacture as per procedure declared at the time of type approval and as amended and intimated to concern technical agency from time to time for the selected engine(s), under the control of technical agency;
- 5.3.16. The running-in of the engine(s) shall be carried out as per the manufacture's recommendation submitted during the type approval and as amended and intimated to the concern technical agency from time to time, for engine(s) under control of the technical agency. Running-in may also be carried out at engine manufacture's place under the control of technical agency provided adequate facilities are available. After such running-in procedure, manufacture will be permitted to carry out all the adjustments recommended in their owner's / service manual and as amended and intimated the concern technical agency from time to time published with technical agency, under the control of the technical agency;
- 5.3.17. In case of failure of any major component during the running-in or testing, the technical agency may permit to replace component only once; which has failed and which does not affect the performance and emission of the engine. Such decision is entirely with technical agency. In case of failure of emission affecting component, random selection of engine at manufacture's plant or warehouse shall be done afresh. If for such randomly selected engine (second time) or a replaced component fails again, it shall be reported to the nodal agency by the concern technical agency and agency shall await instructions from the nodal agency for further action;
- 5.3.18. The manufacture shall submit the randomly selected engine(s) to technical agency within four weeks (8 weeks in case of import subjected to last date as mentioned in clause 5.2.10. – Table 2) of completion of running-in for emission compliance test and NOx and / or Particulate diagnostics test where applicable. Manufacturer also shall supply appropriate 'failed' parts for NCD and/or PCD demonstration in line with agreement with technical agency during type approval certification and documentation;
- 5.3.19. The technical agency should endeavour to complete the required testing of selected engine(s) within four weeks after submission of engine(s);
- 5.3.20. The testing shall be done as per applicable procedures and specifications described in Annexure 7 with test facility compliant to requirements specified Annexure 4 while utilizing data evaluation and result calculation procedures described in Annexure 5 of this Regulation;

5.3.21. **Sampling plan for COP**

5.3.22. Sampling Plan-I is applicable to domestically manufactured engine upto 19 kW rated output whereas Sampling Plan-II is applicable to domestically manufactured engine above 19kW as well as for imported engines of all ratings (Imported as an engine or as a genset)

5.3.23. **Sampling Plan-I: Upto 19kW domestic**

5.3.23.1. The number of samples to be tested shall be minimum as necessary, as given in Table 3 to arrive at a decision on whether the production unit complies with applicable emission limits;

5.3.23.2. A sample said to have failed for particular criteria pollutant if the test result of the sample for the criteria pollutant exceeds required DF and IRAF (if applicable) corrected emission limit;

5.3.23.3. The production units of all models in the family shall be deemed to comply with the emission limits if the number of failed samples as defined in clause 5.3.23.2. above for each criteria pollutant is less than or equal to the pass decision number appropriate to the cumulative number of samples tested for that criteria pollutant as given in Table 3;

5.3.23.4. The production units of all models in the family shall be deemed to be non-complying with the emission limits if the number of failed samples as defined in clause 5.3.23.2. above for each criteria pollutant is more than or equal to the fail decision number appropriate to the cumulative number of samples tested as given in Table 3;

Table 3

Sampling plan I and decision criteria for the verification of COP of the engines

Cumulative Samples	Pass decision	Fail decision	Cumulative Samples	Pass decision	Fail decision
	No. of failure			No. of failure	
1	(a)	(b)	16	6	11
2	(a)	(b)	17	7	12
3	(a)	(b)	18	7	12
4	0	(b)	19	8	13
5	0	(b)	20	8	13
6	1	6	21	9	14
7	1	7	22	10	14
8	2	7	23	10	15
9	2	8	24	11	15
10	3	8	25	11	16
11	3	8	26	12	16
12	4	9	27	12	17
13	5	10	28	13	17
14	5	10	29	14	17
15	6	11	30	16	17

(a) : Series not able to pass at this stage

(b) : Series not able to fail at this stage

Note:

- i) COP compliance or non-compliance decision is on the basis of number of failures within the respective cumulative samples tested.
- ii) During successive testing, the decision which reached first is the final.
- iii) Minimum 4 samples are required to test to reach pass decision
- iv) Minimum 6 samples are required to test to reach fail decision

5.3.23.5. Once a compliance or non-compliance decision is made for a particular criteria pollutant, the result of testing of subsequent samples for that criteria pollutant shall not influence the decision;

5.3.24. Sampling Plan-II: Above 19kW & Imported all rating

- 5.3.24.1. One engine sample selected randomly shall be tested as per procedure described in Annexure 7 of this Regulation;
- 5.3.24.2. If the engine sample as tested fails to comply with the emission limits, the manufacturer may ask for measures to be performed on a sample of engines taken from the production series and including the engine originally tested. The manufacturer shall specify the size 'n' of the sample subject to 'n' being minimum of 3 and maximum of 10 inclusive of sample originally tested;
- 5.3.24.3. The production or import units of all models in the family shall be deemed to comply with emission limits if following condition is met for each criteria pollutant except for Smoke limits:

$$\bar{x} + k \cdot S < L$$

Where,

\bar{x} = arithmetic mean of the results of the tests conducted on 'n' number of samples, for a particular specie

S = Standard deviation of the results of the tests conducted on 'n' number of samples, for the specie = $[\sum (x - \bar{x})^2 / (n - 1)]^{1/2}$

x = results of the tests conducted on 'n' number of samples, for the specie.

L = the emission limit for the specie

k = a statistical factor dependent on 'n' number of samples and as given in below table.

Table 4

Values of Statistical Factor 'k' with respect to parameter 'n'

n	2	3	4	5	6	7	8	9	10
k	0.973	0.613	0.489	0.421	0.376	0.342	0.317	0.296	0.279

5.3.25. Miscellaneous failure during COP

- 5.3.25.1. **Smoke failure** : For verifying the conformity of production, if the selected engine does not meet the smoke limit as applicable, the another two engines in case above 19 kW power rating or four engines in case below 19 kW power rating, will be taken from the series at random and be tested as per this part. All these selected engines shall meet the limit values specified. One engine shall be subjected to the emission test for the conformance of production.
- 5.3.25.2. **Gross Power failure** : For verifying the conformity of production, if the selected engine does not meet the gross power and rated speed limit as applicable, the another two engines in case above 19 kW power rating or four engines in case below 19 kW power rating, will be taken from the series at random and be tested as per this part. All these selected engines shall meet the limit values specified. One engine shall be subjected to the emission test for the conformance of production.
- 5.3.25.3. **Off cycle emission failure** : For verifying the conformity of production, if the selected engine does not meet the off cycle emission limit criteria over control area as applicable, the another two engines in case above 19 kW power rating or four engines in case below 19 kW power rating, shall be taken from the series at random and be tested as per this part. All these selected engines shall meet the limit values specified. One engine shall be subjected to the emission test for the conformance of production.
- 5.3.25.4. **NCD / PCD demonstration failure** : For verifying the conformity of production, if the selected engine does not meet the compliance requirement with respect to NCD / PCD demonstration as applicable, the another two engines in case above 19KW power rating or four engines in case below 19KW

power rating, will be taken from the series at random and be tested as per this part. This selected all engines should meet the limit values specified. One engine shall be subjected to the conformance of production.

- 5.3.25.5. If further same failure noted in any of the additionally selected samples of clause 5.3.25.1, 5.3.25.2, 5.3.25.3 & 5.3.25.4, the production shall be considered as non-compliance and the provision of clause 5.8, shall be put into effect.

5.4. Certificate of Conformity of Production (COP) and Its Validity

- 5.4.1. After verification for COP, the certification agency shall issue a COP verification report to the manufacturer within one month of the date of testing completion, indicating compliance or non-compliance. In case of compliance, the technical agency shall issue a COP certificate to the manufacturer as per format prescribed in Annexure 2 along with report. At the end of CoP year, details of CoP & the copies of certificate as well as report shall also be forwarded to the Nodal Agency;
- 5.4.2. Certificate of conformity of production is required to commence the production and sale of domestic genset engines in immediately next COP-year. Validity of current COP certificate shall be till successful compliance of first COP test in next COP-year
- 5.4.3. In given COP-year for engine type(s) described in clause 5.2.2., successful compliance of COP for every 1000 engines invoiced by the manufacturer shall enable further production of 1000 engine(s) and thereafter, in case engine(s) volumes for a particular engine family exceed 1000 units annually;
- 5.4.4. The COP certificate will be issued at the end once all the numbers of engine samples demanded as per the production plan submitted become tested successfully. Intermediate COP certificate i.e at each sample tested shall not be issued, However the test data report will be issued at every test sample.

5.5. COP Discontinuity

- 5.5.1. If there is no production or import of model(s) of a particular engine family for two consecutive years immediately after obtaining type approval or immediately after obtaining COP certificate, the type approval certificate for that particular engine family becomes invalid. In case the manufacturer wants to manufacture or import engine model(s) of such particular engine family, then the manufacturer shall approach Nodal Agency and technical agency to obtain a new Type Approval certificate afresh following stated procedure;
- 5.5.2. If there is no production or import of model(s) of a particular engine family for two consecutive years immediately after obtaining type approval and if the COP test is requested for the third year, then the supplier shall approach Nodal Agency to obtain approval for the extension of validity of Type Approval. This is applicable only for a new manufacturer and in case no engine(s) sale has happened post type approval;

5.6. Exemption from COP

In the following cases, engine family(ies) shall be exempted from COP process.

- 5.6.1. If Type Approval obtained in the last quarter of COP year. This clause is not applicable to the manufacturer as mentioned in clause 4.4.5.
- 5.6.2. In case of no production or import, the manufacturer shall submit a declaration to technical agency and Nodal Agency for 'No production or import' of a particular family models for every COP-year;
- 5.6.3. The COP test shall be conducted by technical agency for the next COP-year, upon receipt of declaration by the manufacturer that there was no production or import during current COP-year;
- 5.6.4. Declaration in this regard should be submitted before end of third quarter of the current COP-year; (i.e 31st March), if produced after 31st March, COP is applicable.
- 5.6.5. Any genset engine manufactured for purpose of export outside India. COP exemption shall apply for such volumes and COP test exemption shall apply if all such engine(s) produced are exported;
- 5.6.6. Any domestically manufactured genset engine intended for the purpose of sample (Maximum number of 4 units per engine family) only and not for sale in India;
- 5.6.7. Any genset engine imported for the purpose of sample testing, bench making and not intended for any commercial sale (Maximum number of 4 units per year);
- 5.6.8. Any genset engine imported for the round robin or laboratory correlation tests. Such engines shall be exported back within 12 months from the date of import; or it should be scrapped and a scrap certificate shall be provided.
- 5.6.9. For obtaining exemptions regarding clauses 5.6.6, 5.6.7 and 5.6.8, the manufacturer shall obtain written approval from Nodal Agency.
- 5.6.1. For obtaining exemptions regarding 'No production or import' as per clauses 5.6.2, the manufacturer shall obtain written approval from Nodal Agency. Nodal agency should endeavor to respond within 4 week after the receipt of application.
- 5.6.2. COP exemption shall be maximum up to three consecutive COP year, to resume sell from fourth year a fresh type approval shall be conducted
- 5.6.3. After obtaining exemption as per 5.6.2, once production resume, manufacturer shall first conduct COP before making any sell.

5.7. Production Definitely Discontinued

- 5.7.1. If manufacturer decides to discontinue production / withdraw type approval certificate of a specific engine family or multiple families from a specific plant or all plants, the manufacturer shall so inform to Test Agency involved in type approvals and COP compliance at least three month before the stoppage of production;
- 5.7.2. In such case, the manufacturer shall ensure COP compliance for the engine family(ies) from every manufacturing plant before the production of the engine family(ies) is discontinued following COP compliance process described in clauses 5.1, 5.2, 5.3 and 5.4 of this Regulation;
- 5.7.3. Upon receiving the relevant communication, the Test Agency shall inform the manufacturer the acceptance of the communication and provide an acceptance letter.

5.8. Consequences of non compliance

- 5.8.1. If the COP verification report of the technical agency for a model family indicates non-compliance, the manufacturer must stop manufacturing with immediate effect;
- 5.8.2. Further, the manufacturer must analyze the reasons for non-compliance, plan to take corrective actions in design, production line and units already produced and submit a report to the nodal agency with a copy to concern technical agency within four weeks of the receipt of the COP verification report;
- 5.8.3. If the manufacturer is unable to diagnose the reasons for non-compliance within stipulated time, this shall be clearly stated in the report;
- 5.8.4. Based on the diagnostics and corrective action plan submitted by the manufacturer, the Nodal Agency in consultation with technical agency and if both decide to, in consultation with standing committee, may take any of the following actions:
 - 5.8.4.1. Allow continuation of production or import of all models in the family if it is satisfied with the corrective actions planned or taken by the manufacturer and ability to meet emission norms;
 - 5.8.4.2. Allow continuation of production or import of some or all other models of the engine family if it determines that the reasons for non-conformance of the tested model are not relevant to these models; with or without additional verification of COP in due course;
 - 5.8.4.3. Stop production or import of some or all other models of the engine family till compliance is demonstrated by the supplier, through a re-verification of COP. In case of imported model(s), the non-compliant genset should be sent back to the original destination;
- 5.8.5. The manufacturer shall be given an opportunity to explain its views before taking final decision;
- 5.8.6. It is responsibility of the manufacturer to ensure at his cost that the modifications are carried out such as field retro fitment campaigns within period specified by the Nodal Agency on all products produced as well as sold / dispatched in the period between the dates from which the COP became due and re-verification of COP or as decided by the Nodal Agency, in consultation with standing committee; As a guarantee from the supplier, it has to deposit a BG of RS 50.00 lacs with validity period of three years returnable after satisfactory compliance acceptable to Nodal Agency, forfeited otherwise. Further, in case of continuation of same model and/ or introduction of new model, the supplier has to submit additional BG of Rs 10.00 each valid for three years during above BG validity;
- 5.8.7. In case COP is missed, COP on the current date shall be permitted subject submission of a Bank Guarantee (BG) of Rs 10.00 lacs to Nodal Agency with observation period of three years and an undertaking to follow due compliance procedure regularly. During observation period, if product line is to be enhanced the same procedure is to be replicated. In case the same supplier misses COP again, BG amount shall be doubled to Rs 20.00 lacs. It is returnable after satisfactory compliance acceptable to Nodal Agency, forfeited otherwise.
- 5.8.8. Nodal Agency with help from Technical agency shall audits compliance in field on random basis for corrections done and issues closure letter to manufacturer
- 5.8.9. Further, to avoid such non-compliances again in future, following precautionary measures shall be initiated to strengthen the process which will be followed for next two COP cycle after re-certification & resuming the production with new modified spec;
 - a) COP compliance shall be established once for every 500 units of production
 - b) First COP compliance to be established before crossing 50 units of production once production resume with modified spec.
 - c) COP activities to be completed in all by 31st March every COP year for the next three years. After 3-year, COP shall be as per normal practice/timeline.

5.9 COP Process Flow Chart

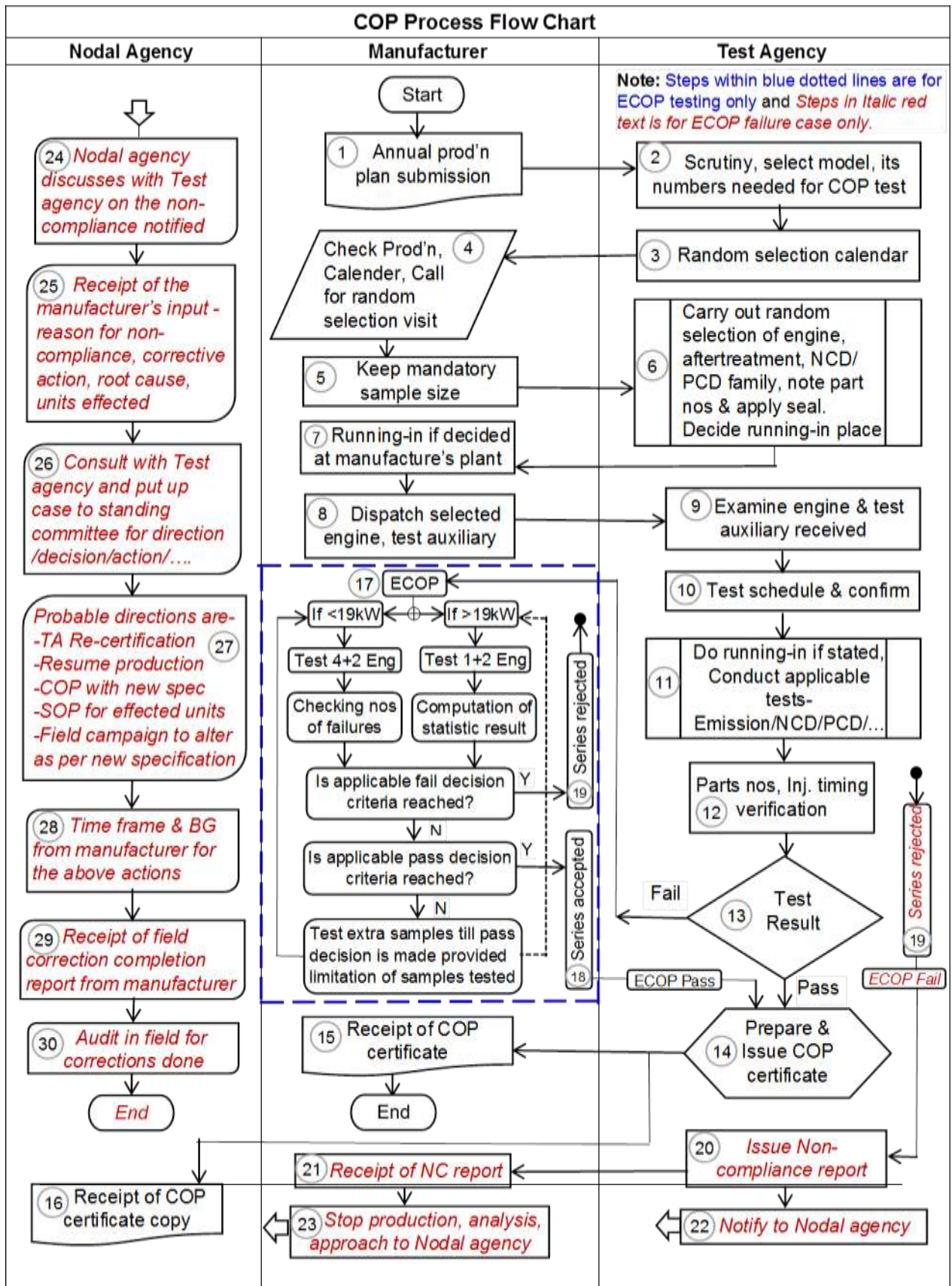

Following are the logical steps for the COP process flow chart described in brief stepwise-
 COP cycle shall end with either -

- I. COP compliance with regular sample testing (Steps 1-16)
- II. COP compliance with extended samples testing (.... Steps 17-18)
- III. COP non-compliance after extended testing (.... Steps 19-30)

CASE I:

1. Manufacturer with valid Type Approval and COP certification submits annual estimated production/import volume data to technical agency involved in the format provided within two months of start of new COP-year.
2. Technical agency, based on the production/import volumes, communicates to manufacturer, the engine type chosen and the number of samples needed for COP compliance test for all engine families of that manufacturer within one month of submission of above production volume data;
3. Technical agency also communicates to the manufacturer plan for COP engine random selection based on manufacture's input above;
4. Manufacturer coordinates adhering to technical agency provided or negotiated plan and coordinates for engine random selection at manufacturing plants/warehouses/sales points for imported engines as the case may be.
5. At the point of selection as mentioned in Sr 4, manufacturer provides with minimum required sample size for random selection;
6. Technical agency representative carries out random selection and does note emission critical component part and serial numbers. Provides with appropriate seal for avoiding tampering of assembly parameters further;
 Technical agency representative randomly selects after treatment system if applicable;
 Technical agency representative can also carry out random selection of an engine if from chosen representative engine family for NCD, PCD compliance utilizing the same pool of engines offered;
7. Decision, if running-in is carried out at manufacturer's location or technical agency location;
 If running-in is agreed to be carried out at manufacture's facility, running-in shall be started in presence of technical agency representative.
8. Engine along with arranged after treatment shall be transported to technical agency test location;
9. Upon receipt of engine along with auxiliaries, technical agency examines the adaptability in test cell, make necessary modification in exhaust line, mounts, etc, if required.
10. Technical agency communicates the test schedule to manufacture for his witness
11. Technical agency carries out engine qualification and emissions test per applicable procedure and shares results with manufacturer;
12. Technical agency carries out critical component type/part numbers, injection timing verification and match with type approved document, in case any change noted, manufacturer to provide the declaration in this regard, till time COP certificate will be on hold.
13. Review of test result & decision on compliance;
14. If COP compliance is obtained, Technical agency prepared the compliance certificate within 4 weeks from the date of testing. Engine & after treatment, test auxiliary is returned to the manufacturer;
15. Technical agency issue compliance certificate to manufacturer
16. Technical agency forwards a copy of compliance certificate to Nodal agency

CASE II:

17. **ECOP:** If non-compliance observed after testing (at Stage No 13), process begins from extended random selection of engine(s) as per preferred options prescribed in clause 5.3.20.
- **ECOP > 19KW (Statistics is on the basis of failed emission values)**
 - 17.1 Initially test 2 more new engines
 - 17.2 Computation of the test statistic result of 3 engines (1-originally tested + 2 new)
 - a) According to the appropriate clause does the test statistic result agree with the criteria for failing the series
 - b) According to the appropriate clause does the test statistic result agree with the criteria for passing the series
 - 17.3 If, answers of a & b are NO, then; continue the testing on additional samples till pass decision is made provided limitation of samples tested as applicable (10 numbers maximum)
 - **ECOP < 19KW (Statistics is on the basis of numbers of failed engine)**
 - 17.4 For establishing the compliance minimum 4 samples are mandatory to be tested and all 4 samples should pass.
 - 17.5 If some samples failed, the additional new more samples, are required to be tested, the numbers depend on the number of samples failed earlier,
 - 17.6 Initially test 2 more new engines
 - 17.7 In the cumulative samples (4-originally tested + 2 new), note the numbers of failed samples
 - c) According to the appropriate clause does the number of failed samples agree with the criteria for failing the series
 - d) According to the appropriate clause does the number of failed samples agree with the criteria for passing the series
 - 17.8 If, answers of a & b are NO, then; continue the testing on additional samples till pass decision is made provided limitation of samples tested as applicable (30 numbers)
18. If during testing if the pass decision criteria is reached, the series is deemed to be compliance and COP certificate is issued (then continue from Stage14-16)

CASE III:

19. If during testing if the fail decision criteria is reached, the series is deemed to be non-compliance;
Or if Manufacturer opts to declare non-compliance without availing total number of samples allowed to be tested, the series is deemed to be non-compliance
20. Technical agency prepares the COP failure report
21. Technical agency issue COP failure report to manufacturer
22. Technical agency informs nodal agency about COP non-compliance of said engine family
23. Manufacturer stops production or import of the said non-compliant engine family;
Manufacturer informs nodal agency about non-conformity, stoppage of production and dispatch and their plan for failure investigation within 4 weeks of receipt of COP verification report or COP failure intimation
24. Nodal agency discusses with test agency in details on the non-compliance notified.
25. Nodal agency replies to the manufacturer about their inputs on timelines by which compliance shall be obtained as well as failure root cause and corrective action plan submission. Nodal agency also informs about any financial penalty or assurance required from the manufacturer;
Manufacturer submits root cause analysis and corrective action plans to nodal agency in consultation with technical agency;

26. Nodal agency in consultation with technical agency reviews manufacture's submissions and decides if such case shall be put forth for standing committee review and guidance if found necessary depending upon the severity of the failure.

If decided to represent at standing committee, nodal agency brings this issue to standing committee and allows manufacture to represent their submissions. If standing committee agrees / approves manufacturer's submission and plan, then;

27. Nodal Agency can also decide on their own & shall take following decision:

27.1 Gives written permission to technical agency to proceed with re-verification of COP with improvements implemented by manufacturer and also type approval re-certification as the case may be.

27.2 Manufacturer offers engine sample and technical documentation to technical agency and complies with COP;

27.3 Technical agency issues compliance certificate or type approval certificate if newly approved as an option;

27.4 Manufacture begins production after obtaining new Type Approval or COP compliance certificate;

27.5 Manufacturer completes corrective actions on engines dispatched during period of COP and COP failure date;

28. Manufacturer complies with 'financial assurance related' documents asked by Nodal Agency;

29. Manufacturer submits corrective action / campaign report with adequate evidences to Nodal Agency

30. Nodal Agency with help from Technical agency audits compliance in field for corrections done and issues closure letter to manufacturer;

End

ANNEXURE – 1

Appendix – A.1

Templates for information folder and information document

1. Information folder

The information folder referred to in clause 4 of this Regulation shall contain the following:

1.1. A list of contents;

- 1.1.1. Approval copy from Nodal Agency with regard to Appendix 1
- 1.2. Manufacturer's declaration on adherence to all requirements of this Regulation in accordance with the template set out in this Appendix
- 1.3. Manufacturer's statement on the compliance of the engine type or engine family with the exhaust emission limits set out in clause 3.1 of this Regulation with regard to specified liquid fuels, fuel mixtures or fuel emulsions other than those set out in Appendix 11 of Annexure 7
- 1.4. For electronically controlled engines of categories Genset, complying with the emission limits set out in Clause 3.1 to this Regulation and using electronic control to determine both the quantity and timing of injecting fuel or using electronic control to activate, de-activate or modulate the emission control system used to reduce NO_x, a complete overview of the emission control strategy, including the base emission control strategy and the means by which every auxiliary control strategy directly or indirectly controls the output variables;
 - 1.4.1. Additional confidential information as set out in Appendix A.2 shall be made available, only for the technical service performing the tests and not included in the information folder;
- 1.5. Where applicable, a full description of the functional operational characteristics of the NO_x control measures and inducement system as referred to in Annex 9 to this Regulation;
 - 1.5.1. Where applicable, a copy of the demonstration reports set out in paragraphs A.1.10.5. and A.1.13.4. of Appendix A.1 of Annexure 8;
 - 1.5.2. Where applicable, a description of the connection for, and method to read, the records set out at paragraph A.1.5.2.1.1. (e) of Appendix A.1 of Annexure 8;
 - 1.5.3. Where the engine type or engine family is member of a NCD engine family, a justification of its membership together with the information requested in paragraph 1.5., 1.5.1. and 1.5.2. on the NCD engine family may be supplied alternatively, upon agreement of the Type Approval Authority;
- 1.6. Where applicable, a full description of the functional operational characteristics of the particulate control measures as referred to in Annexure 8 to this Regulation;
 - 1.6.1. Where applicable, a copy of the demonstration report set out in Appendix A.2 of Annexure 8;
 - 1.6.2. Where applicable, a description of the connection for, and method to read, the records set out at paragraph A.2.5.2. of Appendix A.2 of Annexure 8;
 - 1.6.3. Where the engine type or engine family is a member of a PCD engine family, a justification of its membership together with the information requested in paragraph 1.6., 1.6.1. and 1.6.2. on the PCD engine family may be supplied alternatively, upon agreement of the Type Approval Authority;
- 1.7. Manufacturer's declaration, and supporting test reports or data, on deterioration factors as referred to in clause 3.2.5 of Appendix 6 of Annexure 7 of this Regulation;
 - 1.7.1. Where the engine type or engine family is a member of an engine after-treatment system family, a justification of its membership together with the information requested in paragraph 1.7 on the

- after-treatment system family may be supplied alternatively, upon agreement of the Type Approval Authority;
- 1.8. Where applicable, the manufacturer's declaration, and supporting test reports or data, of the infrequent regeneration adjustment factors referred to in Annex 4 to this Regulation;
 - 1.8.1. Where the engine type or engine family is a member of an engine-after-treatment system family, a justification of its membership together with the information requested in paragraph 1.8 on the engine-after-treatment system family may be supplied alternatively, upon agreement of the Type Approval Authority;
 - 1.9. Manufacturer's declaration and supporting data demonstrating that the emission control strategies fitted are designed in such a way as to prevent tampering to the extent possible, as referred to in Appendix 3 of Annexure 8 of this Regulation.
 - 1.9.1. For engine types and engine families that use an Electronic Control Unit (ECU) as part of the emission control system the information shall include a description of the provisions taken to prevent tampering with and modification of the ECU including the facility for updating using a manufacturer approved programme or calibration;
 - 1.9.2. For engine types and engine families that use mechanical devices as part of the emission control system the information shall include a description of the provisions taken to prevent tampering with and modification of the adjustable parameters of the emission control system. This shall include the tamper resistant components such as carburettor limiter caps or sealing of carburettor screws or special screws not adjustable by user;
 - 1.9.3. In order to place engines from different engine families into the same tamper prevention engine family the manufacturer shall provide confirmation to the Type Approval Authority that the measures used to prevent tampering are similar.
 - 1.10. A description of overall quality-assurance management systems for conformity of production in accordance to clause 5 of this Regulation;
 - 1.11. A list of scheduled emission-related maintenance requirements and the period at which each should occur including any scheduled exchange of critical emission-related components;
 - 1.12. The completed information document as set out in clause 2 of this Annex;
 - 1.12.1. Where the particulars appearing in the information document for an engine approval have changed, the manufacturer shall submit revised pages to the approval authority showing clearly the nature of the change(s) and the date of re-issue;
 - 1.13. All relevant data, drawings, photographs and other information as required in the information document;

2. Information document

The information document shall have a reference number issued by the applicant.

2.1. All information documents shall contain the following:

2.1.1. the general information set out in Part A of Appendix 3;

2.1.2. the information set out in Part B of Appendix 3, to identify the common design parameters of all engine types within an engine family or applicable to the engine type where not part of an engine family, intended for type approval;

2.1.3. the information set out in Part C of Appendix 3 following the format of the matrix set out in clause 2.1.3.1 to identify the items applicable to the parent engine or engine type and the engine types within the engine family, if applicable:

2.1.3.1. Engine type or engine family matrix with example data

Item Number	Item Description	Parent engine/ engine type	Engine types within the engine family (if applicable)			
			type 2	type 3	type ...	type n
3.1	Engine Identification					
3.1.1	Engine type designation	A01	A02	A03	A04	A05
3.2	Performance Parameters					
3.2.1	Declared rated speed(s) (rpm):	2200	2200	2000	1800	1800
3.10	Miscellaneous devices: Yes/No					
3.10.1	Exhaust gas recirculation (EGR)					
3.10.1.1	Characteristics (cooled/uncooled, high pressure/low pressure, etc.):					
...				

2.1.3.2. Reserved

2.1.3.3. In the case of constant speed engines with multiple rated speeds an additional set column(s) of data for each speed shall be recorded in paragraph 3.2 (Performance Parameters).

2.2. Explanatory notes on creation of information document:

2.2.1. Upon agreement of the approval authority, the information in paragraph 2.1.2 and 2.1.3 may be presented in an alternative format;

2.2.2. Each engine type or the parent engine in the matrix set out in paragraph 2.1.3.1 shall be identified in accordance with the engine family designation and engine type designation set out in paragraph 2.3.

2.2.3. Only those paragraphs of this Annex relevant for the particular engine family, engine types within

the engine family or engine type shall be listed; in any case, the list shall adhere to the proposed numbering system,

- 2.2.4. Where several options separated by forward slash are given for an entry, the unused options shall be struck out, or only the used option(s) shall be shown;
 - 2.2.5. When the same value for or description of a certain engine characteristic applies for several or all members of an engine family the corresponding cells may be merged.
 - 2.2.6. Where a picture, diagram or detailed information is required, a reference to an appendix may be given;
 - 2.2.7. Where a 'type' of a component is requested, the information supplied shall uniquely identify the component; this may be a list of characteristics, a manufacturers' name and part or drawing number, a drawing, or a combination of the aforementioned or other methods that achieves the same result.
- 2.3. Engine type designation and engine family designation
- 2.3.1. Engine family designation shall be as per ISO 8178-7 guidelines; however, engine type designation is at the choice of manufacturer.
 - 2.3.2. The manufacturer shall not use the same engine family designation to identify more than one engine family

Appendix – A.2

Confidential information on emission control strategy

A 2.0 Confidential Information on emission control technology

A.2.1. This Appendix shall apply to electronically controlled engines, which use electronic control to determine both the quantity and timing of injecting fuel.

A.2.2. Additional information shall be presented to the test agency but not annexed to the application for type approval. This information shall include all the parameters modified by any auxiliary emission control strategy and the boundary conditions under which this strategy operates and in particular:

- (a) a description of the control logic, of timing strategies and switch points, during all modes of operation for the fuel and other essential systems, resulting in effective emission control (such as exhaust gas recirculation (EGR) or reagent dosing);
- (b) a justification for the use of any auxiliary emission control strategy applied to the engine, accompanied by material and test data, demonstrating the effect on exhaust emissions. This justification may be based on test data, sound engineering analysis, or a combination of both;
- (c) a detailed description of algorithms or sensors (where applicable) used for identifying, analysing, or diagnosing incorrect operation of the NO_x control system;
- (d) a detailed description of algorithms or sensors (where applicable) used for identifying, analysing, or diagnosing incorrect operation of the particulate control system.

A.2.3. The additional information required in paragraph A.2.2 shall be treated as strictly confidential. It shall be retained by the manufacturer and made available for inspection by the Type Approval Authority at the time of type approval or upon request at any time during the validity of the type approval. In this case, the Type Approval Authority shall treat this information as confidential and shall not disclose it to other parties.

Appendix – A.3

Template for submission of engine technical specification

PART A

1. GENERAL INFORMATION

- 1.1. Make (trade name(s) of manufacturer):
- 1.2. Commercial /Brand Name name(s) (if applicable):
- 1.3. Company name and address of manufacturer:
- 1.4. Name and address of manufacturer's authorised representative (if any):
- 1.5. Name(s) and address(es) of assembly/manufacture plant(s):
- 1.6. Engine type designation/engine family designation/FT:
- 1.7. Category Constant speed or variable speed:
- 1.8. Reserved
- 1.9. Reserved
- 1.10. Reserved
- 1.11. Rated Power
- 1.12. Test cycle: D2 5-Mode Steady State cycle discrete-mode type / RMC type
C1 8-Mode Steady State discrete-mode type / RMC type
5-mode variable speed cycle
- 1.13. Reserved
- 1.14. Restrictions on use (if applicable):

PART B

2. COMMON DESIGN PARAMETERS OF ENGINE FAMILY (1)

- 2.1. Combustion Cycle: four stroke cycle/two stroke cycle/other (specify):
- 2.2. Ignition Type: Compression ignition:
- 2.3. Configuration of the cylinders:
 - 2.3.1. Position of the cylinders in the block: Single/V/in-line/opposed/radial/ other(specify):
 - 2.3.2. Bore centre to centre dimension (mm):
- 2.4. Combustion chamber type/design
 - 2.4.1. Open chamber/divided chamber/other(specify):
 - 2.4.2. Valve and porting configuration:
 - 2.4.3. Number of valves per cylinder:
- 2.5. Range of swept volume per cylinder (cm³):
- 2.6. Main Cooling medium: Air/Water/Oil:

- 2.7. Method of air aspiration: naturally aspirated/pressure charged/pressure charged with charge cooler:
- 2.8. Fuel:
 - 2.8.1. Fuel Type: Diesel/ Ethanol for dedicated compression ignition engines (ED95) (Natural gas/Biomethane) / LPG / Any other alternate fuel as specified in this document
 - 2.8.1.1. Reserved.
 - 2.8.2. Fuelling arrangement: Dual-fuel type 1A/Dual-fuel type 1B/Dual-fuel type 2A/Dual-fuel type 2B/Dual-fuel type
 - 2.8.3. List of additional fuels, fuel mixtures or emulsions compatible with use by the engine declared by the manufacturer in accordance with Appendix 3 to paragraph 5 of this Regulation (provide reference to recognised standard or specification):
 - 2.8.4. Lubricant added to fuel: Yes/No
 - 2.8.5. Fuel supply type: Pump (high pressure) line and injector/in-line pump or distributor pump/Unit injector/ Common rail.
- 2.9. Engine management systems: mechanical/electronic control strategy
- 2.10. Miscellaneous devices: Yes/No (if yes provide a schematic diagram of the location and order of the devices)
 - 2.10.1. Exhaust gas recirculation (EGR): Yes/No (if yes, complete section 3.10.1 and provide a schematic diagram of the location and order of the devices)
 - 2.10.2. Water injection: Yes/No (if yes, complete section 3.10.2 and provide a schematic diagram of the location and order of the devices)
 - 2.10.3. **Air injection: Yes/No (if yes, complete section 3.10.3 and provide a schematic diagram of the location and order of the devices)**
 - 2.10.4. Others: Yes/No (if yes specify, complete section 3.10.4 and provide a schematic diagram of the location and order of the devices):
- 2.11. Exhaust after-treatment system: Yes/No (if yes provide a schematic diagram of the location and order of the devices)
 - 2.11.1. Oxidation catalyst: Yes/No
(if yes, complete section 3.11.2)
 - 2.11.2. De NO_x system with selective reduction of NO_x (addition of reducing agent): Yes/No
(if yes, complete section 3.11.3)
 - 2.11.3. Other De NO_x systems: Yes/No
(if yes, complete section 3.11.3)
 - 2.11.4. Reserved
 - 2.11.5. Particulate after-treatment system with passive regeneration: Yes/No
(if yes, complete section 3.11.4)
 - 2.11.5.1. Wall-flow/non-wall-flow
 - 2.11.6. Particulate after-treatment system with active regeneration: Yes/No
(if yes, complete section 3.11.4)
 - 2.11.6.1. Wall-flow/non-wall-flow

- 2.11.7. Other particulate after-treatment systems: Yes/No
(if yes, complete section 3.11.4)
- 2.11.8. Other after-treatment devices (specify):
(if yes, complete section 3.11.5)
- 2.11.9. Other devices or features that have a strong influence on emissions Yes/No
(specify):
(if yes, complete section 3.11.7)

PART C

Item Number	Item Description	Parent engine/ engine type	Engine types within the engine family (if applicable)				Explanatory notes (not included in document)
			type 2	type 3	...	type n	
3.1.	Engine Identification						
3.1.1.	Engine type designation						
3.1.2.	Engine type designation shown on engine marking: yes/no						
3.1.3.	Location of the statutory marking:						
3.1.4.	Method of attachment of the statutory marking:						
3.1.5.	Drawings of the location of the engine identification number (complete example with dimensions):						
3.2.	Performance Parameters						
3.2.1.	Declared rated speed(s) (rpm):						
3.2.1.1.	Declared rated gross power (kW):						
3.2.1.2.	Fuel delivery/stroke (mm ³) for diesel engine, fuel flow (g/h) for other engines, at rated gross power						
3.2.6.	Idle speed (rpm)						
3.2.7.	No load speed (rpm):						
3.2.8	Overload load speed (rpm): %Overload Power load %: eg.10%						
3.3.	Run-in procedure						Optional at choice of manufacturer
3.3.1.	Run-in time:						
3.3.2.	Run-in cycle:						
3.4.	Engine test						
3.4.1.	Specific fixture required: Yes/No						For NRSh only
3.4.1.1	Description, including photographs and/or drawings, of the system for mounting the engine on the test bench including the power transmission shaft for connection to the dynamometer:						
3.4.2.	Exhaust mixing chamber permitted by manufacturer: Yes/No						For NRSh only

Item Number	Item Description	Parent engine/ engine type	Engine types within the engine family (if applicable)				Explanatory notes (not included in document)
			type 2	type 3	type ...	type n	
3.4.2.1.	Exhaust mixing chamber description, photograph and/or drawing:						If applicable
3.4.3.	Pre-conditioning for: Steady-state operation						
3.5.	Lubrication system						
3.5.1.	Lubricant temperature						If applicable
3.5.1.1.	Minimum (°C):						
3.5.1.2.	Maximum (°C):						
3.6.	Combustion Cylinder						
3.6.1.	Bore(mm):						
3.6.2.	Stroke(mm):						
3.6.3.	Number of cylinders:						
3.6.4.	Engine total swept volume (cm ³):						
3.6.5.	Swept volume per cylinder as % of parent engine:						If engine family
3.6.6.	Volumetric compression ratio:						Specify tolerance
3.6.7.	Combustion system description:						
3.6.8.	Drawings of combustion chamber and piston crown:						
3.6.9.	Minimum cross-sectional area of inlet and outlet ports (mm ²):						
3.6.10.	Valve timing						
3.6.10.1.	Maximum lift and angles of opening and closing in relation to dead centre or equivalent data:						
3.6.10.2.	Reference and/or setting range:						
3.6.10.3.	Variable valve timing system: Yes/No						If applicable and where intake and/or exhaust
3.6.10.3.1.	Type: continuous/(on/off)						
3.6.10.3.2.	Cam phase shift angle:						
3.6.11.	Porting configuration						2-stroke only, if applicable
3.6.11.1.	Position, size and number:						
3.7.	Cooling system						Complete relevant section
3.7.1.	Liquid cooling						
3.7.1.1.	Nature of liquid:						
3.7.1.2.	Circulating pumps: Yes/No						
3.7.1.2.1.	type(s):						
3.7.1.2.2.	Drive ratio(s):						If applicable
3.7.1.3.	Minimum coolant temperature at outlet (°C):						

Item Number	Item Description	Parent engine/ engine type	Engine types within the engine family (if applicable)				Explanatory notes (not included in document)
			type 2	type 3	type ...	type n	
3.7.1.4.	Maximum coolant temperature at outlet (°C):						
3.8.	Aspiration						
3.8.1.	Maximum allowable intake depression at rated engine speed and at 100% load (kPa)						
3.8.1.1.	With clean air cleaner:						
3.8.1.2.	With dirty air cleaner:						
3.8.1.3.	Location, of measurement:						
3.8.2.	Pressure charger(s): Yes/No						
3.8.2.1.	Type(s):						
3.8.2.2.	Description and schematic diagram of the system (e.g. maximum charge pressure,-waste gate, VGT, Twin turbo, etc.):						
3.8.3.	Charge air cooler: Yes/No						
3.8.3.1.	Type: air-air/air-water/other(specify)						
3.8.3.2.	Maximum charge air cooler outlet temperature at rated speed and 100% load (°C):						
3.8.3.3.	Maximum allowable pressure drop across charge cooler at rated engine speed and at 100% load (kPa):						
3.8.4.	Intake throttle valve: Yes/No						
3.8.5.	Device for recycling crankcase gases: Yes/No						
3.8.5.1.	If yes, description and drawings:						
3.8.5.2.	If no, compliance with paragraph 5.7. of this Regulation: Yes/No						
3.9.	Exhaust system						
3.9.1.	Description of the exhaust system (with drawings, photos and/or part numbers as required):						
3.9.2.	Maximum exhaust temperature (°C):						
3.9.3.	Maximum permissible exhaust backpressure at rated engine speed and at 100% load (kPa):						
	Maximum permissible exhaust backpressure at at each mode of test cycle (kPa): (This data is required for the engines with EGR) 100% Load: 75% Load: 50% Load: 25% Load:						

Item Number	Item Description	Parent engine/ engine type	Engine types within the engine family (if applicable)				Explanatory notes (not included in document)
			type 2	type 3	...	type n	
	10% Load:						
3.9.3.1.	Location of measurement:						
3.9.4.	Exhaust backpressure at loading level specified by manufacturer for variable restriction after-treatment at start of test (kPa):						
3.9.4.1.	Location and speed/load conditions:						
3.9.5.	Exhaust throttle valve: Yes/No						
3.10.	Miscellaneous devices: Yes/No						
3.10.1.	Exhaust gas recirculation (EGR)						
3.10.1.1.	Characteristics: cooled/uncooled, high pressure/low pressure/other (specify):						
3.10.2.	Water injection						
3.10.2.1.	Operation principle:						
3.10.3.	Air injection						
3.10.3.1.	Operation principle						
3.10.4.	Others						
3.10.4.1.	Type(s)						
3.11.	Exhaust after-treatment system						
3.11.1.	Location						
3.11.1.1.	Place(s) and maximum/minimum distance(s) from engine to first after-treatment device:						
3.11.1.2.	Maximum temperature drop from exhaust or turbine outlet to first after-treatment device (°C) if stated:						
3.11.1.2.1.	Test conditions for measurement:						
3.11.1.3.	Minimum temperature at inlet to first after-treatment device, (°C) if stated:						
3.11.1.3.1.	Test conditions for measurement:						
3.11.2.	Oxidation catalyst						
3.11.2.1.	Number of catalytic converters and elements:						
3.11.2.2.	Dimensions and volume of the catalytic converter(s):						<i>Or drawing</i>
3.11.2.3.	Total charge of precious metals (g):						
3.11.2.4.	Relative concentration of each compound (%):						
3.11.2.5.	Substrate (structure and material):						
3.11.2.6.	Cell density:						
3.11.2.7.	Type of casing for the catalytic converter(s):						
3.11.3.	Catalytic exhaust after-treatment system for NO _x or three-way catalyst						

Item Number	Item Description	Parent engine/ engine type	Engine types within the engine family (if applicable)				Explanatory notes (not included in document)
			type 2	type 3	type ...	type n	
3.11.3.1.	Type:						
3.11.3.2.	Number of catalytic converters and elements:						
3.11.3.3.	Type of catalytic action :						
3.11.3.4.	Dimensions and volume of the catalytic converter(s):						<i>Or drawing</i>
3.11.3.5.	Total charge of precious metals (g):						
3.11.3.6.	Relative concentration of each compound (%):						
3.11.3.7.	Substrate (structure and material):						
3.11.3.8.	Cell density:						
3.11.3.9.	Type of casing for the catalytic converter(s):						
3.11.3.10.	Method of regeneration:						If applicable
3.11.3.10.1.	Infrequent regeneration: Yes/No:						If yes, complete section 3.11.6.
3.11.3.11.	Normal operating temperature range (°C):						
3.11.3.12.	Consumable reagent: Yes/No						
3.11.3.12.1.	Type and concentration of reagent needed for catalytic action:						
3.11.3.12.2.	Lowest concentration of the active ingredient present in the reagent that does not activate warning system (CD _{min}) (%vol):						
3.11.3.12.3.	Normal operational temperature range of reagent:						
3.11.3.12.4.	International standard:						If applicable
3.11.3.13.	NO _x sensor(s): Yes/No						
3.11.3.13.1.	Type:						
3.11.3.13.2.	Location(s)						
3.11.3.14.	Oxygen sensor(s): Yes/No						
3.11.3.14.1.	Type:						
3.11.3.14.2.	Location(s):						
3.11.4.	Particulate after-treatment system						
3.11.4.1.	Type of filtration: wall-flow/ non-wall-flow/other (specify)						
3.11.4.2.	Type:						
3.11.4.3.	Dimensions and capacity of the particulate after-treatment system:						<i>Or drawing</i>
3.11.4.4.	Location place(s) and maximum and minimum distance(s) from engine:						
3.11.4.5.	Method or system of regeneration, description and/or drawing:						

Item Number	Item Description	Parent engine/ engine type	Engine types within the engine family (if applicable)				Explanatory notes (not included in document)
			type 2	type 3	type ...	type n	
3.11.4.5.1.	Infrequent regeneration: Yes/No						If yes, complete section 3.11.6.
3.11.4.5.2.	Minimum exhaust gas temperature for initiating regeneration procedure (°C):						
3.11.4.6.	Catalytic coating: Yes/No						
3.11.4.6.1.	Type of catalytic action:						
3.11.4.7.	Fuel borne catalyst (FBC): Yes/No						
3.11.4.8.	Normal operating temperature range (°C):						
3.11.4.9.	Normal operating pressure range (kPa)						
3.11.4.10.	Storage capacity soot/ash (g):						
3.11.4.11.	Oxygen sensor(s): Yes/No						
3.11.4.11.1.	Type:						
3.11.4.11.2.	Location(s):						
3.11.5.	Other after-treatment devices						
3.11.5.1.	Description and operation:						
3.11.6.	Infrequent Regeneration						
3.11.6.1.	Number of cycles with regeneration						
3.11.6.2.	Number of cycles without regeneration						
3.11.7.	Other devices or features						
3.11.7.1.	Type(s)						
3.12.	Fuel feed for liquid-fuelled CI or, where applicable, dual-fuel engines						
3.12.1.	Feed pump						
3.12.1.1.	Pressure (kPa) or characteristic diagram:						
3.12.2.	Injection system						
3.12.2.1.	Fuel Pump						
3.12.2.1.1.	Type(s):						
3.12.2.1.2.	Rated pump speed (rpm):						
3.12.2.1.3.	mm ³ per stroke or cycle at full injection at rated pump speed:						Specify tolerance
3.12.2.1.4.	Reserved						
3.12.2.1.5.	Reserved						Specify tolerance
3.12.2.1.6.	Characteristic diagram:						As alternative to entries 3.12.2.1.1. to 3.12.2.1.5.
3.12.2.1.7.	Method used: on engine/on pump bench						
3.12.2.2.	Injection timing						For Mechanical engines- static injection timing values BTDC

Item Number	Item Description	Parent engine/ engine type	Engine types within the engine family (if applicable)				Explanatory notes (not included in document)
			type 2	type 3	...	type n	
							For Electronic engines- calibration/software part number/ID number of the calibration map
3.12.2.2.1.	Injection timing curve:						Specify tolerance, if applicable
3.12.2.2.2.	Static Timing:						Specify tolerance
3.12.2.3.	Injection piping						
3.12.2.3.1.	Length(s) (mm):						
3.12.2.3.2.	Internal diameter (mm):						
3.12.2.4.	Common rail: Yes/No						
3.12.2.4.1.	Type:						
3.12.3.	Injector(s)						
3.12.3.1.	Type(s):						
3.12.3.2.	Opening pressure (kPa):						Specify tolerance
3.12.4.	ECU: Yes/No						
3.12.4.1.	Type(s):						
3.12.4.2.	Software calibration number(s):						
3.12.4.3.	Communication standard(s) for access to data stream information: ISO 27145 with ISO 15765-4 (CAN-based)/ISO 27145 with ISO 13400 (TCP/IP-based)/SAE J1939-73						
3.12.5.	Governor						
3.12.5.1.	Type(s):						
3.12.5.2.	Speed at which cut-off starts under full load:						Specify range, if applicable
3.12.5.3.	Maximum no-load speed:						Specify range, if applicable
3.12.5.4.	Idle speed:						Specify range, if applicable
3.12.6.	Cold-start system: Yes/No						
3.12.6.1.	Type(s):						
3.12.6.2.	Description:						
3.12.7.	Fuel temperature at the inlet to the fuel injection pump						
3.12.7.1.	Minimum (°C):						
3.12.7.2.	Maximum (°C):						
3.13.	Reserved						

For dual fuel application, please refer below additional table:

Item Number	Item Description	Parent engine/ engine type	Engine types within the engine family (if applicable)				Explanatory notes (not included in document)
			type 1	Type 2	Type 3	Type n	
4.1	Details of Kit Manufacturer / Supplier / Installer						
4.1.1	Name of the Manufacturer						
4.1.2	Address						
4.1.3	Telephone No. & Fax No.						
4.2	Gas Kit Identification						
4.2.1	Identification No.						
4.2.2	Variants, if any						
4.2.3	Fuel system (Dedicated / Bi-Fuel / Dual Fuel / Dedicated Dual Fuel)						
4.2.4	Type of Dual- fuel system (Type 1A / 1B / 2A / 2B / 3B)						
4.2.5	Fuel (Gas Fuel (Specify Name of fuel)						
4.3	Solenoid Valve / Automatic shutoff valve						
4.3.1	Name of manufacturer						
4.3.2	Model Name / Identification No.						
4.3.3	Type						
4.3.4	Working pressure (kg/cm ²)						
4.3.5	Max test pressure (kg/cm ²)						
4.3.6	Approval reference (Test Report / Approval Number)						
4.4	High Pressure Regulator						
4.4.1	Name of manufacturer						
4.4.2	Model name / Identification No.						
4.4.3	Type						
4.4.4	Inlet pressure (kg/cm ²)						
4.4.5	Outlet pressure (kg/cm ²)						
4.4.6	No. of stages						
4.4.7	Approval reference (Test Report / TAC compliance with Date)						
4.5	Low Pressure Regulator						
4.5.1	Name of manufacturer						
4.5.2	Model name / Identification No.						
4.5.3	Type						
4.5.4	Inlet pressure (kg/cm ²)						
4.5.5	Outlet pressure (kg/cm ²)						
4.5.6	No. of stages						
4.5.7	Approval reference (Test Report / TAC compliance with Date)						
4.6	Zero Pressure Regulator						
4.6.1	Name of manufacturer						
4.6.2	Model name / Identification No.						
4.6.3	Type						
4.6.4	Inlet pressure (kg/cm ²)						
4.6.5	Outlet pressure (kg/cm ²)						

Item Number	Item Description	Parent engine/ engine type	Engine types within the engine family (if applicable)				Explanatory notes (not included in document)
			type 1	Type 2	Type 3	Type n	
4.6.6	Approval reference (Test Report / TAC compliance with Date)						
4.7	Vaporizer / Heat exchanger (for LNG)						
4.7.1	Name of manufacturer						
4.7.2	Model name / Identification No.						
4.7.3	Type						
4.7.4	Inlet pressure (kg/cm ²)						
4.7.5	Outlet pressure (kg/cm ²)						
4.7.6	Approval reference (Test Report / Approval Number)						
4.8	Filter						
4.8.1	Name of manufacturer						
4.8.2	Model name / Identification No.						
4.8.3	Type						
4.8.4	Inlet pressure (kg/cm ²)						
4.8.5	Outlet pressure (kg/cm ²)						
4.9	High Pressure Tubing						
4.9.1	Name of manufacturer						
4.9.2	Model name / Identification No.						
4.9.3	Type (rigid / flexible)						
4.9.4	Working pressure (kg/cm ²)						
4.9.5	Max. test pressure (kg/cm ²)						
4.9.6	Outer diameter / Inner Diameter (mm)						
4.9.7	Material						
4.9.8	Approval reference (Test Report / Approval Number)						
4.10	Low Pressure Tubing						
4.10.1	Name of manufacturer						
4.10.2	Model name / Identification No.						
4.10.3	Type						
4.10.4	Working pressure (kg/cm ²)						
4.10.5	Max test pressure (kg/cm ²)						
4.10.6	Outer diameter / Inner Diameter (mm)						
4.10.7	Material						
4.10.8	Approval reference (Test Report / Approval Number)						
4.11	Gas-Air Mixer						
4.11.1	Name of manufacturer						
4.11.2	Model name / Identification No						
4.11.3	Type & drawing						
4.11.4	Venturi Size (mm)						
4.11.5	Approval reference (Test Report / Approval Number)						
4.12	Gas Injector						

Item Number	Item Description	Parent engine/ engine type	Engine types within the engine family (if applicable)				Explanatory notes (not included in document)
			type 1	Type 2	Type 3	Type n	
4.12.1	Name of manufacturer						
4.12.2	Model name / Identification No						
4.12.3	Type & drawing						
4.12.4	Injector flow specs						
4.12.5	Approval reference (Test Report / Approval Number)						
4.13	Wiring Harness						
4.13.1	Name of manufacturer						
4.13.2	Electrical circuit diagram / Detail layout						
4.13.3	Approval reference (Test Report / Approval Number)						
4.14	Interfacing Unit (ECU)						
4.14.1	Name of manufacturer						
4.14.2	Identification No.						
4.14.3	Type						
4.15	Fuel selector switch						
4.15.1	Name of manufacturer						
4.15.2	Model No						
4.15.3	Type						
4.16	Fuel flow actuation mechanism (Mechanical / Electronic)						
4.16.1	Brief description of system (Attach Annexure)						
4.16.2	Schematic layout (Attach Drawing)						
4.16.3	Identification of critical components of Kit, including ECU, Lambda sensor, Pressure sensor, temperature Sensor etc with Make and Identification number (attach Annexure)						
4.17	Brief Description of System Including Dimensional Layout for kit components installation ventilation details etc.						
4.18	Joints and connections						
4.18.1	Name of manufacturer						
4.18.2	Type						
4.18.3	Number of Joints and connections represented on Drawing (Attach Drawing)						
4.19	Current limiting Device (Fuse)						
4.19.1	Name of manufacturer						
4.19.2	Identification No.						
4.19.3	Voltage / current rating						
4.19.4	Type						

Item Number	Item Description	Parent engine/ engine type	Engine types within the engine family (if applicable)				Explanatory notes (not included in document)
			type 1	Type 2	Type 3	Type n	
4.19.5	Approval reference (Test Report / Approval Number)						
4.20	Indicator						
4.20.1	Pressure Indicator						
4.20.2	Name of manufacturer						
4.20.3	Identification No.						
4.20.4	Type						
4.20.5	Temperature Indicator (for LNG)						
4.20.6	Name of manufacturer						
4.20.7	Identification No.						
4.20.8	Type						
4.21	Service shut off valve						
4.21.1	Name of manufacturer						
4.21.2	Identification No.						
4.21.3	Type						
4.22	Compartment/Sub-compartment / Gas tight housing						
4.22.1	Name of manufacturer						
4.22.2	Identification No						
4.22.3	Type						
4.22.4	Material used						
4.22.5	Approval reference (Test Report / Approval Number)						
4.23	Conduit						
4.23.1	Name of manufacturer						
4.23.2	Identification No.						
4.23.3	Inner & outer diameter						
4.23.4	Type						
4.23.5	Approval reference (Test Report / Approval Number)						
4.24	Battery cut off switch (if applicable)						
4.24.1	Name of manufacturer						
4.24.2	Identification No.						
4.24.3	Type						
4.25	Labels - Number and position						
4.26	Any other information						
	* Mention NA wherever not applicable						

Explanatory notes to Appendix 3:

(Footnote markers, footnotes, and explanatory notes not to be stated on the information document)

In the case of combined catalyst and particulate filter both pertinent sections shall be filled.

ANNEXURE – 2

Communication – Type Approval and COP Template to be attached here by Test Agencies

1. General

SECTION I

- 1.1. Make (trade name(s) of manufacturer):
- 1.2. Commercial name(s)/ Brand Name (if applicable):
- 1.3. Company name and address of manufacturer:
- 1.4. Name and address of manufacturer's authorised representative (if any):
- 1.5. Name(s) and address(es) of assembly/manufacture plant(s):
- 1.6. Engine type designation/engine family designation/FT:
- 1.7. Category and sub-category of the engine type/engine family:

SECTION II

1. Technical service responsible for carrying out the test(s):
2. Date(s) of the test report(s):
3. Number(s) of the test report(s):

SECTION III

The undersigned hereby certifies the accuracy of the manufacturer's description in the attached information document of the engine type/engine family ⁽²⁾ described above, for which one or more representative samples, selected by the approval authority, have been submitted as prototypes and that the attached test results apply to the engine type/engine family ⁽²⁾.

1. The engine type/engine family ⁽²⁾ meets/does not meet ⁽²⁾ the requirements laid down in GSR 804(E.) dated 3-Nov-2022 series of amendments.
2. The approval is granted/extended/refused/withdrawn ⁽²⁾

Place:

Date:

Name and signature:

Attachments:

Information folder

Test report(s)

All other documents added by the technical services or by the Type Approval Authority to the information folder in the course of carrying out their functions.

Approval number:

2. Common design parameters of the engine type/engine family

- 2.1. Combustion Cycle: four stroke cycle/two stroke cycle/rotary/other:
- 2.2. Ignition Type: Compression ignition

- 2.3.1. Position of the cylinders in the block: V/in-line/radial/other(describe) ⁽²⁾
- 2.6 Main Cooling medium: Air/Water/Oil ⁽²⁾
- 2.7. Method of air aspiration: naturally aspirated/pressure charged/pressure charged with charge cooler ⁽²⁾
- 2.8.1. Fuel Type(s): Diesel (non-road gas-oil)/Ethanol for dedicated compression ignition engines (ED95)/ Ethanol (E85) / (Natural gas/Biomethane) / Alternate Fuel
- 2.8.1.1. Reserved
- 2.8.2. Fuelling arrangement: Liquid-fuel only /Dual-fuel type 1A/Dual-fuel type 1B/Dual-fuel type 2A/Dual-fuel type 2B/Dual-fuel type 3B
- 2.8.3. List of additional fuels compatible with use by the engine declared by the manufacturer in accordance with paragraph A.3.1.2.3. of Annex 3 to paragraph 5 of this Regulation (provide reference to recognised standard or specification):
- 2.8.4. Lubricant added to fuel: Yes/No ⁽²⁾
- 2.8.5. Fuel supply type: Pump (high pressure) line and injector/in-line pump or distributor pump/Unit injector/ Common rail
- 2.9. Engine management systems: mechanical/electronic control strategy ⁽²⁾
- 2.10. Miscellaneous devices: Yes/No ⁽²⁾
- 2.10.1. Exhaust gas recirculation (EGR): Yes/No ⁽²⁾
- 2.10.2. Water injection: Yes/No ⁽²⁾
- 2.10.3. Air injection: Yes/No ⁽²⁾
- 2.10.4. Others (specify):
- 2.11. Exhaust after-treatment system: Yes/No ⁽²⁾
- 2.11.1. Oxidation catalyst: Yes/No ⁽²⁾
- 2.11.2. De NO_x system with selective reduction of NO_x (addition of reducing agent): Yes/No ⁽²⁾
- 2.11.3. Other De NO_x systems: Yes/No ⁽²⁾
- 2.11.4. Three-way catalyst combining oxidation and NO_x reduction: Yes/No
- 2.11.5. Particulate after-treatment system with passive regeneration: Yes/No
- 2.11.6. Particulate after-treatment system with active regeneration: Yes/No
- 2.11.7. Other particulate after-treatment systems: Yes/No
- 2.11.8. Three-way catalyst combining oxidation and NO_x reduction: Yes/No
- 2.11.9. Other after-treatment devices (specify):
- 2.11.10. Other devices or features that have a strong influence on emissions (specify):

3. Essential characteristics of the engine type(s)

Item Number	Item Description	Parent Engine / Engine type	Engine types within the family (if applicable)		
3.1.1.	Engine Type Designation:				
3.1.2.	Engine type designation shown on engine mark: Yes/No				
3.1.3.	Location of the manufacturer's statutory marking:				
3.2.1.	Declared rated speed (rpm):				
3.2.2.2.	Declared Rated Power (kW)				
3.2.3.2.	Declared Rated torque (Nm):				
3.6.3.	Number of Cylinders:				
3.6.4.	Engine total swept volume (cm ³):				
3.8.5.	Device for recycling crankcase gases: Yes/No				
3.11.3.12.	Consumable reagent: Yes/No				
3.11.3.12.1.	Type and concentration of reagent needed for catalytic action:				
3.11.3.13.	NO _x sensor(s): Yes/No				
3.11.3.14.	Oxygen sensor: Yes/No				
3.11.4.7.	Fuel borne catalyst (FBC): Yes/No				
Conditions to be respected in the installation of the engine on Genset					
3.8.1.1.	Maximum allowable intake depression at rated engine speed and at 100% load (kPa) with clean air cleaner:				
3.8.3.2.	Maximum charge air cooler outlet temperature at rated speed and 100% load (deg. C):				
3.8.3.3.	Maximum allowable pressure drop across charge cooler at rated engine speed and at 100% load (kPa) (if applicable):				
3.9.3.	Maximum permissible exhaust gas back-pressure at rated engine speed and at 100% load (kPa):				

Item Number	Item Description	Parent Engine / Engine type	Engine types within the family (if applicable)		
	Maximum permissible exhaust backpressure at each mode of test cycle (kPa): (This data is required for the engines with EGR) 100% Load: 75% Load: 50% Load: 25% Load: 10% Load:				
3.9.3.1.	Location of measurement:				
3.11.1.2	Maximum temperature drop from exhaust system or turbine outlet to first exhaust after-treatment system (deg. C) if stated:				
3.11.1.2.1.	Test conditions for measurement:				

4. Cycle emission results

Emissions	CO (g/kWh)	HC (g/kWh)	NO _x (g/kWh)	HC+ NO _x (g/kWh)	PM (g/kWh)	SMOKE m ⁻¹	Test Cycle ⁽⁴⁾
DF incorporated adjusted emission result before rounding							
Final rounded certificate result with DF.							

CO₂ result:

(CO₂ g/kWh is only for the documentation purpose & does not have any impact on pass or fail criteria the engine)

Explanatory notes to Annex 2

(Footnote markers, footnotes, and explanatory notes not to be stated on the type-approval certificate)

- (1) Distinguishing number of the contracting party which has granted/extended/refused/withdrawn an approval.
- (2) Strike out the unused options, or only show the used option(s).
- (3) Indicate the applicable option for the category and sub-category in accordance with entry 1.7. of the information document set out in Part A of Appendix 3 to Annex 1.
- (4) Indicate the used test cycle as prescribed in Annexure 7 to this Regulation.

Appendix – A.1 Test Report

A.1.1. General requirements

One test report shall be completed for each test required for the type-approval. Each additional (e.g. a second speed on a constant speed engine) or supplementary test (e.g. another fuel is tested) will require an additional or supplementary test report.

A.1.2. Explanatory notes on creation of a test report

- A.1.2.1. A test report shall contain at least the information set out in paragraph A.1.3.
- A.1.2.2. Notwithstanding paragraph A.1.2.1, only those sections or sub-sections relevant for the particular test and for the particular engine family, engine types within the engine family or engine type tested need to be stated in the test report
- A.1.2.3. The test report may contain more information than that requested in paragraph A.1.2.1 but in any case, shall adhere to the proposed numbering system;
- A.1.2.4. Where several options separated by forward slash are given for an entry, the unused options shall be struck out, or only the used option(s) shall be shown;
- A.1.2.5. Where a 'type' of a component is requested, the information supplied shall uniquely identify the component; this may be a list of characteristics, a manufacturers' name and part or drawing number, a drawing, or a combination of the aforementioned or other methods that achieves the same result.
- A.1.2.6. The test report may be delivered on paper or in an electronic format agreed between the manufacturer, technical service and Type Approval Authority.

A.1.3 Template for the test report

1. General Information

- 1.1. Make(s) (trade name(s) of manufacturer):
- 1.2. Commercial name(s) /Brand Name_(if applicable):
- 1.3. Company name and address of manufacturer:
- 1.4. Name of test agency:
- 1.5. Address of test agency:
- 1.6. Location of test:
- 1.7. Date of test:
- 1.8. Test report number:
- 1.9. Information document reference number (if available):
- 1.10. Test report type: Primary test/additional test/supplementary test

Primary test -standard regular test most likely common for approval.

Additional test - additional test is for in case there are more than one options for performance emission related components, i.e. 2 different make injector, 2 turbo etc.

Supplementary test - supplementary test is for verification/ determination of regeneration strategy or any other

- 1.10.1. Description of the purpose of the test:

2. General engine information (test engine)

- 2.1. Engine type designation/engine family designation/FT:
- 2.2. Engine identification number:
- 2.3. Engine Category and subcategory:

3. Documentation and information Check list (primary test only)

- 3.1. Engine mapping documentation reference:
- 3.2. Deterioration factor determination documentation reference:
- 3.3. Infrequent regeneration factors determination documentation reference, where applicable:
- 3.4. NO_x control diagnostic demonstration documentation reference, where applicable:
- 3.5. Particulate control diagnostic demonstration documentation reference, where applicable:
- 3.6. For engine types and engine families that use an ECU as part of the emission control system anti-tampering declaration documentation reference:
- 3.7. For engine types and engine families that use mechanical devices as part of the emission control system anti- tampering and adjustable parameters declaration and demonstration documentation reference:

4. Reference fuel(s) used for test (complete relevant subparagraph(s))

4.2. Liquid fuel for compression-ignition engines

- 4.2.1. Make:
- 4.2.2. Type:
- 4.2.3. Cetane number:
- 4.2.4. Fame content (%):
- 4.2.5. Density at 15 °C (kg/m³):

4.3. Reserved

4.4. Reserved

4.5. Dual-fuel engine (in addition to relevant sections above)

- 4.5.1. Gas energy ratio on test cycle:

5. Lubricant

- 5.1. Make(s):
- 5.2. Type(s):
- 5.3. SAE viscosity:
- 5.4. Lubricant and fuel are mixed: yes/no
- 5.4.1. Percentage of oil in mixture:

6. Engine Speed

- 6.1. Declared rated speed:
 - 6.1.1. Overload speed:
 - 6.1.2. Idle speed:

- 7. **Engine Power.**
- 8. **Conditions at test**
 - 8.1. f_a within range 0.93 to 1.07: Yes/No
 - 8.1.1. If f_a is not within specified range state altitude of test facility and dry atmospheric pressure:
 - 8.2. Applicable intake air temperature range: 20 to 30 °C (up 560kW/ 20 to 35 °C (greater than 560 kW only)
- 9. **Test result**
 - 9.1. 5-mode cycle Emissions results
 - 9.2. Deterioration Factor (DF): calculated/assigned
 - 9.2.1. DF values and the cycle weighted emissions results to be stated in Table 6:
 Note: In the event that a discrete mode 5-mode cycle is run where the K_{ru} or K_{rd} factors have been established for individual modes then a table showing each mode and the applied K_{ru} or K_{rd} should replace the shown table.

**Table 6
5-mode cycle DF values and weighted emissions results**

DF mult/add	CO	HC	NO _x	HC+ NO _x	PM	Smoke
Emissions	CO (g/kWh)	HC (g/kWh)	NO _x (g/kWh)	HC+ NO _x (g/kWh)	PM (g/kWh)	Smoke m ⁻¹
Test result with/without regeneration						
k_{ru}/k_{rd} mult/add						NA
test result with infrequent regeneration adjustment factors (IRAFs) before rounding						NA
Final rounded test result with DF						

- 9.3 Cycle weighted CO₂ (g/kWh):
- 9.3.1 Cycle average NH₃ (ppm):
- 9.4. Additional control area test points (if applicable) to be stated in Table 7:

Table 7

Additional control area test points

Emissions at test point	Engine Speed	Load (%)	CO (g/kWh)	HC (g/kWh)	NO _x (g/kWh)	HC+NO _x (g/kWh)	PM (g/kWh)	Smoke m ⁻¹
Test result 1								
Test result 2								

9.5. Sampling systems used for the 5-mode emission test:

9.5.1. Gaseous emissions:

9.5.2. PM:

9.5.2.1. Method: single/multiple filter

10. Final emissions results

10.1 Cycle emissions results to be stated in Table 8.

Table 8**Final emissions results**

Emissions	CO (g/kWh)	HC (g/kWh)	NO _x (g/kWh)	HC+ NO _x (g/kWh)	PM (g/kWh)	Smoke m ⁻¹	Test Cycle ⁽¹⁾
5-mode cycle final rounded test result with DF.							

10.2 CO₂ result:

Explanatory notes to the test report template

(Footnote markers, footnotes, and explanatory notes not to be stated on the test report)

(¹) For test cycle note the cycle indicated in Appendix 1 of Annexure 7

(²) Copy the results from table 6

(³) Reserved

(⁴) For an engine tested on a 5-mode cycle indicate the CO₂ emissions values given in that cycle from paragraph 9.3.

ANNEXURE – 3 **Labelling Requirements**

A3.1. The engine or the product must be affixed with a conformance label meeting the following requirements.

A3.1.1. General Requirement

- a. The label shall be durable and legible;
- b. The label shall be affixed on a part necessary for normal operation of the engine or the product and not normally requiring replacement during the life of the engine or the product;
- c. Statement that 'this engine or product conforms to the Environment Protection Rule 1986';
- d. All the information mentioned in the conformance label must be in English language;

A3.1.2. Conformance Labelling Content Requirement

- a. Name the engine manufacturer or the engine or product importer
- b. Manufacturing plant address from where engine is manufacture
- c. Engine Model name;
- d. Rated speed and corresponding gross power in kW;
- e. Engine Unique Identification Number (Serial Number, etc.);
- f. Date of manufacturing and in case of import, date of import of engine or Genset product;
- g. Type Approval certificate number;
- h. Letter 'G' to denote that the engine is belongs to genset application. The Letter 'G' shall be engraved on the conformance label. The letter(s) should have a minimum size of 7 mm.

Compliance name plate model

Manufacturer		<input type="text"/>	 <small>COMPANY LOGO</small>		G
Mfg. Plant		<input type="text"/>			
Engine Model	<input type="text"/>	Rated Speed (rpm)	<input type="text"/>	Power (kW)	<input type="text"/>
Engine Sr No	<input type="text"/>	Date of Mfg.	<input type="text"/>		
Type Approval Cert. No.		<input type="text"/>			
This engine or product conforms to the Environment Protection Rule 1986					

ANNEXURE – 4

Test equipment, test bed measurement system and test facility

A4.1 Requirement

A4.1.1 **Test facility:** The test facility to be used shall be of the certification agencies or any other facility approved by these certification agencies. The test Lab at Test Agency/ Engine Manufacturer Lab/ Third party Lab shall be accredited as per the requirement of ISO/IEC-17025 (NABL-National Accreditation Board for Testing and Calibration Laboratory) compliance for the related GSR/S&P/ISO-8178 Standards. The tests shall be carried out under the control of the certification agencies.

A4.1.2 **Test bed measurement system and equipment:** Test bed measurement system and equipment's of gaseous and particulate shall be as per the guideline given in the ISO-8178-1: 2017,2020 Reciprocating internal combustion engines — Exhaust emission measurement — Part 1: Test-bed measurement systems of gaseous and particulate emission.

Smoke measurement equipment shall be as per the guideline given in the ISO-8178-3: 2019 Reciprocating internal combustion engines — Exhaust emission measurement — Part 3: Test procedure for measurement of exhaust gas smoke emissions from compression ignition engines using a filter type smoke meter

Smoke measurement equipment shall be the guideline given in the ISO 8178-9:2019 Reciprocating internal combustion engines — Exhaust emission measurement — Part 9: Test cycles and test procedures for measurement of exhaust gas smoke emissions from compression ignition engines using an opacimeter

ANNEXURE-5

Data evaluation, test result calculation of gaseous & particulate emission, test execution and measurement procedures

A5.1 Requirement

A5.1.1 Method of test execution, measurement procedures, data evaluation and calculation of gaseous and particulate emission shall be as per the guideline given in the ISO-8178-4: 2017, 2020 Reciprocating internal combustion engines — Exhaust emission measurement — Part 4: Steady-state and transient test cycles for different engine applications

A5.1.2 Method of smoke measurement shall be as per the guideline given in the ISO-8178-3: 2019 Reciprocating internal combustion engines — Exhaust emission measurement — Part 3: Test procedure for measurement of exhaust gas smoke emissions from compression ignition engines using a filter type smoke meter

Method of smoke measurement shall be the guideline given in the ISO 8178-9:2019 Reciprocating internal combustion engines — Exhaust emission measurement — Part 9: Test cycles and test procedures for measurement of exhaust gas smoke emissions from compression ignition engines using an opacimeter

A5.1.3 1980 international gravity formula

The acceleration of Earth's gravity, a_g , varies depending on the location and a_g is: calculated for a respective latitude, as follows

$$a_g = 9.7803267715 \left[1 + 5.2790414 \times 10^{-3} \sin^2 \theta + 2.32718 \times 10^{-5} \sin^4 \theta + 1.262 \times 10^{-7} \sin^6 \theta + 7 \times 10^{-10} \sin^8 \theta \right]$$

Where: θ = Degrees north or south latitude

Note: Reference taken from AIS-137

ANNEXURE – 6

Technical characteristics of fuels prescribed for approval tests and to verify conformity of production tests

1. Technical data on fuels for testing compression-ignition engines

1.1. Type: Diesel

For Type approval and Conformity of Production (COP) test, fuel shall be Reference fuel or commercial fuel as recommended by manufacturer as prescribed in Table 1 and 2

Appendix – 1

Reference diesel fuel characteristics

Table 1				
Reference Diesel Fuel				
Parameter	Unit	Minimum	Maximum	Test method
Cetane Index		46.0		EN ISO 4264
Cetane number ²		52.0	56.0	EN ISO 5165
Density at 15 °C	kg/m ³	833.0	837.0	EN ISO 12185
Distillation:				
- 50% point	°C	245.0	—	EN ISO 3405
- 95% point	°C	345.0	360.0	EN ISO 3405
- final boiling point	°C	—	370.0	EN ISO 3405
Flash point	°C	55	—	EN ISO 2719
Cloud point	°C	-	-10	EN 23015
Viscosity at 40 °C	mm ² /s	2.30	3.30	EN ISO 3104
Polycyclic aromatic hydrocarbons	% m/m	2.0	4.0	EN 12916
Sulphur content	mg/kg	—	10.0	EN ISO 20846 EN ISO 20884
Copper corrosion 3hrs, 50 °C		—	Class 1	EN ISO 2160
Conradson carbon residue (10 % DR)	% m/m	—	0.20	EN ISO 10370
Ash content	% m/m	—	0.010	EN ISO 6245
Total contamination	mg/kg	-	24	EN 12662
Water content	mg/kg	—	200	EN ISO 12937
Acid number	mg KOH/g	—	0.10	EN ISO 6618
Lubricity (HFRR wear scan diameter at 60 °C)	Mm	—	400	EN ISO 12156
Oxidation stability @ 110 °C ³	H	20.0		EN 15751
FAME ⁴	% v/v	6.0	7.0	EN 14078
<p>1. The values quoted in the specifications are 'true values'. In establishment of their limit values the terms of ISO 4259 Petroleum products – Determination and application of precision data in relation to methods of test have been applied and in fixing a minimum value, a minimum difference of 2R above zero has been taken into account; in fixing a maximum and minimum value, the minimum difference is 4R (R = reproducibility). Notwithstanding this measure, which is necessary for technical reasons, the manufacturer of fuels shall nevertheless aim at a zero value where the stipulated maximum value is 2R and at the mean value in the case of quotations of maximum and minimum limits. Should it be necessary to clarify whether a fuel meets the requirements of the specifications, the terms of ISO 4259 shall be applied.</p> <p>2. The range for cetane number is not in accordance with the requirements of a minimum range of 4R. However, in the case of a dispute between fuel supplier and fuel user, the terms of ISO 4259 may be used to resolve such disputes provided replicate measurements, of sufficient number to archive the necessary precision, are made in preference to single determinations.</p> <p>3. Even though oxidation stability is controlled, it is likely that shelf life will be limited. Advice shall be sought from the supplier as to storage conditions and life.</p> <p>4. FAME content to meet the specification of EN 14214</p>				

Appendix – 2

Commercial diesel fuel characteristics

Table 2		
Commercial Diesel Fuel		
Characteristics	Unit	Requirements
Ash, max	% mass	0.01
Carbon Residue (Ramsbottom) on 10 % residue, max	% mass	0.3 without additives
Cetane number (CN), min		51
Cetane Index (CI), min		46
Distillation :		
95% vol. recovery at °C, max	°C	360
Flash point :		
a) Abel, min	°C	35
Kinematic Viscosity @ 40 °C	Cst	2.0-4.5
Density @15 °C	kg/m ³	845
Total Sulphur, max.	mg/kg	10
Water content, max	mg/kg	200
Cold filter Plugging point (CFPP)		
a) Summer, max	°C	18
b) Winter, max	°C	6
Total contaminations, max	mg/kg	24
Oxidation stability, max	g/m ³	25
Polycyclic Aromatic Hydrocarbon (PAH), max	% mass	11
Lubricity, corrected wear scar diameter @ 60 °C, max	µm (microns)	460
Copper strip corrosion for 3 hrs @ 50°C	Rating	Class – 1
FAME content max.	% v/v	7.0
Note : <ul style="list-style-type: none"> • Test methods and other provisions / details along with the requirements as given above shall be issued by Bureau of Indian Standards. • The Cetane number (CN),(min) shall be permitted up to 48 in North Eastern States till 01.04.2023 		

Appendix – 3

1.2. Type: Ethanol for dedicated compression ignition engines (ED95)1

Table 3

Ethanol for dedicated compression ignition engines (ED95)1				
<i>Parameter</i>	<i>Unit</i>	<i>Limits²</i>		<i>Test method³</i>
		<i>Minimum</i>	<i>Maximum</i>	
Total alcohol (Ethanol incl. content on higher saturated alcohols)	per cent m/m	92.4		EN 15721
Other higher saturated mono-alcohols (C ₃ -C ₅)	per cent m/m		2.0	EN 15721
Methanol	per cent m/m		0.3	EN 15721
Density 15°C	kg/m ³	793.0	815.0	EN ISO 12185
Acidity, calculated as acetic acid	per cent m/m		0.0025	EN 15491
Appearance		Bright and clear		
Flashpoint	°C	10		EN 3679
Dry residue	mg/kg		15	EN 15691
Water content	per cent m/m		6.5	EN 15489 ⁴ EN-ISO 12937 EN15692
Aldehydes calculated as acetaldehyde	per cent m/m		0.0050	ISO 1388-4
Esters calculated as ethylacetat	per cent m/m		0.1	ASTM D1617
Sulphur content	mg/kg		10.0	EN 15485 EN 15486
Sulphates	mg/kg		4.0	EN 15492
Particulate contamination	mg/kg		24	EN 12662
Phosphorus	mg/l		0.20	EN 15487
Inorganic chloride	mg/kg		1.0	EN 15484 or EN 15492
Copper	mg/kg		0.100	EN 15488
Electrical Conductivity	µS/cm		2.50	DIN 51627-4 or prEN 15938

¹ Additives, such as cetane improver as specified by the engine manufacturer, may be added to the ethanol fuel, as long as no negative side effects are known. If these conditions are satisfied, the maximum allowed amount is 10 per cent m/m.

² The values quoted in the specifications are "true values". In establishment of their limit values the terms of ISO 4259 Petroleum products – Determination and application of precision data in relation to methods of test have been applied and in fixing a minimum value, a minimum difference of 2R above zero has been taken into account; in fixing a maximum and minimum value, the minimum difference is 4R (R = reproducibility). Notwithstanding this measure, which is necessary for technical reasons, the manufacturer of fuels shall nevertheless aim at a zero value where the stipulated maximum value is 2R and at the mean value in the case of quotations of maximum and

minimum limits. Should it be necessary to clarify whether a fuel meets the requirements of the specifications, the terms of ISO 4259 shall be applied.

³ Equivalent EN/ISO methods will be adopted when issued for properties listed above.

⁴ Should it be necessary to clarify whether a fuel meets the requirements of the specifications, the terms of EN 15489 shall be applied.

Appendix – 4

2.0 Technical data on gaseous fuels for single fuel and dual-fuel engines

2.1 Type: LPG

Table 4

LPG				
<i>Parameter</i>	<i>Unit</i>	<i>Fuel A</i>	<i>Fuel B</i>	<i>Test method</i>
Composition:				EN 27941
C ₃ -content	per cent v/v	30 ± 2	85 ± 2	
C ₄ -content	per cent v/v	Balance ¹	Balance ¹	
< C ₃ , > C ₄	per cent v/v	Maximum 2	Maximum 2	
Olefins	per cent v/v	Maximum 12	Maximum 15	
Evaporation residue	mg/kg	Maximum 50	Maximum 50	EN 15470
Water at 0 °C		Free	Free	EN 15469
Total sulphur content including odorant	mg/kg	Maximum 10	Maximum 10	EN 24260, ASTM D 3246, ASTM 6667
Hydrogen sulphide		None	None	EN ISO 8819
Copper corrosion strip (1h at 40 °C)	Rating	Class 1	Class 1	ISO 6251 ²
Odour		Characterist ic	Characterist ic	
Motor octane number ³		Minimum 89.0	Minimum 89.0	EN 589 Annex B
<p><i>Notes:</i></p> <p>¹ Balance shall be read as follows: balance = 100 - C₃ - <C₃ - >C₄.</p> <p>² This method may not accurately determine the presence of corrosive materials if the sample contains corrosion inhibitors or other chemicals which diminish the corrosivity of the sample to the copper strip. Therefore, the addition of such compounds for the sole purpose of biasing the test method is prohibited.</p> <p>³ At the request of the engine manufacturer, a higher MON could be used to perform the type approval tests.</p>				

2.2. Type: Natural Gas/ Bio-methane

2.2.1. Specification for reference fuels supplied with fixed properties (eg from a sealed container)

As an alternative to the reference fuels set out in this paragraph, the equivalent fuels in paragraph 2.1.2. of this Annex may be used

Table 5

Natural Gas/ Bio-methane					
<i>Characteristics</i>	<i>Units</i>	<i>Basis</i>	<i>Limits</i>		<i>Test method</i>
			<i>minimum</i>	<i>maximum</i>	
Reference fuel G_R					
Composition:					
Methane		87	84	89	
Ethane		13	11	15	
Balance ¹	per cent mole	—	—	1	ISO 6974
Sulphur content	mg/m ³ ²	—		10	ISO 6326-5
<i>Notes:</i>					
¹ Inerts + C ₂₊					
² Value to be determined at standard conditions 293.2 K (20 °C) and 101.3 kPa.					
Reference fuel G₂₃					
Composition:					
Methane		92.5	91.5	93.5	
Balance ¹	per cent mole	—	—	1	ISO 6974
N ₂	per cent mole	7.5	6.5	8.5	
Sulphur content	mg/m ³ ²	—	—	10	ISO 6326-5
<i>Notes:</i>					
¹ Inerts (different from N ₂) + C ₂₊ C ₂₊					
² Value to be determined at 293.2 K (20 °C) and 101.3 kPa.					
Reference fuel G₂₅					
Composition:					
Methane	per cent mole	86	84	88	
Balance ¹	per cent mole	—	—	1	ISO 6974
N ₂	per cent mole	14	12	16	
Sulphur content	mg/m ³ ²	—	—	10	ISO 6326-5
<i>Notes:</i>					
¹ Inerts (different from N ₂) + C ₂₊ C ₂₊					
² Value to be determined at 293.2 K (20 °C) and 101.3 kPa.					
Reference fuel G₂₀					

Composition:					
Methane	per cent mole	100	99	100	ISO 6974
Balance ⁽¹⁾	per cent mole	—	—	1	ISO 6974
N ₂	per cent mole				ISO 6974
Sulphur content	mg/m ³ ⁽²⁾	—	—	10	ISO 6326-5
Wobbe Index (net)	MJ/m ³ ⁽³⁾	48.2	47.2	49.2	
<p>⁽¹⁾ Inerts (different from N₂) + C₂ + C₂+</p> <p>⁽²⁾ Value to be determined at 293.2 K (20 °C) and 101.3 kPa.</p> <p>⁽³⁾ Value to be determined at 273.2 K (0 °C) and 101.3 kPa.</p> <p>Note – In absence of availability of reference fuel for testing, commercial available fuel as notified under CMVR shall be used for testing</p>					

2.2.2. Specification for reference fuel supplied from a pipeline with admixture of other gases with gas properties determined by on-site measurement

As an alternative to the reference fuels in this paragraph the equivalent reference fuels in paragraph 2.2.1. of this Annex may be used.

2.2.2.1. The basis of each pipeline reference fuel (GR, G20, ...) shall be gas drawn from a utility gas distribution network, blended, where necessary to meet the corresponding lambda-shift (S_λ) specification in Table A.5-1, with an admixture of one or more of the following commercially (the use of calibration gas for this purpose shall not be required) available gases:

- (a) Carbon dioxide;
- (b) Ethane;
- (c) Methane;
- (d) Nitrogen;
- (e) Propane.

2.2.2.2. The value of S_λ of the resulting blend of pipeline gas and admixture gas shall be within the range specified in Table A.5-1 for the specified reference fuel.

Table A.5-1
Required range of S_λ for each reference fuel

Reference fuel	Minimum S _λ	Maximum S _λ
G _R ²	0.87	0.95
G ₂₀	0.97	1.03
G ₂₃	1.05	1.10
G ₂₅	1.12	1.20

¹ The engine shall not be required to be tested on a gas blend with a Methane Number (MN) less than 70. In the case that the required range of S_λ for G_R would result in an MN less than 70 the value of S_λ for G_R may be adjusted as necessary until a value of MN no less than 70 is attained.

2.2.2.3. The engine test report for each test run shall include the following:

- (a) The admixture gas(es) chosen from the list in paragraph 2.2.2.1. of this Annex;
- (b) The value of $S\lambda$ for the resulting fuel blend;
- (c) The Methane Number (MN) of the resulting fuel blend.

2.3 Fuels and their applicable standards:

Refer the applicable standards amended time to time for the fuels

Sr. No.	Fuel	Applicable Standard
1	Natural Gas	Annexure IV - L - CMVR Refer rule 115 H
2	Bio methane	IS 16087: 2016
3	LPG	IS 14861 : 2000 (REAFFIRMED 2020)
4	E10	IS 2796: 2017
5	E12	IS 17586: 2021
6	E15	IS 17586: 2021
7	E20	IS 17021: 2018
8	E85	IS 16634: 2017
9	E100	IS 15464: 2004
10	ED95	Is 16629: 2017
11	M15	IS 17076: 2019
12	M85	Annexure ZB - CMVR Refer rule 115 H
13	M100	IS 17075 : 2019
14	MD 95	Annexure ZA - CMVR Refer rule 115 H
15	DME	IS 16704: 2018
16	Hydrogen	IS 16061: 2021
17	Hydrogen blended with CNG (18% hydrogen)	IS 17314: 2019
18	Bio-Diesel (B7)	IS 1460 : 2017
19	Bio-diesel (B8 to B20)	IS 16531: 2022
20	Bio-diesel (B100)	IS 15607 : 2022

ANNEXURE – 7

Requirements, Tests and Test Procedures

7.1. General

Engines shall be designed, constructed and assembled so as to enable them to comply with the provisions of this Regulation.

7.1.1. The technical measures taken by the manufacturer shall be such as to ensure that the gaseous and particulate pollutant emissions are effectively limited, as set out in Table 1 of clause 3 of this Regulation throughout the emission durability period of the engine, as set out in Appendix 6 to this Annexure 7, and under normal conditions of use.

7.1.1.1. For this purpose, the engine final emission test result calculated according to the requirements of clause 7.1.2 shall not exceed the exhaust emission limits set out in Table 1 of clause 3, when:

- (a) tested in accordance with the test conditions and detailed technical procedures set out in Annexure 5 to this Regulation,
- (b) using the fuel(s) specified in paragraph 7.1.3.
- (c) using the test cycles specified in Appendix 1 to Annexure 7 of this Regulation.

7.1.2 The final exhaust emission test results for engines subject to this Regulation shall be calculated by applying all of the following to the laboratory test results:

- (a) the emissions of crankcase gases as required by Appendix 5 of Annexure 7;
- (b) any necessary adjustment factor, where the engine includes an infrequently regenerating exhaust after-treatment system;
- (c) in respect of all engines, as a final step in the calculation, deterioration factors appropriate to the emission durability periods specified in Appendix 6 to this Annexure 7 and calculated according to the prescription set out in Annexure 5.

7.1.3 In accordance to Annexure 7 of this Regulation, the testing of an engine type or engine family to determine whether it meets the emission limits set out in this Regulation shall be carried out by using the following reference fuels or fuel combinations, as appropriate:

- (a) Diesel
- (b) natural gas/Bio-methane
- (c) ethanol.
- (d) methanol

The engine type or engine family shall, in addition, meet the exhaust emission limits set out in this Regulation in respect of any other specified fuels, fuel mixtures or fuel emulsions included by a manufacturer in an application for type- approval and described in the Appendix 11 to paragraph 7 of this Regulation.

7.1.4 As regards the conduct of measurements and tests, the technical requirements shall be met in respect of:

- (a) apparatus and procedures for the conduct of tests;
- (b) apparatus and procedures for emission measurement and sampling;
- (c) methods for data evaluation and calculations;
- (d) methods for establishing deterioration factors;
- (e) methods for taking account of emissions of crankcase gases;

- (f) methods for determining and taking account of continuous or infrequent regeneration of exhaust after-treatment systems;
 - (g) in relation to electronically controlled engines, complying with the off-cycle emission limits set out in Regulation and using electronic control to determine both the quantity and timing of injecting fuel or using electronic control to activate, de-activate or modulate the emission control system used to reduce NO_x & PM;
 - (i) emission control strategies, and shall include the documentation required to demonstrate those strategies;
 - (ii) NO_x & PM control measures, and shall include the method used to demonstrate those control measures;
 - (iii) the area associated with the relevant steady-state test cycle, within which the amount by which the emissions are permitted to exceed the emission limits set out in Appendix 2 to this Annexure 7 is controlled;
 - (iv) the selection by the technical agency of additional measurement points from within the control area during the emission bench test;
- 7.1.5. Any adjustment, repair, disassembly, cleaning or replacement of engine components or systems which are scheduled to be performed on a periodic basis to prevent malfunction of the engine, shall only be done to the extent that is technologically necessary to ensure proper functioning of the emission control system.
- 7.2. Reserved
- 7.3. The technical requirements relating to emission control strategies as set out in Annexure 8 to this regulation shall apply;
- 7.4. The use of defeat strategies shall be prohibited;
- 7.5. Engine types and engine families shall be designed and fitted with emission control strategies in such a way as to prevent tampering to the extent possible;

Appendix – 1

Emission Test Cycles Introduction

1. Test cycles

The type-approval test shall be conducted using test cycle as specified in Table A for constant speed and variable speed application.

1.1 Steady-state test cycles

Steady-state test cycles are specified in below clause 2 of this Appendix as a list of discrete modes (operating points), where each operating point has one value of speed and one value of torque. A steady-state test cycle shall be measured with a warmed up and running engine according to manufacturer's specifications

1.2. Steady-state discrete mode test cycles

The steady-state discrete mode test cycles are hot running cycles where emissions shall be started to be measured after the engine is started, warmed up and running as per specified boundary conditions. Each cycle consists of a number of speed and load modes (with the respective weighing factor for each mode) which cover the typical operating range of the specified engine category.

1.3. Steady-state ramped mode test cycles

Steady-state ramped mode test cycles are hot running cycles where emissions shall be started to be measured after the engine is started, warmed up and running as per specified boundary conditions. Test cycle with a sequence of steady state engine test modes with defined speed and torque criteria at each mode and defined speed and torque ramps between these modes.

2. Characteristics of the steady-state test cycles

2.1. Test cycles applicable to Genset engine categories are set out in Table A

Table A-Test cycles

Test cycles for Genset engine categories			
Category	Speed operation	Purpose	Test Cycle
Genset	Constant speed engine	Constant speed engine upto 800 kW	D2 5-mode Steady-state discrete mode test cycle specified in ISO-8178-Part 4, OR D2 5-mode Steady-state ramped mode test cycle specified in ISO-8178-Part 4
	Variable speed engine	Variable speed engine upto 800 kW	5-mode Variable Speed Cycle, OR C1 8-mode Steady-state discrete mode test cycle specified in ISO-8178-Part 4), OR C1 8-mode Steady-state ramped mode test cycle specified in ISO-8178-Part 4

2.2. Steady-state constant speed and variable speed test cycles:

The detailed description of the test modes and weighting factors for the steady-state discrete-mode and ramped mode test cycles for constant speed and variable speed genset engines are set out in Tables B, C, D, E & F

2.2.1 Constant Speed Test Cycle

Table B- Discrete D2 test modes

Test modes and weighting factors					
Mode (cycle D2) number	1	2	3	4	5
Speed (a)	100%				
Torque (b) (%)	100	75	50	25	10
Weighting factor	0.05	0.25	0.3	0.3	0.1
Mode length (Second)	600	600	600	600	600

(a) Rated speeds as declared by manufactured
 (b) per cent torque is relative to the torque corresponding to the rated gross power declared by the manufacturer. Considering the applicable power tolerance, the torque setting for 2, 3, 4 & 5 mode, shall be based on actual torque measured at 1st mode during test.

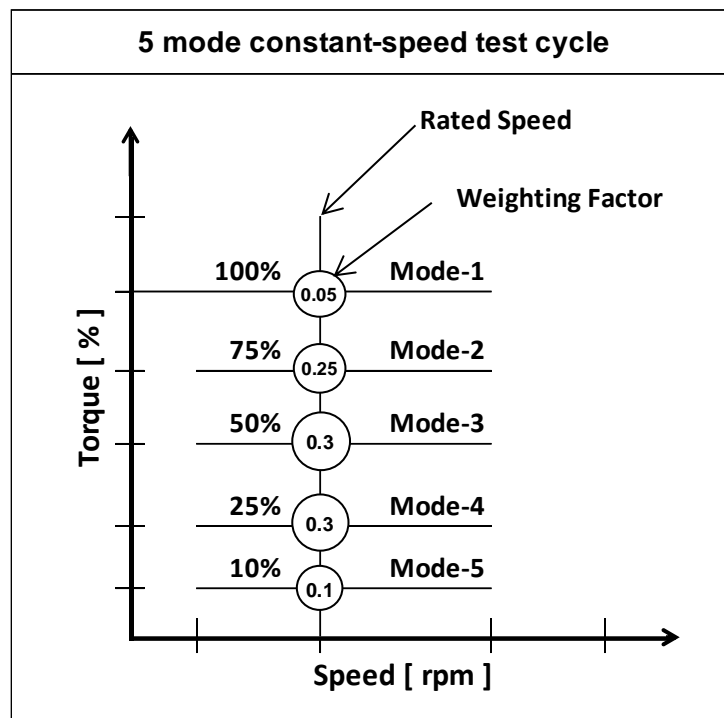

Table C —RMC-D2 test modes

RMC mode number	Time in mode (s)	Engine speed (%) a	Torque (%) b c
1a Steady State	53	100	100
1b Transition	20	100	Linear transition
2a Steady-state	101	100	10
2b Transition	20	100	Linear transition
3a Steady-state	277	100	75
3b Transition	20	100	Linear transition
4a Steady-state	339	100	25
4b Transition	20	100	Linear transition
5 Steady-state	350	100	50

a Rated speed as declared by manufacturer.

b % torque is relative to the torque corresponding to the rated power declared by the manufacturer.

c Advance from one mode to the next within a 20-second transition phase. During the transition phase, command a linear progression from the torque setting of the current mode to the torque setting of the next mode.

2.2.2 Variable speed test Cycle

**Table D- 5-mode variable speed test modes
Test modes and weighting factors**

Mode number	Engine Speed (a)	Power % (b)	Weighting factor	Mode length (Second)
1	Declared Speed (Rated speed)	100	0.05	600
2	Declared Speed	75	0.25	600
3	Declared Speed	50	0.30	600
4	Declared Speed	25	0.30	600
5	Declared Speed	10	0.10	600

(a) Pre-verified declared rated & part load speed as per Appendix 9 of this Annexure

(b) per cent power is relative to the power corresponding to the rated gross power declared by the manufacturer. Require torque values for dyno setting for each mode to be calculated based on the declared speed values

Note:

a) The engine manufacturer shall declare rated speed, rated power, and part load speeds of the engine. The part load speeds shall be as mentioned in above table. The part load speeds shall be verified on actual working condition of Genset at manufacturer's place by Test Agency before dismantling the set and submitting the engine for emission test.

b) Refer Appendix 9 of this Annexure -Test Procedure for emission measurement from Variable Speed Diesel Engines for Power generating set Application.

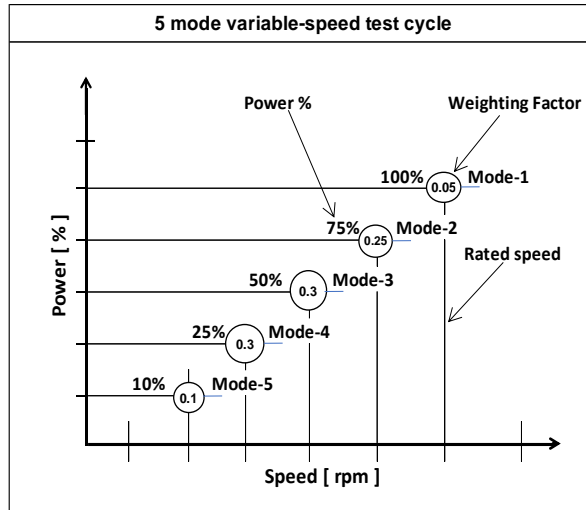

Table E — Discrete C1 test modes

Mode number	1	2	3	4	5	6	7	8
Speed a	100%				Intermediate			Idle
Torque b (%)	100	75	50	10	100	75	50	0
Weighting factor	0,15	0,15	0,15	0,1	0,1	0,1	0,1	0,15
a Refer ISO-8178 Part 4 for determination of required test speeds. b The % torque is relative to the maximum torque at the commanded engine speed.								

Table F —RMC-C1 test modes

RMC Mode Number	Time in mode(s)	Engine speed a c	Torque (%) b c
1a Steady-state	126	Idle	0
1b Transition	20	Linear transition	Linear transition
2a Steady-state	159	Intermediate	100
2b Transition	20	Intermediate	Linear transition
3a Steady-state	160	Intermediate	50
3b Transition	20	Intermediate	Linear transition
4a Steady-state	162	Intermediate	75
4b Transition	20	Linear transition	Linear transition
5a Steady-state	246	100%	100
5b Transition	20	100%	Linear transition
6a Steady-state	164	100%	10
6b Transition	20	100%	Linear transition
7a Steady-state	248	100%	75
7b Transition	20	100%	Linear transition
8a Steady-state	247	100%	50
8b Transition	20	Linear transition	Linear transition
9 Steady-state	128	Idle	0

a Refer ISO-8178 Part 4 for determination of required test speeds.
b % torque is relative to the maximum torque at the commanded engine speed.
c Advance from one mode to the next within a 20-second transition phase. During the transition phase, command a linear progression from the torque setting of the current mode to the torque setting of the next mode, and simultaneously command a similar linear progression for engine speed if there is a change in speed setting.

Note: Reference

ISO 8178-4:2017,2020;

Reciprocating internal combustion engines — Exhaust emission measurement — Part 4: Steady-state and transient test cycles for different engine applications.

Appendix – 2

Off Cycle Emission Requirements

Measurements and tests with regard to the control area associated with the steady-state test cycle applicable for constant speed engines & variable speed engines

A2.1. General Requirements:

This paragraph shall apply for constant speed electronically controlled Genset engines and variable speed electronically controlled Genset engines, complying with emission limits set out in Table 1 of clause 3 and using electronic control to determine both the quantity and timing of injecting fuel or using electronic control to activate, de-activate or modulate the emission control system used to reduce NO_x & PM

This paragraph sets out the technical requirements relating to the area associated with the relevant steady state test cycle, within which the amount by which that the emissions shall be permitted to exceed the emission limits set out in Table 1 of clause 3 to this paragraph is controlled

When an engine is tested as set out in test requirements as specified in below clause A2.4 of this Appendix 2, the emission of gaseous and particulate pollutants sampled at any randomly selected point within the applicable control area set out in clause A2.2.2 shall not exceed the applicable emission limit values in Table 1 of clause 3 of this Regulation multiplied by a factor of 2.0;

Paragraph A2.2.2. sets out the selection by the technical agency of additional measurement points from within the control area during the emission bench test, in order to demonstrate that the requirements of this paragraph have been met;

The installation instructions provided by the manufacturer to the GOEM in accordance with Appendix 1 to Annexure 9 of this Regulation shall identify the upper and lower boundaries of the applicable control area and shall include a statement to clarify that the GOEM shall not install the engine in such a way that it constrains the engine to operate permanently at only combinations of speed and torque outside of the control area for the torque curve corresponding to the approved engine type or engine family;

A2.2. Engine control area

The applicable control area for conducting the engine test shall be the area identified in this paragraph that corresponds to the applicable steady state cycle for the engine being tested; number of random points within control area for testing during the type approval and COP testing as well.

- a) up to two points for constant speed genset engine operating on D2 cycle
- b) up to two points for variable speed genset engine operating on variable speed 5-mode test cycle
- c) up to three points for variable speed genset engine operating on C1 cycle

A2.2.2. Control area

a) Control area for constant speed engines tested with D2 cycle

These engines are mainly operated very close to their designed operating speed; hence the control area is defined as:

- Speed: 100 per cent

- Torque range: 50 per cent to the torque corresponding to maximum power.

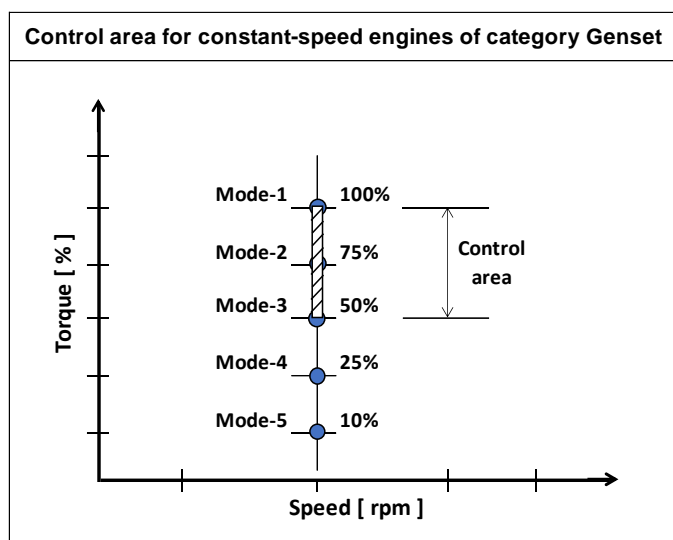

b) Control area for variable speed engines tested with variable speed 5-mode test cycle

- Speed: 50 per cent to the power corresponding to maximum power
- Torque range: 50 per cent to the power corresponding to maximum power.

c) Control area for variable speed engines tested with C1 test cycle

These engines operate with variable speed and load. The control area, as shown in following Figure, is defined as follows:

- upper torque limit: full load torque curve
- speed range: speed A to n_{hi} ;
- torque range: 30 % to 100 %;

where:

- speed A = $n_{lo} + 0,15 (n_{hi} - n_{lo})$;
- speed B = $n_{lo} + 0,50 (n_{hi} - n_{lo})$;
- speed C = $n_{lo} + 0,75 (n_{hi} - n_{lo})$;

with

n_{lo}	low speed (lowest engine speed where 50 % of the maximum power occurs)
n_{hi}	high speed (highest engine speed where 70 % of the maximum power occurs)
for more details refer ISO 8178 Part-4 on determination of n_{lo} , n_{hi}	

If the measured engine speeds A, B and C are within ± 3 % of the engine speeds declared by the manufacturer, the declared engine speeds shall be used. If the tolerance is exceeded for any of the test speeds, the measured engine speeds shall be used.

The following speed and torque points shall be excluded from the control area:

- points below 30 % of maximum power;
- for particulate matter only, if the C speed is below 2 400 r/min, points to the right of or below the

- line formed by connecting the points of 30 % of maximum torque or 30 % of maximum power, whichever is greater, at the B speed and 70 % of maximum power at the high speed;
- for particulate matter only, if the C speed is above 2 400 r/min, points to the right of the line formed by connecting the points of 30 % of maximum torque or 30 % of maximum power, whichever is greater, at the B speed, 50 % of maximum power at 2 400 r/min, and 70 % of maximum power at the high speed.

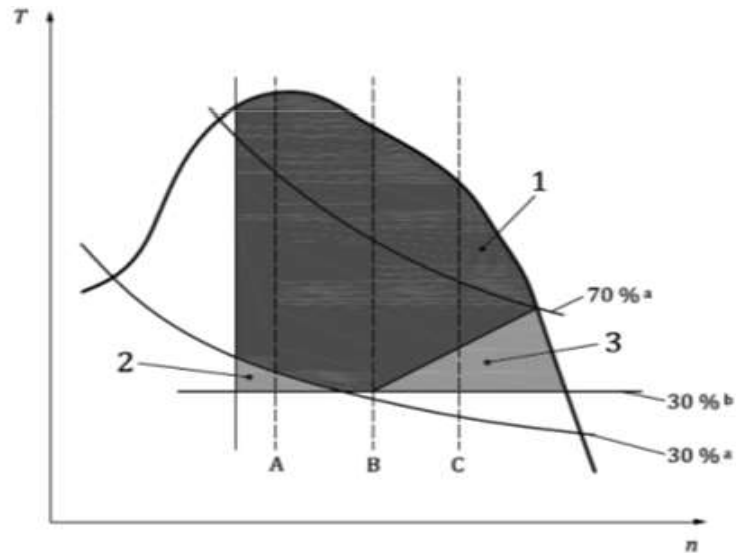

- Key**
- n speed (%)
 - T torque (% of maximum)
 - 1 engine Control Area
 - 2 All Emissions Carve-Out
 - 3 PM Carve-Out
 - ^a % of maximum net power
 - ^b % of maximum torque

Figure – Engine control area for Engines tested to cycles C1, C < 2 400 rpm

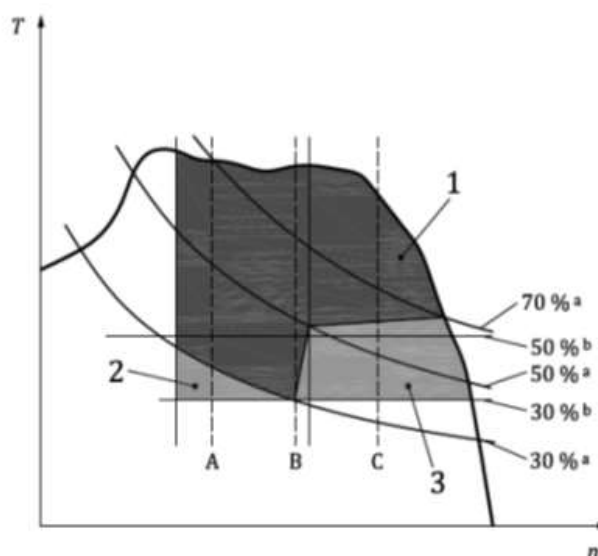

- Key**
- n speed (%)
 - T torque (% of maximum)
 - 1 Engine Control Area
 - 2 All Emissions Carve-Out
 - 3 PM Carve-Out
 - a % of maximum net power
 - b % of maximum torque

Figure 1 – Engine control area for Engines tested to cycles C1, C > 2400 rpm

A2.3. Demonstration requirements

A2.3.1. The test agency shall select random load points within the control area for testing.

- i) For engines subject to paragraph A2.2.2. a) & b), two points shall be selected.
 1. One random point between 50 to 75% torque points but excluding these two;
 2. One random point between 75 to 100% torque points but excluding these two;
- ii) For engines subject to paragraph A2.2.2. c), three points shall be selected.
 1. One random point between 30 to 50% torque points but excluding 50% torque point
 2. One random point between 50 to 75% torque points but excluding these two;
 3. One random point between 75 to 100% torque points but excluding these two;

The test agency shall also determine a random running order of the test points;

The test shall be run at Standard lab (NTP) conditions in accordance with the principal requirements of the ISO 8178 D2 constant speed cycle but each test point shall be evaluated separately;

A2.3.2. For the purpose of the random selections required in paragraph A2.3.1. recognised statistical methods of randomization shall be used.

A2.4. Test requirements

The test shall be carried out immediately after the applicable test cycle as follows:

- (a) the test of the randomly selected torque points shall be carried out immediately after the steady state test sequence and before the post test procedures.
- (b) the tests shall be carried out using the multiple filter method (one filter for each test point) for each of the test points chosen in accordance with paragraph A2.3.;
- (c) a specific emission value shall be calculated (in g/kWh) for each test point;
- (d) emissions values may be calculated on a mass basis or on a molar basis using Annexure 5, but shall be consistent with the method used for the steady state test;
- (e) for gaseous emissions, a weighting factor of 1 shall be used;
- (f) for particulate calculations the multiple filter method shall be used; and a weighting factor of 1 shall be used.

A2.5 Regeneration

In the case that a regeneration event occurs during or immediately preceding the procedure in paragraph A2.4., upon completion of that procedure the test may be voided at the request of the manufacturer irrespective of the cause of the regeneration. In this case the test shall be repeated. The same torque points shall be used although the running order may be changed. It shall not be deemed necessary to repeat any torque points for which a pass result has already been obtained. The following procedure shall be used for the repeat test:

- (a) The engine shall be operated in a manner to ensure that the regeneration event has completed and, where applicable, the soot load in the particulate after-treatment has been re-established;
- (b) The engine warm-up procedure shall be performed.
- (c) The test procedure specified in paragraph A2.4. shall be repeated commencing at sub-paragraph A2.4. (b).

Note: Reference

ISO 8178-4:2017,2020;

Reciprocating internal combustion engines — Exhaust emission measurement — Part 4: Steady-state and transient test cycles for different engine applications

Appendix – 3

Method for measuring Smoke

A3.1 Method of smoke measurement shall be as per the guideline given in the ISO-8178-3: 2019 Reciprocating internal combustion engines — Exhaust emission measurement — Part 3: Test procedure for measurement of exhaust gas smoke emissions from compression ignition engines using a filter type smoke meter

Method of smoke measurement shall be the guideline given in the ISO 8178-9:2019 Reciprocating internal combustion engines — Exhaust emission measurement — Part 9: Test cycles and test procedures for measurement of exhaust gas smoke emissions from compression ignition engines using an opacimeter

A3.2 Smoke limit is 0.7 m^{-1} & is applicable to type approval and as well conformity of production

A3.3 Smoke shall not exceed the limit value throughout the operating load points of the test cycles;

A3.4 If the measurement of smoke is in different unit, then to be convert it in m^{-1} unit with acceptable conversion formula

A3.4 For verifying the conformity of production, if the selected engine does not meet the smoke limit as applicable, the another two engines in case above 19 kW power rating or four engines in case below 19 kW power rating, will be taken from the series at random and be tested as per this part. This selected all engines should meet the limit values specified. One engine shall be subjected to the emission test for the conformance of production.

Appendix – 4

Gross Power Measurement Procedure

- 1.0 Declared power (kWm) means rated gross mechanical power declared by manufacturer for type approval at declared rated speed.
- 2.0 Gross observed power shall be the criteria for adjusting dynamometer load as well as calculating the specific emission values
- 3.0 The declared rated gross power shall be verified with the observed gross corrected power as mentioned below. Certification Power verification will be at reference atmospheric condition.
- 4.0 Power observed in the emission test cycle for all test mode points shall be corrected as per mentioned below formula and 1st mode corrected power is the corrected rated gross power.
- 5.0 Power Corrections Factors:

Definition: The power correction factor is the coefficient by which the measured power must be multiplied to determine the engine power under the reference atmospheric conditions specified as below

$$P_{\text{corr}} = \alpha P_{\text{obs}}$$

Where,

P_{corr} is the corrected power (i.e. power under reference atmospheric conditions)

α is the correction factor

P_{obs} is the measured power (test power)

Reference atmospheric conditions:

- Temperature (T): 298 K
- Dry pressure (Ps): 99 kPa

Note: The dry pressure is based on a total pressure of 100 kPa and a water vapour pressure of 1 kPa.

Test atmospheric conditions:

- The atmospheric conditions during the test shall be the following:
- Temperature (T): Between 283 K and 313 K
- Pressure (P): Between 80 kPa and 110 kPa

Determination of correction factor:

(The tests may be carried out in air -conditioned tests rooms where the atmospheric conditions may be controlled.)

The power correction factor α for diesel engines at constant fuel delivery is obtained by applying the formula:

$$\alpha = f_a f_m$$

where,

f_a – the atmospheric factor

f_m - the characteristic parameter for each type of engine and adjustment

Atmospheric factor (f_a):

This factor indicates effect of environmental conditions (pressure, temperature and

humidity) on the air drawn in by the engine. The atmospheric factor differs according to the type of the engines.

- Naturally aspirated and mechanically pressure charged engines:
 $f_a = (99/P_s) \times (T/298)^{0.7}$
- Turbocharged engines with or without cooling of charge air:
 $f_a = (99/P_s)^{0.7} \times (T/298)^{1.5}$

Engine Factor (f_m):

f_m is a function of Q_c (fuel flow corrected) as follows,

$$f_m = 0.036 Q_c - 1.14$$

where, Q_c is Q/r and

Q – the fuel delivery in milligrams/cycle per litre of engine swept volume (mg/1.cycle)

r is the pressure ratio of compressor outlet and compressor inlet ($r = 1$ for naturally aspired engines)

Note:

- a. This formula is valid when Q_c is $40 \leq Q_c \leq 65$
- b. For Q_c values lower than 40, a constant value of f_m equal to 0.3 ($f_m=0.3$) will be taken
- c. For Q_c values higher than 65, a constant value of f_m equal to 1.2 ($f_m=1.2$) will be taken

- 6.0 The gross declared corrected power of the engine shall be measured on a test bench at rated speed of the engine. The measured power and speed may differ from the power and speed specified by the manufacturer as specified below:

Declared rated corrected gross Power & speed tolerance

➤ **For Constant speed engine**

- (i) For Type Approval:
 - For single cylinder engines, $\pm 5\%$ at the rated power point
 - For all other engines, $\pm 4\%$ at the rated power point
- (ii) For Conformity of Production:
 - For single cylinder engines, at rated power point, $\pm 6\%$ of the type approved figure
 - For all other engines, at rated power point, $\pm 5\%$ of the type approved figure

Declared rated Speed at rated power point shall vary within $\pm 1\%$

➤ **For Variable speed engine**

- (i) For Type Approval:
 - For single cylinder engines, $\pm 5\%$ at rated & part load power point
 - For all other engines, $\pm 4\%$ at rated & part load power point
- (ii) For Conformity of Production:
 - For single cylinder engines, at rated & part load power point, $\pm 6\%$ of the type approved figure
 - For all other engines, at rated & part load power point, $\pm 5\%$ of the type approved figure

Declared rated & part load speeds shall vary within $\pm 1\%$

- 7.0 For verifying the conformity of production, for the selected engine, if the gross power and rated speed does not meet the limits, two additional engines for $>19\text{kW}$ or four in case $<19\text{kW}$ power rating category shall be tested for the rated gross power and rated speed.

The additional selected all engines shall meet the limits for the rated gross power and speed, out of these engines, one engine shall be subjected to the emission test for the conformance of production as mentioned in this part.

- 8.0 The fuel temperature shall be maintained at 38 ± 5 deg C throughout the test
- 9.0 Single & two-cylinder engines shall be tested with the engine intake system. All the other engine shall be tested with either air intake system of applying maximum declared air intake depression of clean air intake
- 10.0 The engine shall be tested with the maximum exhaust back pressure values declared by the manufacturer. In case of the engines fitted with exhaust after treatment device and external EGR system, the manufacturer shall declare exhaust back pressure values at all five test points. The engine will be tested with the declared exhaust back pressure values set at laboratory condition with a tolerance of $\pm 10\%$ at rated load. At part load points the tolerance shall be as low as possible in the test laboratory conditions.
- 11.0 The no load speed or high idle speed and overload speed (correspondence to % overload power declared by manufacturer) shall be verified and documented against value specified by the manufacturer.

Appendix – 5

Crankcase Ventilation Requirements

The Regulation does not enforce a specific crankcase ventilation system for Genset engines. With option of Open and Close crankcase ventilation systems, verifying emissions of crankcase gases is required for engines with gross power >56 kW.

Crank case ventilation requirement shall be as per the guideline given in the ISO-8178-4: 2017, 2020 Reciprocating internal combustion engines — Exhaust emission measurement — Part 4: Steady-state and transient test cycles for different engine applications

Appendix – 6

Emission Durability Period (EDP), Deterioration Factor and Methodology for Adapting Emission Lab Test Results

1. Definitions

For the purposes of this appendix, the following definitions apply. Refer clause 2.1 for extensive set of definitions:

- 1.1. **“Ageing cycle”** means the engine operation (speed, load, power) to be executed during the service accumulation period.
- 1.2. **“Critical emission-related components”** means the exhaust after- treatment system, the electronic engine control unit and its associated sensors and actuators, and the EGR system including all related filters, coolers, control valves and tubing.
- 1.3. **“Critical emission-related maintenance”** means the maintenance to be performed on critical emission-related components of the engine.
- 1.4. **“Emission-related maintenance”** means the maintenance which substantially affects emissions or which is likely to affect emissions performance of the engine during normal in-use operation.
- 1.5. **“Engine-after-treatment system family”** means a manufacturer’s grouping of engines that comply with the definition of engine family, but which are further grouped into a family of engine families utilising a similar exhaust after-treatment system.
- 1.6. **“Non-emission-related maintenance”** means maintenance which does not substantially affect emissions and which does not have a lasting effect on the emissions performance deterioration of the engine during normal in-use operation once the maintenance is performed.
- 1.7. **“Service accumulation schedule”** means the ageing cycle and the service accumulation period for determining the deterioration factors for the engine-after-treatment system family.

2. General

- 2.1. This Appendix details the procedures for selecting engines to be tested over a service accumulation schedule for the purpose of determining deterioration factors for engine type approval and conformity of production assessments. The deterioration factors shall be applied to the emissions measured in accordance with Annex 4 and calculated in accordance with Annex 5 in accordance with the procedure set out in paragraph 3.2.7 of this appendix, respectively.
- 2.2. The service accumulation tests or the emissions tests performed to determine deterioration need not be witnessed by the Type Approval Authority.
- 2.3. This appendix also details the emission-related and non-emission-related maintenance that should be or may be carried out on engines undergoing a service accumulation schedule. Such maintenance shall conform to the maintenance performed on in-service engines and communicated to the end-users of new engines.

3. Engine categories Genset

- 3.1. Selection of engines for establishing emission durability period deterioration factors
 - 3.1.1. Engines shall be selected from the engine family defined in Clause 4.1 to establish emission durability period deterioration factors.
 - 3.1.2. Engines from different engine families may be further combined into families based on the type of exhaust after-treatment system utilised, or where no after-treatment is used, based upon the

similarity of the technical characteristics of the emission control system. Engines of different bore and stroke, different configuration, different air management systems, different fuel systems may be considered as equivalent in respect to emissions deterioration characteristics if the manufacturer provides data to the Type Approval Authority that there is a reasonable technical basis for such determination. In order to place engine families having similar technical specifications and installation for the exhaust after-treatment systems into the same engine after-treatment system family, the manufacturer shall provide data to the Type Approval Authority that demonstrates that the emissions reduction performance of such engines is similar.

- 3.1.3. The test engine shall represent the emission deterioration characteristics of the engine families that will apply the resulting deterioration factors for type approval. The engine manufacturer shall select one engine representing the engine family, group of engine families or engine-after-treatment system family, as determined in accordance with paragraph 3.1.2. of this Appendix, for testing over the service accumulation schedule referred to in paragraph 3.2.2. of this Appendix, which shall be reported to the Type Approval Authority before any testing commences.
- 3.1.4. If the Type Approval Authority decides that the worst-case emissions of the engine family, group of engine families or engine-after-treatment system family can be better characterised by another test engine, the test engine to be used shall be selected jointly by the Type Approval Authority and the engine manufacturer.

3.2. Determination of emission durability period deterioration factors

3.2.1. General

Deterioration factors applicable to an engine family, group of engine families or engine-after-treatment system family shall be developed from the selected engines based on a service accumulation schedule that includes periodic testing for gaseous and particulate emissions over each test cycle applicable to the engine category.

- 3.2.1.1. At the request of the manufacturer, the Type Approval Authority may allow the use of deterioration factors that have been established using alternative procedures to those specified in paragraphs 3.2.2. to 3.2.5. of this Appendix. In that case, the manufacturer shall demonstrate to the satisfaction of the Type Approval Authority that the alternative procedures used are not less rigorous than those set out in paragraphs 3.2.2. to 3.2.5. of this Annex.

3.2.2. Service accumulation schedule

Service accumulation schedules may be carried out at the choice of the manufacturer by running a Genset equipped with the selected engine over an "in-service" accumulation schedule or by running the selected engine over a "dynamometer service" accumulation schedule. The manufacturer shall not be required to use reference fuel for the service accumulation in-between emission measurement test points.

3.2.2.1. In-service and dynamometer service accumulation

- 3.2.2.1.1. The manufacturer shall determine the form and duration of the service accumulation and the ageing cycle for engines in a manner consistent with good engineering judgment.

- 3.2.2.1.2. The manufacturer shall determine the test points where gaseous and particulate emissions will be measured over the applicable cycles, as follows:

- 3.2.2.1.2.1. When running a service accumulation schedule shorter than the emission durability period in accordance with paragraph 3.2.2.1.7. of this Appendix, the minimum number of test points shall be three, one at the beginning, one approximately in the middle and one at the end of the service accumulation schedule.

- 3.2.2.1.2.2. When completing the service accumulation up to the end of the emission durability period, the minimum number of test points shall be two, one at the beginning and one at the end of the service accumulation.

- 3.2.2.1.2.3. The manufacturer may additionally test at evenly spaced intermediate points.

- 3.2.2.1.3. The emission values at the start point and at the emission durability period endpoint either calculated in accordance with paragraph 3.2.5.1. of this Appendix or measured directly in accordance with paragraph 3.2.2.1.2.2. of this Appendix, shall be within the limit values applicable to the engine family. However individual emission results from the intermediate test points may exceed those limit values.
- 3.2.2.1.4. Type Approval Authority to run only one test cycle (applicable 5-mode emission cycle) at each test point
- 3.2.2.1.5. Reserved
- 3.2.2.1.6. Service accumulation schedules may be different for different engine-after-treatment system families.
- 3.2.2.1.7. Service accumulation schedules may be shorter than the emission durability period, but shall not be shorter than the equivalent of at least one quarter of the relevant emission durability period as specified in below table

Emission durability period for Genset Engines > 19KW

Category (Power Band)	Emission durability period (hours)
>19 ≤ 56 kW (constant speed Engines)	3000
>19 ≤ 56 KW (Variable speed Engines)	5000
> 56 kW (All engines)	8000

- 3.2.2.1.8. Accelerated ageing by adjusting the service accumulation schedule on a fuel consumption basis is permitted. The adjustment shall be based on the ratio between the typical in-use fuel consumption and the fuel consumption on the ageing cycle, but fuel consumption on the ageing cycle shall not exceed typical in-use fuel consumption by more than 30 per cent.
- 3.2.2.1.9. At the request of the manufacturer and with the agreement of the Type Approval Authority, alternative methods of accelerated ageing may be permitted.
- 3.2.2.1.10. The service accumulation schedule shall be fully described in the application for type-approval and reported to the Type Approval Authority before the start of any testing.
- 3.2.2.2. If the Type Approval Authority decides that additional measurements need to be performed between the points selected by the manufacturer it shall notify the manufacturer. The revised service accumulation schedule shall be prepared by the manufacturer and agreed by the Type Approval Authority.

3.2.3. Engine testing

3.2.3.1. Engine stabilisation

3.2.3.1.1. For each engine-after-treatment system family, the manufacturer shall determine the number of hours of engine running (or a Genset application) after which the operation of the engine-after-treatment system has stabilised. If requested by the Type Approval Authority, the manufacturer shall make available the data and analysis used to make this determination. As an alternative, the manufacturer may run the engine or a Genset between 60 and 125 hours or the equivalent time on the ageing cycle to stabilise the engine-after-treatment system.

3.2.3.1.2. The end of the stabilisation period determined in paragraph 3.2.3.1.1. of this Appendix shall be deemed to be the start of the service accumulation schedule.

3.2.3.2. Service accumulation testing

3.2.3.2.1. After stabilisation, the engine shall be run over the service accumulation schedule selected by the manufacturer, as described in paragraph 3.2.2. of this Appendix. At the periodic intervals in the service accumulation schedule determined by the manufacturer, and, where applicable, decided by the Type Approval Authority in accordance with paragraph 3.2.2.2. of this Appendix, the engine shall be tested for gaseous and particulate emissions over steady state cycle as applicable to the engine category

The manufacturer may select to measure the pollutant emissions before any exhaust after-treatment system separately from the pollutant emissions after any exhaust after-treatment system.

In accordance with paragraph 3.2.2.1.4. of this Appendix, if it has been agreed that only one steady state test cycle (applicable 5-mode emission cycle) be run at each test point, at the beginning and at the end of the service accumulation schedule.

- 3.2.3.2.2. During the service accumulation schedule, maintenance shall be carried out on the engine in accordance with paragraph 3.4. of this Appendix.
- 3.2.3.2.3. During the service accumulation schedule, unscheduled maintenance on the engine may be performed, for example if the manufacturer's normal diagnostic system has detected a problem that would have indicated to genset operator that a fault had arisen.

3.2.4. Reporting

- 3.2.4.1. The results of all emission tests (applicable 5-mode emission cycle) conducted during the service accumulation schedule shall be made available to the Type Approval Authority. If an emission test is declared to be void, the manufacturer shall provide reasons why the test has been declared void. In such a case, another series of emission tests shall be carried out within the following 100 hours of service accumulation.
- 3.2.4.2. The manufacturer shall retain records of all information concerning all the emission tests and maintenance carried out on the engine during the service accumulation schedule. This information shall be submitted to the Type Approval Authority along with the results of the emission tests conducted over the service accumulation schedule.
- 3.2.5. Determination of deterioration factors
 - 3.2.5.1. When running a service accumulation schedule in accordance with paragraph 3.2.2.1.2.1. or paragraph 3.2.2.1.2.3. of this Appendix, for each pollutant measured over the applicable D2-5-mode emission cycle at each test point during the service accumulation schedule, a "best fit" linear regression analysis shall be made on the basis of all test results. The results of each test for each pollutant shall be expressed to the same number of decimal places as the limit value for that pollutant, as applicable to the engine family, plus one additional decimal place.

Where in accordance with paragraph 3.2.2.1.4. or paragraph 3.2.2.1.5. of this Appendix, only one steady state test cycle (applicable 5-mode emission cycle) has been run at each test point, the regression analysis shall be made only on the basis of the test results from the test cycle run at each test point.

The manufacturer may request the prior approval of the Type Approval Authority for a non-linear regression.

- 3.2.5.2. The emission values for each pollutant at the start of the service accumulation schedule and at the emission durability period end point that is applicable for the engine under test shall be either:
 - (a) determined by extrapolation of the regression equation in paragraph 3.2.5.1. of this Appendix, when running a service accumulation schedule in accordance with paragraph 3.2.2.1.2.1. or paragraph 3.2.2.1.2.3. of this Appendix, or
 - (b) measured directly, when running a service accumulation schedule in accordance with paragraph 3.2.2.1.2.2. of this Appendix.

Where emission values are used for engine families in the same engine-after-treatment family or group of engine families but with different emission durability periods, then the emission values at the emission durability period end point shall be recalculated for each emission durability period by extrapolation or interpolation of the regression equation as determined in paragraph 3.2.5.1. of this Appendix.

- 3.2.5.3. The deterioration factor (DF) for each pollutant is defined as the ratio of the applied emission values at the emission durability period end point and at the start of the service accumulation schedule (multiplicative deterioration factor).

The manufacturer may request the prior approval of the Type Approval Authority for the application of an additive DF for each pollutant may be applied. The additive DF is defined as the difference between the calculated emission values at the emission durability period end point and at the start of the service accumulation schedule.

An example for determination of DFs by using linear regression is shown in Figure A.8-1. for NOX emission.

Mixing of multiplicative and additive DFs within one set of pollutants is not permitted.

If the calculation results in a value of less than 1.00 for a multiplicative DF, or less than 0.00 for an additive DF, then the deterioration factor shall be 1.0 or 0.00, respectively.

In accordance with paragraph 3.2.2.1.4. of this Appendix, if it has been agreed that only one steady state test cycle (D2 5-mode) be run at each test point

Figure A.8-1.
Example of DF determination

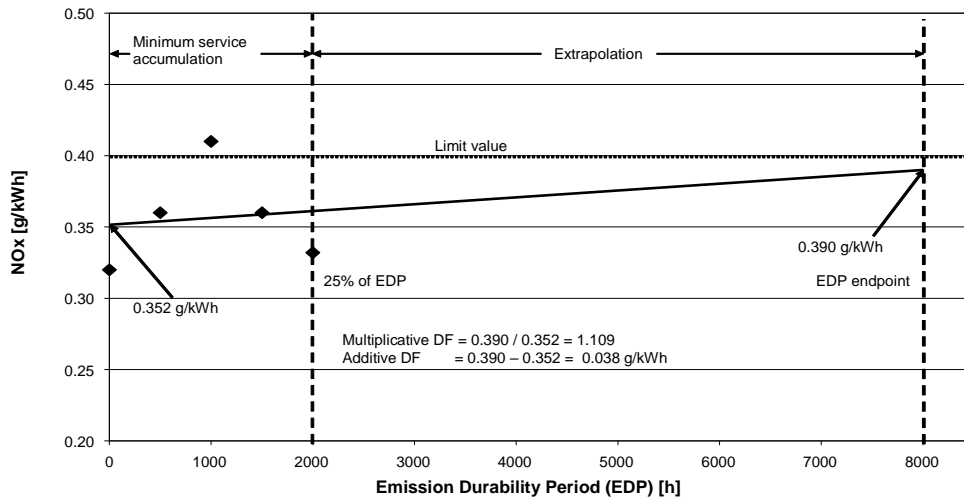

3.2.6. Assigned deterioration factors

3.2.6.1. As an alternative to using a service accumulation schedule to determine DFs, engine manufacturers may select to use assigned multiplicative DFs, as given in Table A.6-1.

Table A.6-1.

Assigned deterioration factors

Category (Power Band)	Deterioration Factors (DF)			
	CO	HC	NOx	PM
>19 kW (Constant / Variable Speed Engine)	1.3	1.3	1.15	1.05

Note: When opted for assigned multiplicative DF, no verification is required.

Assigned additive DFs shall not be given. The assigned multiplicative DFs shall not be transformed into additive DFs.

3.2.6.2. Where assigned DFs are used, the manufacturer shall present to the Type Approval Authority robust evidence that the emission control components can reasonably be expected to have the emission durability associated with those assigned factors. This evidence may be based upon design analysis, or tests, or a combination of both.

3.2.7. Application of deterioration factors

3.2.7.1. The engines shall meet the respective emission limits for each pollutant, as applicable to the engine family, after application of the deterioration factors to the test result as measured in accordance with Annex 5 (cycle-weighted specific emission for particulate and each individual gas). Depending on the type of DF, the following provisions apply:

(a) Multiplicative: (cycle weighted specific emission) * DF ≤ emission limit

(b) Additive: (cycle weighted specific emission) + DF ≤ emission limit

Cycle weighted specific emission may include the adjustment for infrequent regeneration, where applicable.

3.2.7.2. For a multiplicative NO_x + HC DF, separate HC and NO_x DFs shall be determined and applied separately when calculating the deteriorated emission levels from an emissions test result before combining the resultant deteriorated NO_x and HC values to establish compliance with the emission limit.

3.2.7.3. The manufacturer may carry across the DFs determined for an engine-after-treatment system family to an engine that does not fall into the same engine-after-treatment system family. In such cases, the manufacturer shall demonstrate to the Type Approval Authority that the engine for which the engine-after-treatment system family was originally tested and the engine for which the DFs are being carried across have similar technical specifications and installation requirements on the Genset and that the emissions of such engine are similar.

Where DFs are carried across to an engine with a different emission durability period, the DFs shall be recalculated for the applicable emission durability period by extrapolation or interpolation of the regression equation as determined in paragraph 3.2.5.1. of this Appendix.

3.2.7.4. The DF for each pollutant for each applicable test cycle shall be recorded in the test report set out in Annexure 2.

3.3. **Checking of conformity of production**

3.3.1. Conformity of production for emissions compliance is checked on the basis clause 5.

3.3.2. The manufacturer may measure the pollutant emissions before any exhaust after-treatment system at the same time as the type-approval test is being performed. For that purpose, the manufacturer may develop informal DFs separately for the engine without after-treatment system and for the after-treatment system that may be used by the manufacturer as an aid to end of production line auditing.

3.3.3. For the purposes of approval, only the DFs determined in accordance with paragraph 3.2.5. or 3.2.6. of this Appendix shall be recorded in the test report set out in Annexure 2.

3.4. **Maintenance**

For the purpose of the service accumulation schedule, maintenance shall be performed in accordance with the manufacturer's manual for service and maintenance.

3.4.1. Scheduled emission-related maintenance

3.4.1.1. Scheduled emission-related maintenance during engine running, undertaken for the purpose of conducting a service accumulation schedule, shall occur at equivalent intervals to those that are specified in the manufacturer's maintenance instructions to the end-user of the engine. This schedule maintenance may be updated as necessary throughout the service accumulation schedule provided that no maintenance operation is deleted from the maintenance schedule after the operation has been performed on the test engine.

3.4.1.2. Any adjustment, disassembly, cleaning, or exchange of critical emission-related components which is performed on a periodic basis within the emission durability period to prevent malfunction of the engine, shall only be done to the extent that is technologically necessary to ensure proper functioning of the emission control system. The need for scheduled exchange, within the service accumulation schedule and after a certain running time of the engine, of critical emission-related components other than those qualifying as routine exchange items shall be avoided. In this context, consumable maintenance items for regular renewal or items that require cleaning after a certain running time of the engine, shall qualify as routine exchange items.

3.4.1.3. Any scheduled maintenance requirements shall be subject to approval by the Type Approval Authority before type-approval is granted and shall be included in the customer's manual. The Type Approval Authority shall not refuse to approve maintenance requirements that are reasonable and technically necessary, including but not limited to those identified in paragraph 3.4.1.4. of this Appendix.

3.4.1.4. The engine manufacturer shall specify for the service accumulation schedules any adjustment, cleaning, maintenance (where necessary) and scheduled exchange of the following items:

- filters and coolers in the exhaust gas re-circulation system
- positive crankcase ventilation valve, if applicable
- fuel injector tips (only cleaning is permitted)
- fuel injectors
- turbocharger
- electronic engine control unit and its associated sensors and actuators
- particulate after-treatment system (including related components)
- NO_x after-treatment system (including related components)
- exhaust gas re-circulation system, including all related control valves and tubing
- any other exhaust after-treatment system.

3.4.1.5. Scheduled critical emission-related maintenance shall only be performed if it is required to be performed in-use and that requirement is communicated to the end-user of the engine.

3.4.2. Changes to scheduled maintenance

The manufacturer shall submit a request to the Type Approval Authority for approval of any new scheduled maintenance that it wishes to perform during the service accumulation schedule and subsequently to recommend to end-users of engines. The request shall be accompanied by data supporting the need for the new scheduled maintenance and the maintenance interval.

3.4.3. Non-emission-related scheduled maintenance

Non-emission-related scheduled maintenance which is reasonable and technically necessary (for example oil change, oil filter change, fuel filter change, air filter change, cooling system maintenance, idle speed adjustment, governor, engine bolt torque, valve lash, injector lash, adjustment of the tension of any drive-belt, etc.) may be performed on engines selected for the service accumulation schedule at the least frequent intervals recommended by the manufacturer to the end-user (for example not at the intervals recommended for severe service).

3.5. Repair

3.5.1. Repairs to the components of an engine selected for testing over a service accumulation schedule shall be performed only as a result of component failure or engine malfunction. Repair of the engine itself, the emission control system or the fuel system is not permitted except to the extent defined in paragraph 3.5.2. of this Appendix.

3.5.2. If the engine, its emission control system (includes Oxidation catalyst, De-NO_x catalyst, particulate filters) or its fuel system fails during the service accumulation schedule, the service accumulation shall be considered void, and a new service accumulation shall be started with a new engine.

The previous paragraph shall not apply when the failed components are replaced with equivalent components that have been subject to a similar number of hours of service accumulation.

Appendix – 7

Procedure for the Measurement & calculation of Ammonia Emissions

1. **Ammonia measurement equipment** shall be as per the guideline given in the ISO-8178-1: 2017, 2020 Reciprocating internal combustion engines — Exhaust emission measurement — Part 1: Test-bed measurement systems of gaseous and particulate emission.
2. **Ammonia measurement procedure & calculation** shall be as per the guideline given in the ISO-8178-4: 2017, 2020 Reciprocating internal combustion engines — Exhaust emission measurement — Part 4: Steady-state and transient test cycles for different engine applications.

Appendix – 8

Method of test execution and measurement procedures. Procedure for developing the infrequent regeneration adjustment factor (IRAFs) for engine with exhaust after-treatment system

Method of test execution and measurement procedures shall be as per the guideline given in the ISO-8178-4: 2017, 2020 Reciprocating internal combustion engines — Exhaust emission measurement — Part 4: Steady-state and transient test cycles for different engine applications

Appendix – 9

Test Procedure for Emission measurement from Variable Speed Diesel Engines for Power generating set

Variable Speed Genset Engine

Normally all equipment operating at 30% below its maximum power uses a fictitious dummy load resistance to prevent damage; whereas these types of equipment can operate at 30% below its maximum power without any problem.

Variable speed hybrid generator sets that reduce fuel consumption by 40% compared to a standard generator set and 20% when compared with other fixed speed, hybrid Gensets currently available on the market and extend maintenance periods up to 1000 hours. These hybrid Gensets provide 48 DC for telecom applications. In addition, this equipment has a 230 AC auxiliary power output. No doubt, these type of Gensets are perfectly designed to meet the needs of the telecommunications sector, optimising resources, reducing consumption, ensuring an Eco-friendly system, extending maintenance periods, and lengthening the useful life of the product.

1.0 Introduction

In the present scenario of application of Diesel Genset Engines, the requirement of variable speed diesel genset is increasing where variable frequency of electricity is converted into constant frequency and better fuel economy is anticipated. Hence, a test procedure is required for emission compliance testing of variable speed diesel genset engines/Gensets.

2.0 Variable Speed Diesel Genset System Description

Variable speed diesel generating set consists of a variable speed diesel engine, axial flux Permanent Magnet Generator or Alternator (PMG or PMA) and power electronic converters. An electronic controller (DSP processor) controls output three phase sinusoidal voltage and adjusts engine speed according to actual load demand. For variable speed genset system, power electronic converters are used to convert variable-frequency variable voltage output to a constant voltage constant frequency output.

The block diagram of overall variable speed power generation system is shown in Figure 1 and Figure 2. A Permanent Magnet Generator or Alternator (PMG or PMA) is driven by a variable speed engine and it generates a variable frequency and variable amplitude AC voltage which is fed to power electronic converters (AC/AC converter, Rectifier, Inverter, Transformer etc.). The converter produces constant frequency three-phase sinusoidal constant voltage which is used for end load. Some part of this electricity is used as internal load to run engine fan, cooling motor, control panel etc. A system controller is used to control and monitor complete generating set. When no load is applied then the engine operates at a predefined minimum speed. When load increases then the controller runs the engine at an optimum speed to get best fuel consumption assuring a balance between power demand and power delivered by the engine.

The advantages of these sets over constant speed conventional generating set are mainly lighter in weight, smaller in size and enhanced fuel economy.

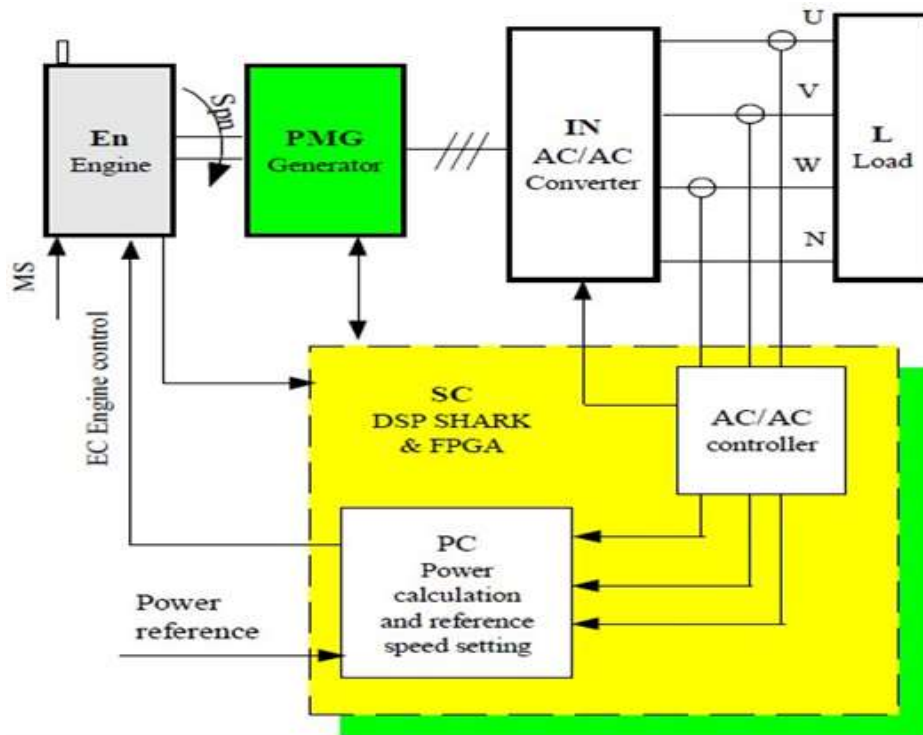

Figure 1. Block diagram of overall variable speed power generation system

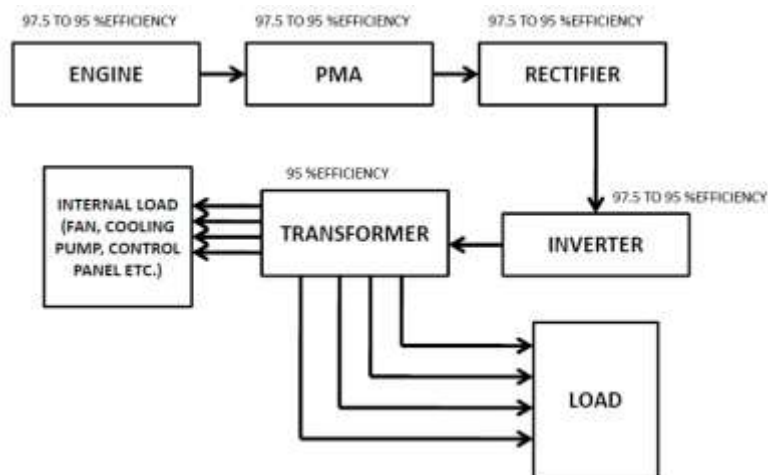

Figure 2. Block diagram of a variable speed diesel genset system

Test Cycle, Procedure & Equipment

3.1 The testing shall be done on engines with engine dynamometer. In case of import of complete genset, the engine shall be decoupled to test with engine dynamometer. The testing shall be done as per the following 5-mode cycle.

Test modes and weighting factors			
Mode No	Engine Speed	% Power	Weighting factor
1	Declared Speed (Rated speed)	100	0.05
2	Declared Speed	75	0.25
3	Declared Speed	50	0.30

4	Declared Speed	25	0.30
5	Declared Speed	10	0.10

3.2 The engine manufacturer shall declare rated speed, rated power, and part load speeds of the engine. The part loads shall be as mentioned in above table. The part load speeds shall be verified on actual working condition at manufacturer's place by Certification Agency before dismantling the set and submitting the engine for emission test. All the electronic equipment used for the measurement various testing shall be duly calibrated. The calibration requirement of the equipment other than mentioned in ISO 8178 -1 in this testing activity shall be as per IS 1248.2.2003 and IS 1248.4.

3.3 The engine shall be mounted on engine dynamometer and testing will be done as per the above cycle.

3.4 Testing shall be done with reference diesel fuel as per the specification given in annexure I of the main document. The fuel inlet temperature shall be maintained at 38±5 Deg C throughout the test.

3.5 Declared rated corrected Power

(i) For Type Approval:

- For single cylinder engines, ± 5% at rated & part load power points
- For all other engines, ± 4 % at rated & part load power points

(ii) For Conformity of Production:

- For single cylinder engines, at rated & part load power point, ± 6% of the type approved figure
- For all other engines, at rated & part load power point, ± 5% of the type approved figure

Declared rated and part load speeds shall vary within ± 1% 3.6 Calculation of gross mechanical power at rated speed

3.6 Calculation of gross mechanical power at rated speed

Manufacturer has to declare the gross mechanical power and final electrical power (kVA rating) for testing the engine on test bench considering the losses at all stages up to final output. Losses at PMG/PMA, Rectifier, Inverter, Transformer + Internal load if any (Fan, Cooling pump, control panel) etc. to be considered

Total Efficiency = Efficiency of PMA/PMG x Efficiency of Rectifier x Efficiency of Inverter x Efficiency of Transformer x Efficiency of any other power electronic converters

Gross mechanical power in kW = (kVA x PF) / (Total Efficiency) + (Internal Load in kW) / (Total Efficiency)

Where,

kVA = Electrical power output

PF = Power Factor

Electrical Power output, at all declared speed and load conditions of the variable speed generator set with all necessary power electronic converters will be verified on actual working condition at manufacturer's place by certification agency. Manufacturers shall submit supporting documents (duly certified and attested by the manufacturer/supplier) for efficiencies of various power electronic converters connected in the line starting from engine end upto final output. This data is required to calculate the gross mechanical power of the engine to be set for emission test on test bench.

The actual electrical power output at all the test points shall be verified at manufacturer's place should be within ± 5 % (for single cylinder engines) or ± 4 % (for all other engines) of the declared electrical power (kVA rating).

Example:

Electrical power output at rated speed = 50 kVA

Efficiencies:

Efficiency of PMA = 0.97

Efficiency of Invertor = 0.95

Efficiency of Transformer = 0.96

Total Efficiency = 0.97 x 0.95 x 0.96 = 0.885

Power Factor (PF) = 0.95

Internal Load in kW:

Fan, Cooling pump, control panel = 5 kW

Gross mechanical power in kW = $(50 \times 0.95)/0.885 + 5/0.885 = 59.3$ kW

Manufacturer has to declare gross mechanical power in such a way that both “gross mechanical power in kW as observed on the engine test bench” and “calculated gross mechanical power (calculated by efficiencies applied to the observed electrical power at rated speed as declared by the manufacturer)” should remain within $\pm 5\%$ (for single cylinder engines) or $\pm 4\%$ (for all other engines) of the declared gross mechanical power.

- 3.7 Test Equipment, setup, procedure, calculation method and other relevant technical details to be used shall be as mentioned in the main document “SYSTEM & PROCEDURE FOR COMPLIANCE TO EMISSION LIMITS FOR NEW DIESEL ENGINES (UP TO 800 KW) FOR GENSET APPLICATIONS”, except where it is mentioned, specifically, in this document.

Note: As the number of variable speeds generating set engines in the field are very few, the document, test cycle and the test procedure for these engines is prepared based on the actual usage pattern conditions on the set in the site with a limited data availability. Hence this document, test cycle and test procedure shall be reviewed and revised if found necessary based on the testing experience.

ANNEXURE – 8

Requirements regarding emission control strategies, NO_x control measures and particulate control measures

1. Definitions abbreviations and general requirements

1.1. For the purposes of this Annex, the following definitions and abbreviations apply:

- (a) "diagnostic trouble code ("DTC")" means a numeric or alphanumeric identifier which identifies or labels a NCM and/ PCM;
- (b) "confirmed and active DTC" means a DTC that is stored during the time the NCD and/or PCD system concludes that a malfunction exists;
- (c) "NCD engine family" "means a manufacturer's grouping of engines having common methods of monitoring/diagnosing NCMs
- (d) "NO_x Control Diagnostic system (NCD)" means a system on-board the engine/control room which has the capability of
 - (i) detecting a NO_x Control Malfunction,
 - (ii) identifying the likely cause of NO_x control malfunctions by means of information stored in computer memory and/or communicating that information off-board;
- (e) "NO_x Control Malfunction (NCM)" means an attempt to tamper with the NO_x control system of an engine or a malfunction affecting that system that might be due to tampering, that is considered by this Regulation as requiring the activation of a warning or an inducement system once detected;
- (f) "Particulate Control Diagnostic system (PCD)" means a system on-board the engine/control room which has a capability of:
 - (i) detecting a Particulate Control Malfunction,
 - (ii) identifying the likely cause of particulate control malfunctions by means of information stored in computer memory and/or communicating that information off-board;
- (g) "Particulate Control Malfunction (PCM)" means an attempt to tamper with the particulate after-treatment system of an engine or a malfunction affecting the particulate after-treatment system that might be due to tampering, that is considered by this Regulation as requiring the activation of a warning once detected;
- (h) "PCD engine family" means a manufacturer's grouping of engines having common methods of monitoring/diagnosing PCMs;
- (i) "Scan-tool" means an external test equipment used for off-board communication with the NCD and/or PCD system.

1.2. Ambient temperature

Where reference is made to ambient temperature in relation to environments other than a laboratory environment, the following provisions shall apply:

1.2.1 For an engine installed in a test-bed, ambient temperature shall be the temperature of the combustion air supplied to the engine, upstream of any part of the engine being tested.

1.2.2 For an engine installed in Genset, ambient temperature shall be the air temperature immediately outside the perimeter of the Genset. Manufacture may opt to consider temperature inside genset enclosure as an ambient temperature for certain diagnostics in consultation with type approval agency and using sound Engineering judgement.

2. Technical requirements relating to emission control strategies

- 2.1. This paragraph 2. shall apply for electronically controlled genset engines of all powered category complying with the emission limits set out in clause 3 of this Regulation and using electronic control to determine both the quantity and timing of injecting fuel or using electronic control to activate, de-activate or modulate the emission control system used to reduce NO_x.
- 2.2. Requirements for base emission control strategy
 - 2.2.1 The base emission control strategy shall be designed as to enable the engine, in normal use, to comply with the provisions of this Regulation. Normal use is not restricted to the control conditions as specified in paragraph 2.4.
 - 2.2.2. Base emission control strategies are, but not limited to, maps or algorithms for controlling:
 - (a) timing of fuel injection or ignition (engine timing);
 - (b) exhaust gas recirculation (EGR);
 - (c) SCR catalyst reagent dosing.
 - 2.2.3. Any base emission control strategy that can distinguish engine operation between a standardised approval test and other operating conditions and subsequently reduce the level of emission control when not operating under conditions substantially included in the approval procedure is prohibited.
 - 2.2.3.1. Reserved
 - 2.2.4 The manufacturer shall demonstrate to the technical agency at the time of the type-approval test that the operation of the base emission control strategy complies with the provisions of this section. The demonstration shall consist of an evaluation of the documentation referred to in paragraph 2.6. of this Annex. The manufacturer shall comply with the documentation requirements laid down in paragraph 1.4. of Annex 1 and Appendix A.2 to that Annex.
- 2.3. Requirements for auxiliary emission control strategy.
 - 2.3.1 An auxiliary emission control strategy may be activated by an engine or Genset, provided that the auxiliary emission control strategy:
 - 2.3.1.1. does not permanently reduce the effectiveness of the emission control system;
 - 2.3.1.2. operates only outside the control conditions specified in paragraphs 2.4.3. of this Annex for the purposes defined in paragraph 2.3.5. of this Annex and only as long as is needed for those purposes, except as permitted by paragraphs 2.3.1.3., 2.3.2. and 2.3.4. of this Annex;
 - 2.3.1.3. is activated only exceptionally within the control conditions in paragraphs 2.4.3. of this Annex, respectively, has been demonstrated to be necessary for the purposes identified in paragraph 2.3.5. of this Annex has been approved by the Type Approval Authority, and is not activated for longer than is needed for those purposes;
 - 2.3.1.4. ensures a level of performance of the emission control system that is as close as possible to that provided by the base emission control strategy;
 - 2.3.2. Where the auxiliary emission control strategy is activated during the type-approval test, activation shall not be limited to occur outside the control conditions set out in paragraph 2.4. of this Annex, and the purpose shall not be limited to the criteria set out in paragraph 2.3.5. of this Annex.
 - 2.3.3. Where the auxiliary emission control strategy is not activated during the type-approval test, it must be demonstrated that the auxiliary emission control strategy is active only for as long as required for the purposes set out in paragraph 2.3.5. of this Annex.
 - 2.3.4. Cold temperature operation.

An auxiliary emission control strategy may be activated on an engine equipped with exhaust gas recirculation (EGR) irrespective of the control conditions in paragraph 2.4. of this Annex if the ambient temperature is below 275 K (2 °C) and one of the two following criteria is met:

- (a) intake manifold temperature is less than or equal to the temperature defined by the following equation: $IMT_c = P_{IM} / 15.75 + 304.4$, where: IMT_c is the calculated intake manifold temperature, K and P_{IM} is the absolute intake manifold pressure in kPa;
- (b) engine coolant temperature is less than or equal to the temperature defined by the following equation: $ECT_c = P_{IM} / 14.004 + 325.8$, where: ECT_c is the calculated engine coolant temperature, K and P_{IM} is the absolute intake manifold pressure, kPa.

2.3.5. Except as permitted by paragraph 2.3.2. of this Annex, an auxiliary emission control strategy may solely be activated for the following purposes:

- (a) by on-board signals, for protecting the engine (including air-handling device protection) and/or Genset into which the engine is installed from damage;
- (b) for operational safety reasons;
- (c) for prevention of excessive emissions, during cold start or warming-up, during shut-down;
- (d) if used to trade-off the control of one regulated pollutant under specific ambient or operating conditions, for maintaining control of all other regulated pollutants, within the emission limit values that are appropriate for the engine concerned. The purpose is to compensate for naturally occurring phenomena in a manner that provides acceptable control of all emission constituents.

2.3.6. The manufacturer shall demonstrate to the technical agency at the time of the type-approval test that the operation of any auxiliary emission strategy complies with the provisions of this paragraph. The demonstration shall consist of an evaluation of the documentation referred to in paragraph 2.6. of this Annex.

2.3.7. Any operation of an auxiliary emission control strategy non-compliant with paragraphs 2.3.1. to 2.3.5. of this Annex is prohibited.

2.4. Control conditions

The control conditions specify an altitude, ambient temperature and engine coolant range that determines whether auxiliary emission control strategies may generally or only exceptionally be activated in accordance with paragraph 2.3. of this Annex.

The control conditions specify an atmospheric pressure which is measured as absolute atmospheric static pressure (wet or dry) ("Atmospheric pressure")

2.4.1. Reserved

2.4.2. Reserved

2.4.3. Control conditions for engines of power bands $56 \leq P < 800$ kW

- (a) the atmospheric pressure greater than or equal to 82,5 kPa;
- (b) the ambient temperature within the following range:
 - (i) equal to or above 273K (0 °C)
 - (ii) less than or equal to the temperature determined by the following equation at the specified atmospheric pressure: $T_c = -0.4514 \cdot (101.3 - P_b) + 311$, where: T_c is the calculated ambient air temperature, K and P_b is the atmospheric pressure, kPa; (With Ambient pressure P_b 100kPa, $T_c=38.58$ °C and P_b 82.5kPa, Altitude at 1700 meter /5500 feet, $T_c=46.5$ °C)
- (c) the engine coolant temperature above 343 K (70 °C).

Where the auxiliary emission control strategy is activated when the engine is operating within the control conditions set out in points (i), (ii) and (c), the strategy shall only be

activated when demonstrated to be necessary for the purposes identified in clause 5.3.2.2.3. below and approved by the Test Agency.

- 2.5. Where the engine inlet air temperature sensor is being used to estimate ambient air temperature the nominal offset between the two measurement points shall be evaluated for an engine type or engine family. Where used, the measured intake air temperature shall be adjusted by an amount equal to the nominal offset to estimate ambient temperature for an installation using the specified engine type or engine family.

The evaluation of the offset shall be made using good engineering judgement based on technical elements (calculations, simulations, experimental results, data etc.) including:

- (a) the typical Genset enclosures into which the engine type or engine family will be installed; and,
- (b) the installation instructions provided to the OEM by the manufacturer.

A copy of the evaluation shall be made available to the Type Approval Authority upon request.

2.6. Documentation requirements

- 2.6.1 The manufacturer shall comply with the documentation requirements laid down in Annexure 1
- 2.6.2 The manufacturer shall ensure all documents used for this purpose are marked with an identification number and date. Whenever particulars recorded are changed the relevant pages shall be marked to clearly show the date of revision and the nature of the amendment. A consolidated, updated version, accompanied by a detailed description of the amendments, shall be deemed to fulfil the requirement of this paragraph. /Clause

3. Technical requirements relating to NO_x control measures

- 3.1. Clause 3. of this Annex shall apply to electronically controlled engines complying with the emission limits set out in clause 3 of this Regulation and using electronic control to determine both the quantity and timing of injecting fuel or using electronic control to activate, de-activate or modulate the emission control system used to reduce NO_x.
- 3.2. The manufacturer shall provide complete information on the functional operational characteristics of the NO_x control measures using the documents set out in Annexure 1.
- 3.3. The NO_x control strategy shall be operational under all environmental conditions regularly occurring in India especially at low ambient temperatures.
- 3.4. The manufacturer shall demonstrate that the emission of ammonia during the applicable emission test cycle of the type approval procedure, when a reagent is used, does not exceed a mean value of 10 ppm for >56 kW & 25 ppm for <56 kW engine categories.
- 3.5. For reagent containers installed on a genset/engine, means for taking a sample of the reagent inside the containers must be included. The sampling point must be easily accessible without requiring the use of any specialised tool or device.
- 3.6. In addition to the requirements set out in clauses 3.2. to 3.5. of this Annex, the technical requirements set out in Appendix A.1 of this Annex shall apply for engines.

4. Technical requirements relating to particulate pollutant control measures.

- 4.1. This paragraph shall apply to engines of sub-categories subject to meet particulate emission limits in accordance with the emission limits set out in clause 3 of this Regulation fitted with a particulate after-treatment system. In cases where the NO_x control system and the particulate control system share the same physical components (e.g. same substrate (SCR on filter), same exhaust temperature sensor) the requirements of this paragraph shall not apply to any component or malfunction where, after consideration of a reasoned assessment provided by the manufacturer, the Type Approval Authority concludes that a particulate control malfunction within the scope of this paragraph would lead to a corresponding NO_x control malfunction within the scope of paragraph 3. of this Annexure.
- 4.2. The detailed technical requirements relating to particulate pollutant control measures are specified in Appendix A.2 of this Annex

Appendix – A.1

Additional technical requirements on NO_x control measures for engines, including the method to demonstrate these strategies

A.1.1. Introduction

This Appendix sets out the additional requirements to ensure the correct operation of NO_x control measures. It includes requirements for engines that rely on the use of a reagent in order to reduce emissions. The type approval shall be made conditional upon the application of the relevant provisions on engine/genset operator or genset control room instruction, installation documents, operator warning system, inducement system and reagent freeze protection that are set out in this Appendix.

A.1.2. General requirements

The engine shall be equipped with a NO_x Control Diagnostic system (NCD) able to identify the NO_x control malfunctions (NCMs). Any engine covered by this paragraph shall be designed, constructed and installed so as to be capable of meeting these requirements throughout the normal life of the engine under normal conditions of use. In achieving this objective, it is acceptable that engines which have been used in excess of the emission durability period as specified in Appendix 6 to Annexure 7 of this Regulation show some deterioration in the performance and the sensitivity of the NO_x Control Diagnostic system (NCD), such that the thresholds specified in this Annexure may be exceeded before the warning and/or inducement systems are activated.

- A.1.2.1. Required information
 - A.1.2.1.1. If the emission control system requires a reagent, the type of reagent, information on concentration when the reagent is in solution, its operational temperature conditions a reference to international standards for composition and quality and other characteristics of that reagent shall be specified by the manufacturer in accordance with Appendix A.3 of Annexure 1.
 - A.1.2.1.2. Detailed written information fully describing the functional operation characteristics of the engine or genset operator/genset control room warning system set out in paragraph A.1.4. of this Annexure and of the operator inducement system set out in paragraph A.1.5. of this Annexure shall be provided to the Type Approval Authority at the time of approval.
 - A.1.2.1.3. The manufacturer shall provide the OEM with documents with instructions on how to install the engine in the Genset in such manner that the engine, its emission control system and the Genset parts, operate in conformity with the requirements of this Appendix. This documentation shall include the detailed technical requirements of the engine (software, hardware, and communication) needed for the correct installation of the engine in the Genset application.
- A.1.2.2. Operating conditions
 - A.1.2.2.1. Monitoring for reagent level in the storage tank shall be conducted under all conditions where measurement is technically feasible (for instance, under all conditions when a liquid reagent is not frozen).
 - A.1.2.2.2. Reagent freeze protection shall apply at ambient temperatures at or below 273K (0 °C).
 - A.1.2.2.3. All elements of the NO_x control diagnostic system other than those listed in paragraphs A.1.2.2.1. and A.1.2.2.2. of this Annexure shall, at a minimum be operational at the applicable control conditions set out in paragraph 2.4 of this Annexure for each engine category. The diagnostic system shall remain operational outside of this range where technically possible.
- A.1.2.3. Reagent freeze protection

- A.1.2.3.1. It is permitted to use a heated or a non-heated reagent tank and dosing system. A heated system shall meet the requirements of paragraph A.1.2.3.2.2. of this Annexure. A non-heated system shall meet the requirements of paragraph A.1.2.3.2.3. of this Annexure.
- A.1.2.3.1.1. The use of a non-heated reagent tank and dosing system shall be indicated in the written instructions to the end-user of the Genset.
- A.1.2.3.2. Reagent tank and dosing system
- A.1.2.3.2.1. If the reagent has frozen, the reagent shall be available for use within a maximum of 70 minutes after the start of the engine at or above 273 K (0 °C) ambient temperature.
- A.1.2.3.2.2. Design criteria for a heated system
- A heated system shall be so designed that it meets the performance requirements set out in this paragraph A.1.2.3.2. when tested using the procedure defined.
- Demonstration test at the time of type approval is not mandatory.
- A.1.2.3.2.2.1. The reagent tank and dosing system shall be soaked at 255 K (- 18°C) for 72 hours or until the reagent becomes solid, whichever occurs first.
- A.1.2.3.2.2.2. After the soak period set out in paragraph A.1.2.3.2.2.1. of this Annexure, the Genset engine shall be started and operated at 266 K (- 7 °C) ambient temperature or lower as follows:
- (a) 10 to 20 minutes idling, followed by
- (b) up to 50 minutes at no more than 40 per cent of rated torque.
- A.1.2.3.2.2.3. At the conclusion of the test procedure set out in paragraph A.1.2.3.2.2.2. of this Annexure, the reagent dosing system shall be fully functional.
- A.1.2.3.2.2.4. Evaluation of the design criteria may be performed in a cold chamber test cell using an entire Genset or parts representative of those to be installed on such machinery or based on field tests.
- A.1.2.3.2.3. Activation of the operator warning and inducement system for a non-heated system
- A.1.2.3.2.3.1. The operator warning system described in paragraph A1.4 of this Annexure shall be activated if no reagent dosing occurs at an ambient temperature ≥ 273 K (0°C).
- A.1.2.3.2.3.2. The Operator inducement system described in paragraph A1.5. of this Annexure shall be activated if no reagent dosing occurs within a maximum of 70 minutes after engine start at an ambient temperature ≥ 273 K (0°C).
- A.1.2.4. Diagnostic requirements
- A.1.2.4.1. The NO_x Control Diagnostic system (NCD) shall be able to identify the NO_x control malfunctions (NCMs) by means of Diagnostic Trouble Codes (DTCs) stored in the computer memory and to communicate that information off-board upon request.
- A.1.2.4.2. Requirements for recording Diagnostic Trouble Codes (DTCs)
- A.1.2.4.2.1. The NCD system shall record a DTC for each distinct NO_x Control Malfunction (NCM).
- A.1.2.4.2.2. The NCD system shall conclude within 60 minutes of engine operation whether a detectable malfunction is present. At this time, a "confirmed and active" DTC shall be stored and the warning system be activated according to paragraph A.1.4. of this Annex.
- A.1.2.4.2.3. In cases where more than 60 minutes running time is required for the monitors to accurately detect and confirm a NCM (e.g. monitors using statistical models or with respect to fluid consumption on the Genset), the Type Approval Authority may permit a longer period for monitoring provided the manufacturer justifies the need for the longer period (for example by technical rationale, experimental results, in house experience, etc.).
- A.1.2.4.3. Requirements for erasing Diagnostic trouble codes (DTCs)

- (a) DTCs shall not be erased by the NCD system itself from the computer memory until the failure related to that DTC has been remedied.
 - (b) The NCD system may erase all the DTCs upon request of a proprietary scan or maintenance tool that is provided by the engine manufacturer upon request, or using a pass code provided by the engine manufacturer.
- A.1.2.4.4. An NCD system shall not be programmed or otherwise designed to deactivate partially or totally based on age of Genset during the actual life of the engine, nor shall the system contain any algorithm or strategy designed to reduce the effectiveness of the NCD system over time.
- A.1.2.4.5. Any reprogrammable computer codes or operating parameters of the NCD system shall be resistant to tampering.
- A.1.2.4.6. NCD engine family
- The manufacturer is responsible for determining the composition of an NCD engine family. Grouping engines within an NCD engine family shall be based on good engineering judgment and be subject to approval by the Type Approval Authority.
- Engines that do not belong to the same engine family may still belong to the same NCD engine family.
- A.1.2.4.6.1. Parameters defining an NCD engine family
- An NCD engine family is characterized by basic design parameters that shall be common to engines within the family.
- In order that engines are considered to belong to the same NCD engine family, the following list of basic parameters shall be similar:
- (a) emission control systems;
 - (b) methods of NCD monitoring;
 - (c) criteria for NCD monitoring;
 - (d) monitoring parameters (e.g. frequency).
- These similarities shall be demonstrated by the manufacturer by means of relevant engineering demonstration or other appropriate procedures and subject to the approval of the Type Approval Authority.
- The manufacturer may request approval by the Type Approval Authority of minor differences in the methods of monitoring/diagnosing the NCD system due to engine configuration variation, when these methods are considered similar by the manufacturer and they differ only in order to match specific characteristics of the components under consideration (for example size, exhaust gas flow, etc.); or their similarities are based on good engineering judgment.
- A.1.3. Maintenance requirements**
- A.1.3.1. The OEM shall provide to all end-users of genset written instructions about the emission control system and its correct operation in accordance with Appendix 2 of Annexure 9.
- A.1.4. Operator or control room warning system**
- A.1.4.1. The genset shall include an operator or control room warning system using visual and audible component that informs the operator when a low reagent level, incorrect reagent quality, interruption of dosing or a malfunction specified in clause A.1.9. of this Annexure has been detected that will lead to activation of the operator inducement system if not rectified in a timely manner. The warning system shall remain active when the operator inducement system described in paragraph A.1.5. of this Annexure has been activated.

- A.1.4.2. The warning shall not be the same as the warning used for the purposes of malfunction or other engine maintenance, though it may use the same warning system.
- A.1.4.3. The operator warning system may consist of one or more lamps, or display short messages, which may include, for example, messages indicating clearly:
- (a) the remaining time before activation of the low-level and / or severe inducements,
 - (b) the amount of low-level and / or severe inducement, for example the amount of torque reduction or effective disablement of operation.,
 - (c) the conditions under which Genset disablement can be cleared.
- Where messages are displayed, the system used for displaying these messages may be the same as the one used for other maintenance purposes.
- A.1.4.4. The warning system shall include an audible component to alert the operator in line with A.1.14 of this Annexure. The cancelling of audible warnings by the operator shall be permitted. An audible alarm system must be activated at minimum when the operator inducement system described in paragraph A.1.5. of this Annexure has been activated.
- A.1.4.5. The operator warning system shall be activated as specified in paragraphs A.1.2.3.2.3.1., A.1.6.2., A.1.7.2., A.1.8.3., and A.1.9.3. of this Annexure respectively.
- A.1.4.6. The operator warning system shall be deactivated when the conditions for its activation have ceased to exist. The operator warning system shall not be automatically deactivated without the reason for its activation having been remedied.
- A.1.4.7. The warning system may be temporarily interrupted by other warning signals providing important safety related messages.
- A.1.4.8. Details of the operator warning system activation and deactivation procedures are described in paragraph A.1.11. of this Annexure.
- A.1.4.9. As part of the application for approval under this Regulation, the manufacturer shall demonstrate the operation of the operator warning system, as specified in paragraph A.1.10. of this Annexure.

A.1.5. Operator inducement system

- A.1.5.1. The engine shall incorporate an operator inducement system based on one of the following principles:
- A.1.5.1.1. a two-stage inducement system starting with a low-level inducement Audio-Visual Alarm followed by a severe inducement (effective disablement of Genset operation);
 - A.1.5.1.2. a one-stage severe inducement system (effective disablement of Genset operation) activated under the conditions of a low-level inducement system as specified in paragraphs A.1.6.3.1., A.1.7.3.1., A.1.8.4.1., and A.1.9.4.1. of this Annexure.
- Where the manufacturer elects to shut down the engine to fulfil the requirement for one-stage severe inducement then the inducement for reagent level may, at the choice of the manufacturer, be activated under the conditions of paragraph A.1.6.3.2. of this Annexure instead of the conditions of paragraph A.1.6.3.1. of this Annexure.
- A.1.5.2. Reserved
 - A.1.5.3. Low-level inducement system
 - A.1.5.3.1. The low-level inducement system shall be activated after any of the conditions specified in paragraphs A.1.6.3.1., A.1.7.3.1., A.1.8.4.1., and A.1.9.4.1. of this Annexure has occurred.
 - A.1.5.3.2. For variable speed genset engines, the low-level inducement system shall the Audio-Visual Alarm
 - A.1.5.3.3. For constant speed engines, low level inducement shall the Audio-Visual Alarm
 - A.1.5.3.4. Other inducement measures that are demonstrated to the Type Approval Authority as having the same or greater level of severity may be used.

- A.1.5.4. Severe inducement system
- A.1.5.4.1. The severe inducement system shall be activated after any of the conditions specified in paragraphs A.1.2.3.2.3.2., A.1.6.3.2., A.1.7.3.2., A.1.8.4.2., and A.1.9.4.2. of this Annexure has occurred.
- A.1.5.4.2. The severe inducement system shall effectively disable Genset operation to cause the operator to remedy any problems related to paragraphs A.1.6. to A.1.9. of this Annexure. The following strategy shall be applied:
- (a) Strategy A:**
- An audio/visual warning and a grace period of 72 hours after which the severe inducement will effectively disable Genset operation to cause the operator to remedy any problems related to paragraphs A.1.6. to A.1.9. of this Annexure. (To mention no torque de-rate with this severe inducement strategy)
- (b) Strategy B:**
- An audio/visual warning with a torque de-rate of minimum 50% and a grace period of 120 hours after which the severe inducement will effectively disable Genset operation to cause the operator to remedy any problems related to paragraphs A.1.6. to A.1.9. of this Annexure.
- A.1.5.4.2.1. Genset engines, torque between the peak torque speed and the governor breakpoint shall be gradually reduce to zero torque and Minimum speed of 1 per cent per minute to zero percent of maximum torque within same time to speed reduction to Minimum speed and for variable speed engines the engine speed shall be gradually reduced to Minimum speed within the same time as the torque reduction.
- Genset with severe-inducement condition activated when shut down; shall not start in next attempt barring activation of operator overrides described in paragraph A.1.5.5. of this annexure.
- A.1.5.4.2.2. Manufacturer may have option for direct disablement of engine after key off without going to torque / torque and speed de-rate schedule for severe level inducement as described in paragraph A.1.5.4.2.1 of this Annexure.
- A.1.5.4.2.3. Other inducement measures that are demonstrated to the Type Approval Authority as having the same or greater level of severity may be used.
- A.1.5.5. In order to account for safety concerns and to allow for self-healing diagnostics, use of an inducement override function for releasing full engine power is permitted provided it
- (a) is limited to 3 activations during each activation period that the operator inducement system is active and
- (b) each activation period is limited to 30 minutes
- A.1.5.6. The operator inducement system shall be deactivated when the conditions for its activation have ceased to exist. The operator inducement system shall not be automatically deactivated without the reason for its activation having been remedied.
- A.1.5.7. Details of the operator inducement system activation and deactivation procedures are described in paragraph A.1.11. of this Annexure.
- A.1.5.8. As part of the application for approval under this Regulation, the manufacturer shall demonstrate the operation of the operator inducement system, as specified in clause A.1.10. of this Annexure.
- A.1.6. Reagent Availability**
- A.1.6.1. Reagent level indicator
- The genset/engine shall include an indicator that clearly informs the operator /control room of the level of reagent in the reagent storage tank. The minimum acceptable performance level for the reagent indicator is that it shall continuously indicate the reagent level whilst the operator warning system referred to in paragraph A.1.4. of this

Annexure is activated. The reagent indicator may be in the form of an analogue or digital display, and may show the level as a proportion of the full tank capacity, the amount of remaining reagent, or the estimated operating hours remaining

Additionally, remote information and monitoring system described in Appendix 4 of this Annexure where applicable shall provide with reagent level information at least when operator warning system referred to in paragraph A.1.4. of this Annexure is activated.

- A.1.6.2. Activation of the operator warning system
 - A.1.6.2.1. The operator warning system specified in paragraph A.1.4. of this Annexure shall be activated when the level of reagent goes below 10 per cent of the capacity of the reagent tank or a higher percentage at the choice of the manufacturer.
 - A.1.6.2.2. The warning provided shall be sufficiently clear, in conjunction with the reagent indicator, for the operator to understand that the reagent level is low. When the warning system includes a message display system, the visual warning shall display a message indicating a low level of reagent. (for example, "urea level low", "AdBlue level low", or "reagent low").
 - A.1.6.2.3. The operator warning system does not initially need to be continuously activated (for example a message does not need to be continuously displayed), however activation shall escalate in intensity so that it becomes continuous as the level of the reagent approaches empty and the point where the operator inducement system will come into effect is approached (for example frequency at which a lamp flashes). It shall culminate in an operator notification at a level that is at the choice of the manufacturer, but sufficiently more noticeable at the point where the operator inducement system in paragraph A.1.6.3. of this Annexure comes into effect than when it was first activated.
 - A.1.6.2.4. The continuous warning shall not be easily disabled or ignored. When the warning system includes a message display system, an explicit message shall be displayed (for example "fill up urea", "fill up AdBlue", or "fill up reagent"). The continuous warning may be temporarily interrupted by other warning signals providing important safety related messages.
 - A.1.6.2.5. It shall not be possible to turn off the operating warning system until the reagent has been replenished to a level not requiring its activation.
 - A.1.6.2.6. Additionally, audio warning system described in paragraph A.1.14 of this Annexure shall become active when the level of reagent goes below 10 per cent of the capacity of the reagent tank or at a percentage operator warning system is activated at the choice of the manufacturer.
- A.1.6.3 Activation of the operator inducement system
 - A.1.6.3.1 The low-level inducement system described in paragraph A.1.5.3. of this Annexure shall be activated if the reagent tank level goes below 2.5 per cent of its nominally full capacity or a higher percentage at the choice of the manufacturer.
 - A.1.6.3.2. The severe inducement system described in paragraph A.1.5.4. of this Annexure shall be activated if the reagent tank is empty, that is, when the dosing system is unable to draw further reagent from the tank, or at any level below 2.5 per cent of its nominally full capacity at the discretion of the manufacturer.
 - A.1.6.3.3. Except to the extent permitted by paragraph A.1.5.5. of this Annexure, it shall not be possible to turn off the low-level or severe inducement system until the reagent has been replenished to a level not requiring their respective activation.

A.1.7. Reagent Quality Monitoring

- A.1.7.1. The engine, or Genset shall include a means of determining the presence of an incorrect reagent on board.
 - A.1.7.1.1. The manufacturer shall specify a minimum acceptable reagent concentration CD_{min} , which results in tailpipe NO_x emissions not exceeding the lower of either the applicable NO_x limit multiplied by 2.25 or the applicable NO_x limit plus 1.5 g/kWh. For engine sub-categories with a combined HC and NO_x limit, the applicable NO_x limit value for the

purpose of this paragraph shall be the combined limit value for HC and NO_x reduced by 0.19 g/kWh.

- A.1.7.1.1.1. The value of CD_{min} specified by the manufacturer shall be used during the demonstration set out in paragraph A.1.13. of this Annexure and recorded in the extended documentation package as specified in Appendix A.3 to Annex 1.
- A.1.7.1.2. Any reagent concentration lower than CD_{min} shall be detected and be regarded, for the purpose of paragraph A.1.7.1. of this Annexure, as being incorrect reagent.
- A.1.7.1.3. A specific counter ("the reagent quality counter") shall be attributed to the reagent quality. The reagent quality counter shall count the number of engine operating hours with an incorrect reagent.
- A.1.7.1.3.1. Optionally, the manufacturer may group the reagent quality failure together with one or more of the failures listed in paragraphs A.1.8. of this Annexure and A.1.9. of this Annexure into a single counter.
- A.1.7.1.4. Details of the reagent quality counter activation and deactivation criteria and mechanisms are described in paragraph A.1.11. of this Annexure.
- A.1.7.2. Activation of the operator warning system
When the monitoring system confirms that the reagent quality is incorrect, the operator warning system described in paragraph 1.4 shall be activated. When the warning system includes a message display system, it shall display a message indicating the reason of the warning (for example "incorrect urea detected", "incorrect AdBlue detected", or "incorrect reagent detected").
- A.1.7.3 Activation of the operator inducement system
- A.1.7.3.1. The low-level inducement system described in paragraph A.1.5.3. of this Annexure shall be activated if the reagent quality is not rectified within a maximum of 36 engine operating hours after the activation of the operator warning system as described in paragraph A.1.7.2. of this Annexure.
- A.1.7.3.2. The severe inducement system described in paragraph A.1.5.4. of this Annexure shall be activated if their emission performance does not require reagent dosing. The severe inducement system described in clause A.1.5.4. of this Appendix shall be activated if the reagent quality is not rectified within a maximum of 72 engine operating hours after the activation of the operator warning system as described in clause A.1.7.2. of this Appendix.
- A.1.7.3.3. The number of hours prior to activation of the inducement systems shall be reduced in case of a repetitive occurrence of the malfunction according to the mechanism described in clause A.1.11. of this Appendix.
- A.1.8. Reagent Dosing Activity
- A.1.8.1 The engine shall include a means of determining interruption of dosing.
- A.1.8.2. Reagent dosing activity counter
- A.1.8.2.1. A specific counter shall be attributed to the dosing activity (the "dosing activity counter"). The counter shall count the number of engine operating hours which occur with an interruption of the reagent dosing activity. This is not required where such interruption is demanded by the engine ECU because the Genset operating conditions are such that their emission performance does not required reagent dosing.
- A.1.8.2.1.1. Optionally, the manufacturer may group the reagent dosing failure together with one or more of the failures listed in paragraphs A.1.7. and A.1.9. of this Annexure into a single counter.
- A.1.8.2.2. Details of the reagent dosing activity counter activation and deactivation criteria and mechanisms are described in paragraph A.1.11. of this Annexure.
- A.1.8.3. Activation of the operator warning system

The operator warning system described in paragraph A.1.4. of this Annexure shall be activated in the case of interruption of dosing which sets the dosing activity counter in accordance with paragraph A.1.8.2.1. of this Annexure. When the warning system includes a message display system, it shall display a message indicating the reason of the warning (e.g. "urea dosing malfunction", "AdBlue dosing malfunction", or "reagent dosing malfunction").

A.1.8.4. Activation of the operator inducement system

A.1.8.4.1. The low-level inducement system described in paragraph A.1.5.3. of this Annexure shall be activated if an interruption in reagent dosing is not rectified within a maximum of 36 engine operating hours after the activation of the operator warning system in accordance with paragraph A.1.8.3. of this Annexure.

A.1.8.4.2. The severe inducement system described in paragraph A.1.5.4. of this Annexure shall be activated if an interruption in reagent dosing is not rectified within a maximum of **72** engine operating hours after the activation of the operator warning system in accordance with paragraph A.1.8.3. of this Annexure.

A.1.8.4.3. The number of hours prior to activation of the inducement systems shall be reduced in case of a repetitive occurrence of the malfunction according to the mechanism described in paragraph A.1.11. of this Annexure.

A.1.9. Other failures that may be attributed to tampering

A.1.9.1. In addition to the level of reagent in the reagent tank, the reagent quality, and the interruption of dosing, the following failures shall be monitored because they may be attributed to tampering:

(a) failures of the NO_x Control Diagnostic (NCD) system as described in paragraph A.1.9.2.1. of this Annexure;

(b) failures of the exhaust gas recirculation (EGR) valve as described in paragraph A.1.9.2.2. of this Annexure;

A.1.9.2. Monitoring requirements and counters

A.1.9.2.1. NCD system

A.1.9.2.1.1. The NO_x Control Diagnostic (NCD) system shall be monitored for electrical failures and for removal or deactivation of any sensor that prevents it from diagnosing any other failures set out in paragraphs A.1.6. to A.1.8. (component monitoring) of this Annexure.

A non-exhaustive list of sensors that affect the diagnostic capability are those directly measuring NO_x concentration, urea quality sensors, ambient sensors and sensors used for monitoring reagent dosing activity, reagent level or reagent consumption.

A.1.9.2.1.2. A counter shall be attributed to each of the monitoring failures. The NCD system counters shall count the number of engine operating hours when the DTC associated to a malfunction of the NCD system is confirmed to be active. Different NCD system failures may be grouped into a single counter.

A.1.9.2.1.2.1. The manufacturer may group the NCD system failure together with one or more of the failures listed in paragraphs A.1.7., A.1.8. and paragraph A.1.9.2.2 of this Annexure into a single counter.

A.1.9.2.1.3. Details of the NCD system counter(s) activation and deactivation criteria and mechanisms are described in paragraph A.1.11. of this Annexure.

A.1.9.2.2. EGR valve

A.1.9.2.2.1. The EGR system shall be monitored for an impeded EGR valve.

A.1.9.2.2.2. A counter shall be attributed to an impeded EGR valve. The EGR valve counter shall count the number of engine operating hours when the DTC associated to an impeded EGR valve is confirmed to be active.

- A.1.9.2.2.1. The manufacturer may group the impeded EGR valve failure together with one or more of the failures listed in paragraphs A.1.7., A.1.8. and A.1.9.2.1 of this Annexure. into a single counter.
- A.1.9.2.2.3. Details of the EGR valve counter activation and deactivation criteria and mechanisms are described in paragraph A.1.11. of this Annexure.
- A.1.9.3. Activation of the operator warning system
The operator warning system set out in paragraph 1.4. shall be activated in case any of the failures specified in paragraph A.1.9.1. of this Annexure occur, and shall indicate that an urgent repair is required. When the warning system includes a message display system, it shall display a message indicating either the reason of the warning (for example "reagent dosing valve disconnected", or "critical emission failure").
- A.1.9.4. Activation of the operator inducement system
- A.1.9.4.1. The low-level inducement system described in paragraph A.1.5.3. of this Annexure shall be activated if a failure specified in paragraph A.1.9.1. of this Annexure is not rectified within a maximum of **36** engine operating hours after the activation of the operator warning system set out in paragraph A.1.9.3. of this Annexure.
- A.1.9.4.2. The severe inducement system described in paragraph A.1.5.4. of this Annexure shall be activated if a failure specified in paragraph A.1.9.1. of this Annexure is not rectified within a maximum of **72** engine operating hours after the activation of the operator warning system set out in paragraph A.1.9.3. of this Annexure.
- A.1.9.4.3. The number of hours prior to activation of the inducement systems shall be reduced in case of a repetitive occurrence of the malfunction according to the mechanism described in paragraph A.1.11. of this Annexure.
- A.1.9.5. As an alternative to the monitoring requirements set out in paragraph A.1.9.2. of this Annexure, the manufacturer may monitor for failures using a NO_x sensor located in the exhaust system. In this case,
 - (a) the NO_x value at which the NCM shall be detected shall not exceed the lower of either the applicable NO_x limit multiplied by 2.25 or the applicable NO_x limit plus 1.5 g/kWh. For engine sub-categories with a combined HC and NO_x limit, the applicable NO_x limit value for the purpose of this paragraph shall be the combined limit value for HC and NO_x reduced by 0.19 g/kWh.
 - (b) a single warning may be used, including, where messages are used, the statement 'high NO_x – root cause unknown',
 - (c) in paragraph A.1.9.4.1. of this Annexure the maximum number of engine operating hours between the activation of the operator warning system and the activation of the low-level inducement system shall be 36 hours
 - (d) in paragraph A.1.9.4.2. of this Annexure the maximum number of engine operating hours between the activation of the operator warning system and the activation of the severe inducement system shall be 72 hours

A.1.10. Demonstration requirements

- A.1.10.1. General
The compliance to the requirements of this Appendix shall be demonstrated during type-approval by performing, as illustrated in Table A.8-1. and specified in paragraph A.1.10. of this Annexure:
 - (a) a demonstration of the warning system activation
 - (b) a demonstration of the low-level inducement system activation, if applicable
 - (c) a demonstration of the severe inducement system activation
- A.1.10.2. Engine families and NCD engine families
The compliance of an engine family or an NCD engine family with the requirements of paragraph A.1.10. of this Annexure may be demonstrated by testing one of the

members of the considered family, provided the manufacturer demonstrates to the Type Approval Authority that the monitoring systems necessary for complying with the requirements of this Appendix are similar within the family.

- A.1.10.2.1. The demonstration that the monitoring systems for other members of the NCD engine family are similar may be performed by presenting to the approval authorities such elements as algorithms, functional analyses, etc.
- A.1.10.2.2. The test engine is selected by the manufacturer in agreement with the Type Approval Authority. It may or may not be the parent engine of the considered family.
- A.1.10.2.3. In the case where engines of an engine family belong to an NCD engine family that has already been type-approved, according to paragraph A.1.10.2.1. (Figure A.8-3.) of this Annexure the compliance of that engine family is deemed to be demonstrated without further testing, provided the manufacturer demonstrates to the authority that the monitoring systems necessary for complying with the requirements of this Appendix are similar within the considered engine and NCD engine families.

Table A.8-1.

Illustration of the content of the demonstration process in accordance with the provisions in paragraphs A.1.10.3. and A.1.10.4.

Mechanism	Demonstration elements
Warning system activation specified in paragraph A.1.10.3. of this Annexure	2 activation tests (incl. lack of reagent) Supplementary demonstration elements, as appropriate
Low-level inducement activation specified in paragraph A.1.10.4. of this Annexure	2 activation tests (incl. lack of reagent) - Supplementary demonstration elements, as appropriate 1 The Audio-Visual Alarm
Severe inducement activation specified in paragraph A.1.10.4. of this Annexure	2 activation tests (incl. lack of reagent) - Supplementary demonstration elements, as appropriate

Figure A.8-3.

Previously demonstrated conformity of an NCD engine family

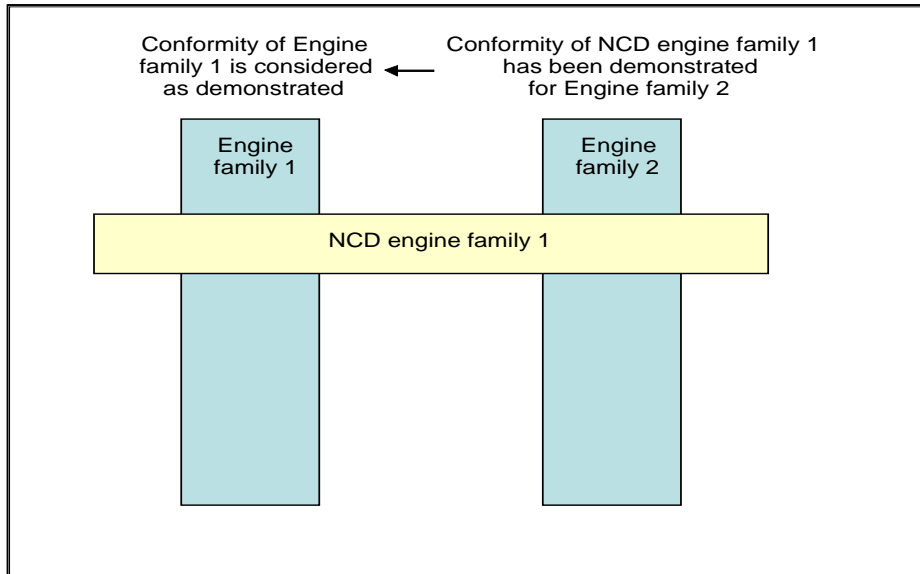

- A.1.10.3. Demonstration of the warning system activation
 - A.1.10.3.1. The compliance of the warning system activation shall be demonstrated by performing two tests: lack of reagent, and one failure category identified in paragraphs A.1.7, A.1.8. or A.1.9. of this Annexure.
 - A.1.10.3.2. Selection of the failure to be tested from paragraphs A.1.7., A.1.8., or A.1.9. of this Annexure.
 - A.1.10.3.2.1. The Type Approval Authority shall select one failure category. In the case that a failure is selected from points A.1.7. or A.1.9. of this Annexure the additional requirements set out in points A.1.10.3.2.2. or A.1.10.3.2.3. of this Annexure respectively shall apply.
 - A.1.10.3.2.2. For the purpose of demonstrating the activation of the warning system in case of a wrong reagent quality, a reagent shall be selected with a dilution of the active ingredient at least as dilute as that communicated by the manufacturer according to the requirements set out in paragraph A.1.7. of this Annexure.
 - A.1.10.3.2.3. For the purpose of demonstrating the activation of the warning system in case of failures that may be attributed to tampering, and are defined in paragraph A.1.9. of this Annexure the selection shall be performed according to the following requirements:
 - A.1.10.3.2.3.1. The manufacturer shall provide the Type Approval Authority with a list of such potential failures.
 - A.1.10.3.2.3.2. The failure to be considered in the test shall be selected by the Type Approval Authority from this list referred to in paragraph A.1.10.3.2.3.1. of this Annexure.
 - A.1.10.3.3. Demonstration
 - A.1.10.3.3.1. For the purpose of this demonstration, a separate test shall be performed for the lack of reagent and the failure selected in paragraph A.1.10.3.2. of this Annexure.
 - A.1.10.3.3.2. During a test, no failure shall be present other than the one addressed by the test.
 - A.1.10.3.3.3. Prior to starting a test, all DTC shall have been erased.
 - A.1.10.3.3.4. At the request of the manufacturer, and with the agreement of the Type Approval Authority, the failures subject to testing may be simulated.
 - A.1.10.3.3.5. Detection of failures other than lack of reagent.

For failures other than lack of reagent, once the failure installed or simulated, the detection of that failure shall be performed as follows:

- A.1.10.3.3.5.1. The NCD system shall respond to the introduction of a failure selected as appropriate by the Type Approval Authority in accordance to the provisions of this Appendix. This is demonstrated if activation occurs within two consecutive NCD test-cycles according to paragraph A.1.10.3.3.7. of this Annexure.

When it has been specified in the monitoring description and agreed by the Type Approval Authority that a specific monitor needs more than two NCD test-cycles to complete its monitoring, the number of NCD test-cycles may be increased to 3 NCD test-cycles.

Each individual NCD test-cycle in the demonstration test may be separated by an engine shut-off. The time until the next start-up shall take into consideration any monitoring that may occur after engine shut-off and any necessary condition that must exist for monitoring to occur at the next start up.

- A.1.10.3.3.5.2 The demonstration of the warning system activation is deemed to be accomplished if, at the end of each demonstration test performed according to paragraph A.1.10.3.3. of this Annexure, the warning system has been properly activated and the DTC for the selected failure has got the "confirmed and active" status.

- A.1.10.3.3.6. Detection in case of lack of reagent availability

For the purpose of demonstrating the activation of the warning system in case of lack of reagent availability, the engine shall be operated over one or more NCD test cycles at the discretion of the manufacturer.

- A.1.10.3.3.6.1. The demonstration shall start with a level of reagent in the tank to be agreed between the manufacturer and the Type Approval Authority but representing not less than 10 per cent of the nominal capacity of the tank.

- A.1.10.3.3.6.2. The warning system is deemed to have performed in the correct manner if the following conditions are met simultaneously:

- (a) the warning system has been activated with a reagent availability **greater** or equal to 10 per cent of the capacity of the reagent tank
- (b) the "continuous" warning system has been activated with a reagent availability greater or equal to the value declared by the manufacturer in accordance with the provisions of paragraph A.1.6. of this Annexure.

- A.1.10.3.3.7. NCD test cycle

- A.1.10.3.3.7.1 The NCD test cycle considered in clause A.1.10. of this Annexure for demonstrating the correct performance of the NCD system is the 5 Mode variable speed cycle for variable speed engine and the applicable D2- 5 Mode cycle for constant speed engine

- A.1.10.3.3.7.2 On request of the manufacturer with approval of the test agency, an alternative NCD Cycle (e.g. other than D2-5 Mode cycle) can be used for specific monitoring

- A.1.10.3.4. The demonstration of the warning system activation is deemed to be accomplished if, at the end of each demonstration test performed according to paragraph A.1.10.3.3. of this Annexure, the warning system has been properly activated.

- A.1.10.4. Demonstration of the inducement system

- A.1.10.4.1. The demonstration of the inducement system shall be done by tests performed on an engine test bench.

- A.1.10.4.1.1. Any components or sub-systems not physically mounted on the engine, such as, but not limited to, ambient temperature sensors, level sensors, and operator warning and information systems, that are required in order to perform the demonstrations shall be connected to the engine for that purpose, or shall be simulated, to the satisfaction of the Type Approval Authority.

- A.1.10.4.1.2. If the manufacturer chooses, and subject to the agreement of the Type Approval Authority, the demonstration tests may be performed on a complete Genset either by

mounting the same on a suitable test bed or, notwithstanding paragraph A.1.10.4.1. of this Annexure, by running it outside test laboratory under controlled conditions.

- A.1.10.4.2. The test sequence shall demonstrate the activation of the inducement system in case of lack of reagent and in case of the failure selected by the Approval Authority according to paragraph A.1.10.3.2.1. of this Annexure for the test of the warning system.
- A.1.10.4.3. For the purpose of this demonstration,
- (a) the manufacturer shall, in agreement with the Type Approval Authority, be permitted to accelerate the test by simulating the achievement of a certain number of operating hours,
 - (b) Reserved
 - (c) the low-level inducement, if applicable, shall be demonstrated according to the requirements of paragraph A.1.10.4.5. of this Annexure.
 - (d) the severe inducement shall be demonstrated according to the requirements of paragraph A.1.10.4.6. of this Annexure.
- A.1.10.4.4. The manufacturer shall, in addition, demonstrate the operation of the inducement system under those failure conditions defined in paragraphs A.1.7., A.1.8. or A.1.9. of this Annexure which have not been chosen for use in demonstration tests described in paragraphs A.1.10.4.1. to A.1.10.4.3. of this Annexure.
- These additional demonstrations may be performed by presentation to the Type Approval Authority of a technical case using evidence such as algorithms, functional analyses, and the result of previous tests.
- A.1.10.4.4.1. These additional demonstrations shall demonstrate to the satisfaction of the Type Approval Authority the inclusion of the correct torque reduction mechanism in the engine ECU.
- A.1.10.4.5. Demonstration test of the low-level inducement system
- A.1.10.4.5.1. This demonstration starts when the warning system or when appropriate "continuous" warning system has been activated as a result of the detection of a failure selected by the Type Approval Authority.
- A.1.10.4.5.2. When the system is being checked for its reaction to the case of lack of reagent in the tank, the engine shall be run until the reagent availability has reached a value of 2.5 per cent of the tank nominal full capacity of the tank or the value declared by the manufacturer in accordance with paragraph A.1.6.3.1. of this Annexure at which the low-level inducement system is intended to operate.
- A.1.10.4.5.2.1. The manufacturer may, with the agreement of the Type Approval Authority, simulate continuous running by extracting reagent from the tank, either whilst the engine is running or is stopped.
- A.1.10.4.5.3. When the system is checked for its reaction in the case of a failure other than a lack of reagent in the tank, the engine shall be run for the relevant number of operating hours indicated in Table A.8-4. or, at the choice of the manufacturer, until the relevant counter has reached the value at which the low-level inducement system is activated.
- A.1.10.4.5.4. The demonstration of the low-level inducement system shall be deemed to be accomplished if, at the end of each demonstration test performed according to paragraphs A.1.10.4.5.2. and A.1.10.4.5.3. of this Annexure, the manufacturer has demonstrated to the Type Approval Authority that the engine ECU has activated the Audio-Visual Alarm or torque reduction mechanism.
- A.1.10.4.6. Demonstration test of the severe inducement system
- A.1.10.4.6.1. This demonstration shall start from a condition where the low-level inducement system, where applicable, has been previously activated and may be performed as a continuation of the tests undertaken to demonstrate the low-level inducement system.
- A.1.10.4.6.2. When the system is checked for its reaction in the case of lack of reagent in the tank, the engine shall be run until the reagent tank is empty, or has reached the level below

2.5 per cent of nominal full capacity of the tank at which the manufacturer has declared to activate the severe inducement system.

- A.1.10.4.6.2.1. The manufacturer may, with the agreement of the Type Approval Authority, simulate continuous running by extracting reagent from the tank, either whilst the engine is running or is stopped.
- A.1.10.4.6.3. When the system is checked for its reaction in the case of a failure that is not a lack of reagent in the tank, the engine shall then be run for the relevant number of operating hours indicated in Table A.8-4. or, at the choice of the manufacturer, until the relevant counter has reached the value at which the severe inducement system is activated.
- A.1.10.4.6.4. The demonstration of the severe inducement system shall be deemed to be accomplished if, at the end of each demonstration test performed according to paragraphs A.1.10.4.6.2. and A.1.10.4.6.3. of this Annexure, the manufacturer has demonstrated to the Type Approval Authority that the severe inducement mechanism considered in this Appendix has been activated.
- A.1.10.4.7. Alternatively, if the manufacturer chooses, and subject to the agreement of the Type Approval Authority, the demonstration of the inducement mechanisms may be performed on a complete Genset in accordance with the requirements of paragraphs A.1.5.4. and A.1.10.4.1.2. of this Annexure, either by mounting the Genset on a suitable test bed or by running it outside test laboratory under controlled conditions.
- A.1.10.4.7.1. The Genset shall be operated until the counter associated with the selected failure has reached the relevant number of operating hours indicated in Table A.8-4. or, as appropriate, until either the reagent tank is empty or, has reached the level below 2.5 per cent of nominal full capacity of the tank at which the manufacturer has chosen to activate the severe inducement system.
- A.1.10.5. Documentation of the demonstration
- A.1.10.5.1 A demonstration report shall be created that documents the demonstration of the NCD system.
 - The report shall:
 - (a) identify the failures examined;
 - (b) describe the demonstration performed including the applicable test cycle;
 - (c) confirm that the applicable warnings and inducements were activated as required by this regulation;
 - (d) be included in the information folder as set out in Annexure 1.

A.1.11. Description of the operator warning and inducement activation and deactivation mechanisms

- A.1.11.1 To complement the requirements specified in this Appendix concerning the warning and inducement activation and deactivation mechanisms, paragraph A.1.11. of this Annexure specifies the technical requirements for an implementation of those activation and deactivation mechanisms.
- A.1.11.2. Activation and deactivation mechanisms of the warning system
- A.1.11.2.1. The operator warning system shall be activated when the diagnostic trouble code (DTC) associated with a NCM justifying its activation has the status defined in Table A.8-2.

Table A.8-2

Activation of the operator warning system

Failure type	DTC status for activation of the warning system
Poor reagent quality	confirmed and active
Interruption of dosing	confirmed and active
Impeded EGR valve	confirmed and active
Malfunction of the monitoring system	confirmed and active
NO _x threshold, if applicable	confirmed and active

A.1.11.2.2. The operator warning system shall be deactivated when the diagnosis system concludes that the malfunction relevant to that warning is no longer present or when the information including DTCs relative to the failures justifying its activation is erased by a scan tool.

A.1.11.2.2.1. Requirements for erasing "NO_x control information"

A.1.11.2.2.1.1. Erasing / resetting "NO_x control information" by a scan-tool

On request of the scan tool, the following data shall be erased or reset to the value specified in this Appendix from the computer memory (see Table A.8-3.).

Table A.8-3.

Erasing / resetting "NO_x control information" by a scan-tool

NO_x control information	Erasable	Resettable
All DTCs	X	
The value of the counter with the highest number of engine operating hours		X
The number of engine operating hours from the NCD counter(s)		X

A.1.11.2.2.1.2. NO_x control information shall not be erased by disconnection of the battery(ies) of the Genset.

A.1.11.2.2.1.3. The erasing of "NO_x control information" shall only be possible under "engine-off" conditions.

A.1.11.2.2.1.4. When "NO_x control information" including DTCs are erased, any counter associated with these failures and which is specified in this Appendix shall not be erased, but reset to the value specified in the appropriate paragraph of this Appendix.

A.1.11.3. Activation and deactivation mechanism of the operator inducement system

A.1.11.3.1. The operator inducement system shall be activated when the warning system is active and the counter relevant to the type of NCM justifying their activation have reached the value specified in Table A.8-4

A.1.11.3.2. The operator inducement system shall be deactivated when the system no longer detects a malfunction justifying its activation, or if the information including the DTCs relative to the NCMs justifying its activation has been erased by a scan tool or maintenance tool.

- A.1.11.3.3. The operator warning and inducement systems shall be immediately activated or deactivated as appropriate according to the provisions of paragraph A.1.6. of this Annexure after assessment of the reagent quantity in the reagent tank. In that case, the activation or deactivation mechanisms shall not depend upon the status of any associated DTC.
- A.1.11.4. Counter mechanism
 - A.1.11.4.1. General
 - A.1.11.4.1.1. To comply with the requirements of this Appendix, the system shall contain counters to record the number of hours during which the engine has been operated while the system has detected any of the following NCM:
 - (a) an incorrect reagent quality;
 - (b) an interruption of reagent dosing activity;
 - (c) an impeded EGR valve;
 - (d) a failure of the NCD system.
 - A.1.11.4.1.1.1. The manufacturer may use one or more counters for grouping the NCMs indicated in paragraph A.1.11.4.1.1. of this Annexure.
 - A.1.11.4.1.2. Each of the counters shall count up to the maximum value provided in a 2 byte counter with 1 hour resolution and hold that value unless the conditions allowing the counter to be reset to zero are met.
 - A.1.11.4.1.3. A manufacturer may use a single or multiple NCD system counters. A single counter may accumulate the number of hours of 2 or more different malfunctions relevant to that type of counter, none of them having reached the time the single counter indicates.
 - A.1.11.4.1.3.1. When the manufacturer decides to use multiple NCD system counters, the system shall be capable of assigning a specific monitoring system counter to each malfunction relevant according to this Appendix to that type of counters.
 - A.1.11.4.2. Principle of counters mechanism
 - A.1.11.4.2.1. Each of the counters shall operate as follows:
 - A.1.11.4.2.1.1. If starting from zero, the counter shall begin counting as soon as a malfunction relevant to that counter is detected and the corresponding diagnostic trouble code (DTC) has the status defined in Table A.8-2.
 - A.1.11.4.2.1.2. In case of repeated failures, one of the following provisions shall apply at the choice of the manufacturer.
 - (a) If a single monitoring event occurs and the malfunction that originally activated the counter is no longer detected or if the failure has been erased by a scan tool or a maintenance tool, the counter shall halt and hold its current value. If the counter stops counting when the severe inducement system is active, the counter shall be kept frozen at the value defined in Table A.8-4. or a value of greater than or equal to the counter value for severe inducement minus 30 minutes.
 - (b) The counter shall be kept frozen at the value defined in Table A.8-4. or a value of greater than or equal to the counter value for severe inducement minus 30 minutes.
 - A.1.11.4.2.1.3. In the case of a single monitoring system counter, that counter shall continue counting if a NCM relevant to that counter has been detected and its corresponding Diagnostic trouble code (DTC) has the status "confirmed and active". It shall halt and hold one of the values specified in paragraph A.1.11.4.2.1.2. of this Annexure, if no NCM that would justify the counter activation is detected or if all the failures relevant to that counter have been erased by a scan tool or a maintenance tool.

**Table A.8-4.
Counters and inducement**

#	DTC status for first activation of the counter	Counter value for low-level inducement	Counter value for severe inducement	Frozen value held by the counter
Reagent quality counter	confirmed and active	≤ 10 hours	≤ 72 hours	≥ 90 per cent of counter value for severe inducement
Dosing counter	confirmed and active	≤ 10hours	≤ 72hours	≥ 90 per cent of counter value for severe inducement
EGR valve counter	confirmed and active	≤ 36 hours	≤ 72hours	≥ 95 per cent of counter value for severe inducement
Monitoring system counter	confirmed and active	≤ 36 hours	≤ 72hours	≥ 95 per cent of counter value for severe inducement
NO _x threshold, if applicable	confirmed and active	≤ 10 hours	≤ 72hours	≥ 90 per cent of counter value for severe inducement

- A.1.11.4.2.1.4. Once frozen, the counter shall be reset to zero when the monitors relevant to that counter have run at least once to completion of their monitoring cycle without having detected a malfunction and no malfunction relevant to that counter has been detected during 40 engine operating hours since the counter was last held (see Figure A.8-4.).
- A.1.11.4.2.1.5. The counter shall continue counting from the point at which it had been held if a malfunction relevant to that counter is detected during a period when the counter is frozen (see Figure A.8-4.).

A.1.12. Illustration of the activation and deactivation and counter mechanisms

- A.1.12.1. This paragraph A.1.12. of this Annexure illustrates the activation and deactivation and counter mechanisms for some typical cases. The Figures and descriptions given in paragraphs A.1.12.2., A.1.12.3. and A.1.12.4. of this Annexure are provided solely for the purposes of illustration in this Appendix and should not be referenced as examples of either the requirements of this Regulation or as definitive statements of the processes involved. The counter hours in Figures A.8-6. and A.8-7. refer to the maximum severe inducement values in Table A.8-4.. For simplification purposes, for example, the fact that the warning system will also be active when the inducement system is active has not been mentioned in the illustrations given.

Figure A.8-4.
Reactivation and resetting to zero of a counter after a period when its value has been frozen

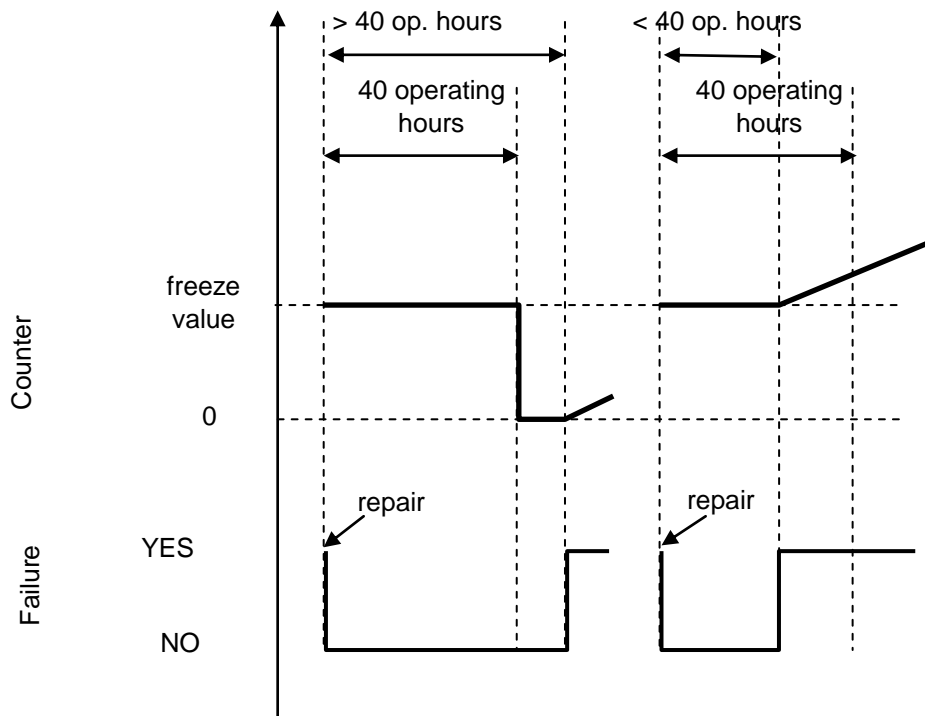

A.1.12.2. Figure A.8-5. illustrates the operation of the activation and deactivation mechanisms when monitoring the reagent availability for four cases:

- (a) use case 1: the operator continues operating the Genset in spite of the warning until Genset operation is disabled;
- (b) Adequate refilling case 1: the operator refills the reagent tank so that a level above the 10 per cent threshold is reached. Warning and inducement are de-activated;
- (c) Inadequate refilling cases 2 and 3: The warning system is activated. The level of warning depends on the amount of available reagent;
- (d) Very Inadequate refilling case 4: The low-level inducement is activated immediately.

Figure A.8-5.
Reagent availability

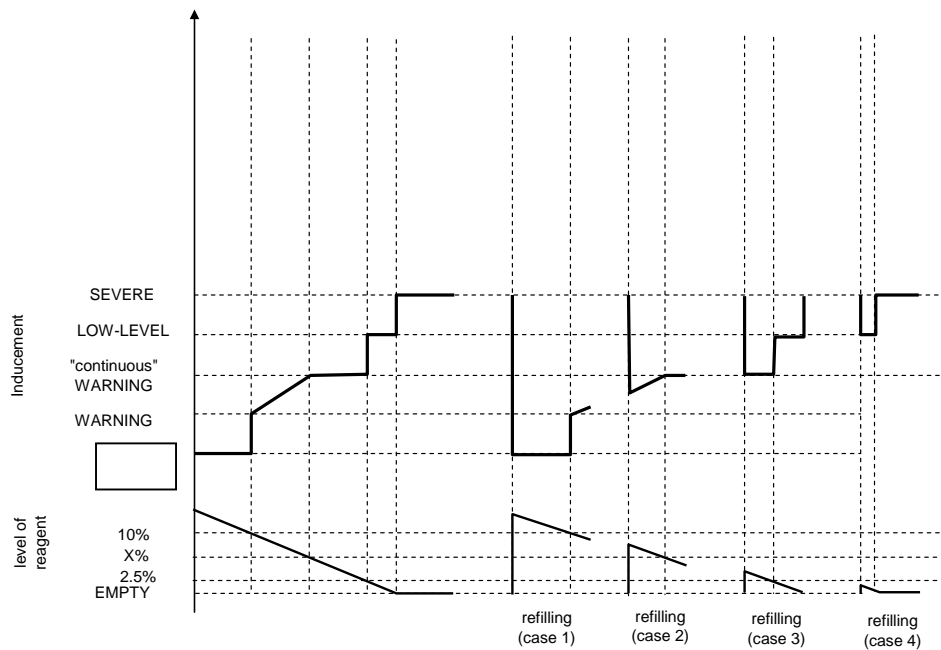

- A.1.12.3. Figure A.8-6. illustrates three cases of wrong reagent quality:
- (a) use case 1: the operator continues operating the Genset in spite of the warning until Genset operation is disabled.
 - (b) repair case 1 ("bad" or "dishonest" repair): after disablement of the Genset, the operator changes the quality of the reagent, but soon after, changes it again for a poor quality one. The warning, inducement and counting processes start from zero. The inducement system is immediately reactivated and Genset operation is disabled after 2 engine operating hours.
 - (c) repair case 2 ("good" repair): after disablement of the Genset, the operator rectifies the quality of the reagent. However, sometime afterwards, he refills again with a poor-quality reagent. The low-level inducement system is immediately reactivated and the counter restarts from the value it had at the time of repair. The warning, inducement and counting processes restart from zero.

Figure A.8-6.
Filling with poor reagent quality

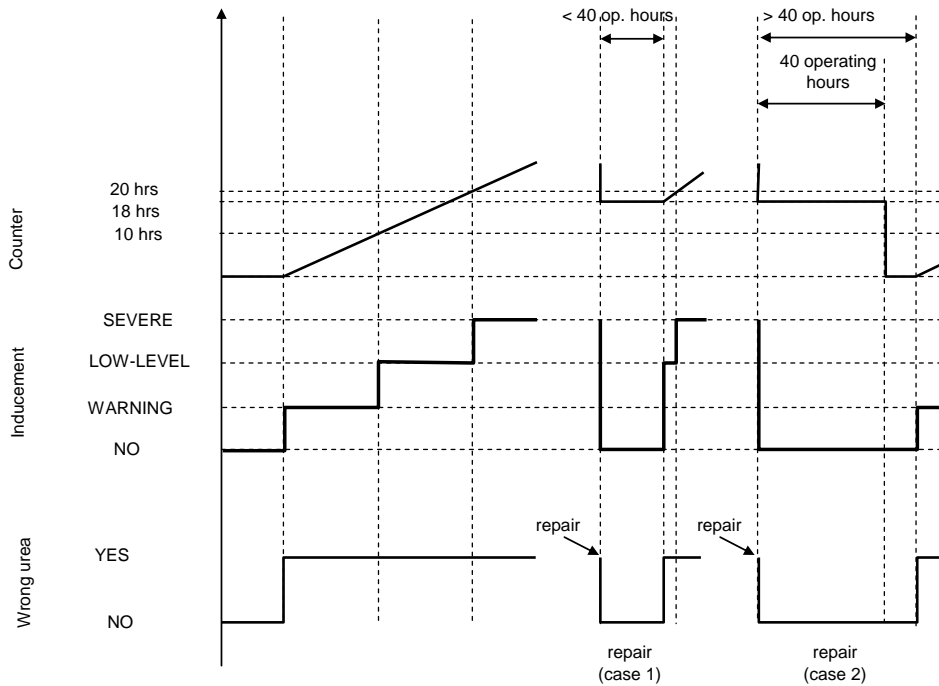

A.1.12.4. Figure A.8-7. illustrates three cases of failure of the urea dosing system. This figure also illustrates the process that applies in the case of the monitoring failures described in paragraph A.1.9. of this Annexure.

- (a) use case 1: the operator continues operating the Genset in spite of the warning until Genset operation is disabled.
- (b) repair case 1 ("good" repair): after disablement of the Genset engine, the operator repairs the dosing system. However, some time afterwards, the dosing system fails again. The warning, inducement and counting processes restart from zero.
- (c) repair case 2 ("bad" repair): during the low-level inducement time (torque reduction), the operator repairs the dosing system. Soon after, however, the dosing system fails again. The low-level inducement system is immediately reactivated and the counter restarts from the value it had at the time of repair.

**Figure A.8-7.
Failure of the reagent dosing system**

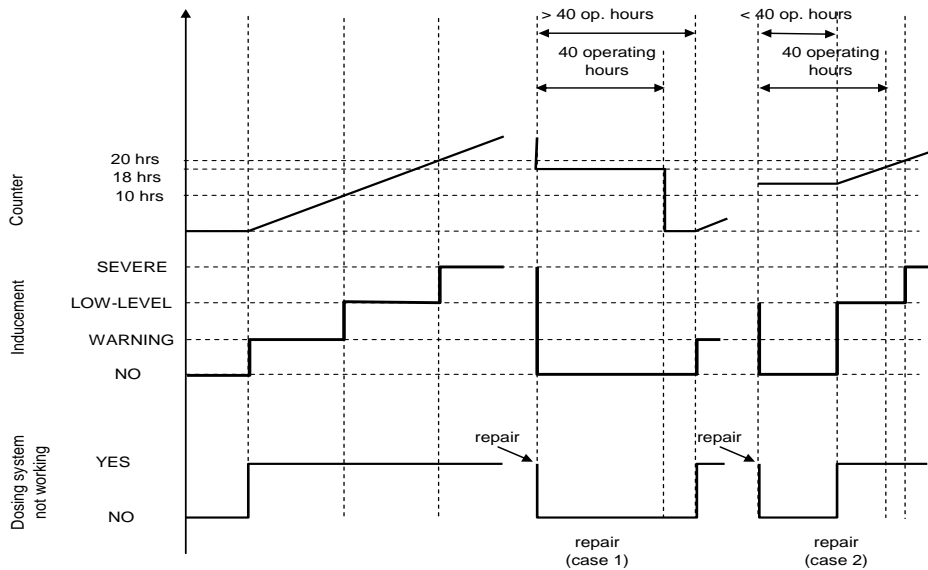

A.1.13. Demonstration of the minimum acceptable reagent concentration CD_{min}

A.1.13.1. The manufacturer shall demonstrate the correct value of CD_{min} during type approval by performing the 5-mode variable speed cycle for variable speed engines and the applicable D2-5 mode constant speed cycle for constant speed engine using a reagent with the concentration CD_{min} .

A.1.13.2. The test shall follow the appropriate NCD cycle(s), permitting a closed loop NO_x control system to perform adaptation to the quality of the reagent with the concentration CD_{min} .

A.1.13.3. The pollutant emissions resulting from this test shall not exceed the NO_x threshold specified in paragraph A.1.7.1.1. of this Annexure.

A.1.13.4. Documentation of the demonstration

A.1.13.4.1. A demonstration report shall be created that documents the demonstration of the minimum acceptable reagent concentration.

The report shall:

- (a) identify the failures examined;
- (b) describe the demonstration performed including the applicable test cycle;
- (c) confirm that the pollutant emissions arising from this demonstration did not exceed the NO_x threshold specified in point A.1.7.1.1 of this Annexure;
- (d) be included in the information folder as set out in Annexure 1

A.1.14. Technical requirements for Audible Operator warning system.

This section describes technical requirements for audible operator warning system associated with NO_x and Particulate Control Diagnostics. Same could be leveraged by manufacturer for warning of other faults such as engine de-rates due to safety reason however with different pattern.

A.1.14.1. Specification requirements for audible warning system

Audible operator warning system as installed on Genset application shall satisfy following requirements:

- (a) Sound intensity of the system as measured at distance of 1 m facing Genset panel with controls and displays those accompany operator warning lights shall be 80-85 decibels;

- (b) Such warning system (sound source) shall be all weather compatible and durable for life of Genset;
 - (c) Shall have diagnostics associated with it including DTC inline with paragraph A.1.10 of this Annexure if tampered with;
 - (d) Manufacturer may opt to integrate such warning system within Genset enclosure or may provide an external hooter compliant with above requirements;
- A.1.14.2. Audio warning system pattern requirements
- A.1.14.2.1. Audio warning system for operator inducements shall be enabled per any of the options below:
- Option: A**
- A.1.14.2.1.1 When operator warning has become active for low-level inducement, activate visual warning with no alarms.
 - A.1.14.2.1.2. At commencement of low-level inducement, the audio warning system shall beep once in 5 seconds with 2-second-long beep. Such audio warning shall remain active as long as low-level inducement state is active.
 - A.1.14.2.1.3. At commencement of severe-level inducement, the audio warning system shall beep once in 2 seconds with 2-second-long beep. Such audio warning shall remain active when Engine Ignition is ON or Engine shutdown but ignition is ON.
- Option: B**
- A.1.14.2.1.4 Any specific pattern of alarm with specific duration and frequency of beeps that will alert the operator on Inducements as defined by the manufacturer which needs to be demonstrated at the time of testing as part of Inducement strategy
 - A.1.14.2.4. Manufacture may opt to use same audio warning pattern as paragraph A.1.14.2.1.3 of this Annexure for non-inducement fault codes those are engine and equipment safety related and will cause immediate derate or shutdown of an engine;
- A.1.14.3. Audio warning system extent requirements
- A.1.14.3.1. Audio warning associated with low-level inducement commencement shall remain active as long as low-level inducement state is active;
 - A.1.14.3.2. Audio warning associated with severe-level inducement commencement shall remain active when Engine Ignition is ON or Engine shutdown but ignition is ON.
- A.1.14.4. Details of the operator warning system activation and deactivation procedures are described in paragraph A.1.11. of this Annexure those shall apply to audio warning system;
- A.1.14.5. As part of the application for approval under this Regulation, the manufacturer shall demonstrate the operation of the audio operator warning system, as specified in paragraph A.1.10. of this Annexure;

Appendix – A.2

Technical requirements on Particulate pollutant control measures including the method to demonstrate these measures

A.2.1. Introduction

This Appendix sets out the requirements to ensure the correct operation of particulate control measures.

A.2.2. General requirements

The engine shall be equipped with a Particulate Control Diagnostic system (PCD) able to identify the particulate after-treatment system malfunctions considered by this Annexure. Any engine covered by this paragraph shall be designed, constructed and installed so as to be capable of meeting these requirements throughout the normal life of the engine under normal conditions of use. In achieving this objective, it is acceptable that engines which have been used in excess of the emission durability period as specified in Appendix 6 to Annexure 7 of this Regulation show some deterioration in the performance and the sensitivity of the PCD.

A.2.2.1. Required information

A.2.2.1.1. If the emission control system requires a reagent e.g. fuel borne catalyst, the characteristics of that reagent, including the type of reagent, information on concentration when the reagent is in solution, operational temperature conditions and reference to international standards for composition and quality must be specified by the manufacturer, in the information document set out in Annexure 1.

A.2.2.1.2. Detailed written information fully describing the functional operation characteristics of the operator warning system in paragraph A.2.4. of this Annexure shall be provided to the Type Approval Authority at the time of type-approval.

A.2.2.1.3. The manufacturer shall provide installation documents that, when used by the OEM, will ensure that the engine, inclusive of the emission control system that is part of the approved engine type or engine family, when installed in the genset, will operate, in conjunction with the necessary machinery parts, in a manner that will comply with the requirements of this Annexure. This documentation shall include the detailed technical requirements and the provisions of the engine (software, hardware, and communication) needed for the correct installation of the engine in the genset.

A.2.2.2. Operating conditions

A.2.2.2.1. The PCD system shall at a minimum be operational at the applicable control conditions set out in paragraph 2.4 of Appendix for each engine category. The diagnostic system shall remain operational outside of this range where technically possible.

A.2.2.3. Diagnostic requirements

A.2.2.3.1. The PCD system shall be able to identify the particulate control malfunctions (PCM) considered by this Appendix by means of Diagnostic Trouble Codes (DTCs) stored in the computer memory and to communicate that information off-board upon request.

A.2.2.3.2. Requirements for recording Diagnostic Trouble Codes (DTCs)

A.2.2.3.2.1. The PCD system shall record a DTC for each distinct PCM.

A.2.2.3.2.2. The PCD system shall conclude within the periods of engine operation indicated in Table A8-5. whether a detectable malfunction is present. At this time, a “confirmed and active” DTC shall be stored and the warning system specified in paragraph A.2.4. of this Annexure shall be activated.

A.2.2.3.2.3. In cases where more than the period of running time indicated in Table A.8-5. is required for the monitors to accurately detect and confirm a PCM (e.g. monitors using statistical models or with respect to fluid consumption on the Genset), the Type

Approval Authority may permit a longer period for monitoring provided the manufacturer justifies the need for the longer period (for example by technical rationale, experimental results, in-house experience, etc.).

**Table A.8-5.
Monitor types and corresponding period within which a “confirmed and active” DTC shall be stored**

Monitor type	Period of accumulated running time within which a “confirmed and active” DTC shall be stored
Removal of the particulate after-treatment system	60 minutes of non-idle engine operation
Loss of function of the particulate after-treatment system	240 minutes of non-idle engine operation
Failures of the PCD system	60 minutes of engine operation

A.2.2.3.3. Requirements for erasing Diagnostic trouble codes (DTCs):

- (a) DTCs shall not be erased by the PCD system itself from the computer memory until the failure related to that DTC has been remedied;
- (b) the PCD system may erase all the DTCs upon request of a proprietary scan or maintenance tool that is provided by the engine manufacturer upon request, or using a pass code provided by the engine manufacturer.
- (c) the record of incidents of operation with a DTC confirmed and active that are stored in non-volatile memory as required by paragraph A.2.5.2. of this Annexure shall not be erased.

A.2.2.3.4. A PCD system shall not be programmed or otherwise designed to partially or totally deactivate based on age of the genset during the actual life of the engine, nor shall the system contain any algorithm or strategy designed to reduce the effectiveness of the PCD system over time.

A.2.2.3.5. Any reprogrammable computer codes or operating parameters of the PCD system shall be resistant to tampering.

A.2.2.3.6. PCD engine family

The manufacturer is responsible for determining the composition of a PCD engine family. Grouping engines within a PCD engine family shall be based on good engineering judgment and be subject to approval by the Type Approval Authority.

Engines that do not belong to the same engine family may still belong to the same PCD engine family.

A.2.2.3.6.1. Parameters defining a PCD engine family

A PCD engine family is characterized by basic design parameters that shall be common to engines within the family.

In order that engines are considered to belong to the same PCD engine family, the following list of basic parameters shall be similar:

- (a) working principle of particulate after-treatment system (e.g. mechanical, aerodynamic, diffusional, inertial, periodically regenerating, continuously regenerating, etc.)

- (b) methods of PCD monitoring;
- (c) criteria for PCD monitoring;
- (d) monitoring parameters (e.g. frequency).

These similarities shall be demonstrated by the manufacturer by means of relevant engineering demonstration or other appropriate procedures and subject to the approval of the Type Approval Authority.

The manufacturer may request approval by the Type Approval Authority of minor differences in the methods of monitoring/diagnosing the PCD monitoring system due to engine configuration variation, when these methods are considered similar by the manufacturer and they differ only in order to match specific characteristics of the components under consideration (for example size, exhaust flow, etc.); or their similarities are based on good engineering judgment.

A.2.3. Maintenance Requirements

- A.2.3.1. The OEM shall provide to all end-users of gensets written instructions about the emission control system and its correct operation.

A.2.4. Operator Warning System

- A.2.4.1. The genset shall include an operator warning system using visual alarms.
- A.2.4.2. The operator warning system may consist of one or more lamps, or display short messages.

The system used for displaying these messages may be the same as the one used for other maintenance or NCD purposes

The warning system shall indicate that an urgent repair is required. When the warning system includes a message display system, it shall display a message indicating the reason of the warning (for example “sensor disconnected”, or “critical emission failure”)

- A.2.4.3. The warning system shall include an audible component to alert the operator in line with A.1.14 of this Annexure. An audible alarm system must be activated at minimum when the operator inducement system described in paragraph A.2.6. of this Annexure has been activated. The cancelling of audible warnings by the operator is permitted.
- A.2.4.4. The operator warning system shall be activated as specified in paragraph A.2.2.3.2.2 of this Annexure.
- A.2.4.5. The operator warning system shall be deactivated when the conditions for its activation have ceased to exist. The operator warning system shall not be automatically deactivated without the reason for its activation having been remedied.
- A.2.4.6. The warning system may be temporarily interrupted by other warning signals providing important safety related messages.
- A.2.4.7. In the application for type-approval under this Regulation, the manufacturer shall demonstrate the operation of the operator warning system, as specified in paragraph A.2.9. of this Annexure.

A.2.5. System to store information on operator warning system activation

- A.2.5.1. The PCD system shall include a non-volatile computer memory or counters to store incidents of engine operation with a DTC confirmed and active in a manner to ensure that the information cannot be intentionally deleted.
- A.2.5.2. The PCD shall store in the non-volatile memory the total number and duration of all incidents of engine operation with a DTC confirmed and active when the operator warning system has been active for 20 hours of engine operation, or a shorter period at the choice of the manufacturer.
- A.2.5.3. It shall be possible for State and Central Pollution Control Board and other authorities to read these records with a scan tool.

- A.2.5.4. A description of the connection for, and method to read, these records shall be included in the information folder as set out in Annexure 1.
- A.2.6. Reserved.
- A.2.7. Monitoring for removal of the particulate after-treatment system**
- A.2.7.1. The PCD system shall detect the complete removal of the particulate after-treatment system inclusive of the removal of any sensors used to monitor, activate, de-activate or modulate its operation.
- A.2.8. Additional requirements in the case of a particulate after-treatment system that uses a reagent (eg fuel borne catalyst)**
- A.2.8.1. In the case of a confirmed and active DTC for either removal of the particulate after-treatment system or loss of the particulate after-treatment system function the reagent dosing shall be immediately interrupted. Dosing shall re-commence when the DTC is no longer active.
- A.2.8.2. The warning system shall be activated if the reagent level in the additive tank falls below the minimum value specified by the manufacturer.
- A.2.9. Monitoring failures that may be attributed to tampering**
- A.2.9.1. In addition to monitoring for removal of the particulate after-treatment system the following failures shall be monitored because they may be attributed to tampering:
- (a) loss of the particulate after-treatment system function,
 - (b) failures of the PCD system, as described in paragraph A.2.9.3. of this Annexure.
- A.2.9.2. Monitoring of loss of the particulate after-treatment system function
- The PCD shall detect the complete removal of the particulate after-treatment system substrate (“empty can”). In this case the particulate after-treatment system housing and sensors used to monitor, activate, de-activate or modulate its operation are still present.
- A.2.9.3. Monitoring of failures of the PCD system
- A.2.9.3.1. The PCD system shall be monitored for electrical failures and for removal or deactivation of any sensor or actuator that prevents it from diagnosing any other failures mentioned in paragraphs A.2.7.1. and A.2.9.1(a) (component monitoring) of this Annexure.
- A non-exhaustive list of sensors that affect the diagnostic capability are those directly measuring differential pressures over the particulate after-treatment system and exhaust temperature sensors for controlling the particulate after-treatment system regeneration.
- A.2.9.3.2. Where the failure, removal or deactivation of a single sensor or actuator of the PCD system does not prevent the diagnosis within the required time period of the failures mentioned in paragraphs A.2.7.1. and A.2.9.1(a) of this Annexure (redundant system), the activation of the warning system and storage of information on operator warning system activation shall not be required unless additional sensor or actuator failures are confirmed and active.
- A.2.10 Demonstration requirements**
- A.2.10.1 General
- The compliance to the requirements of this Appendix shall be demonstrated during type-approval by performing, as illustrated in Table A.8-6. and specified in paragraph A.2.10. of this Annexure a demonstration of the warning system activation.

Table A.8-6.

Illustration of the content of the demonstration process in accordance with the provisions in paragraph A.2.10.3 of this Annexure.

Mechanism	Demonstration elements
Warning system activation specified in paragraph A.2.4.4. of this Annexure	- 2 activation tests (incl. loss of the particulate after-treatment system function) - Supplementary demonstration elements, as appropriate

A.2.10.2. Engine families and PCD engine families

A.2.10.2.1. In the case where engines of an engine family belong to a PCD engine family that has already been type-approved in accordance with paragraph A.2.2.3.6. of this Annex (Figure A.8-8), the compliance of that engine family is deemed to be demonstrated without further testing, provided the manufacturer demonstrates to the authority that the monitoring systems necessary for complying with the requirements of this Appendix are similar within the considered engine and PCD engine families.

Figure A.8-8.

Previously demonstrated conformity of a PCD engine family

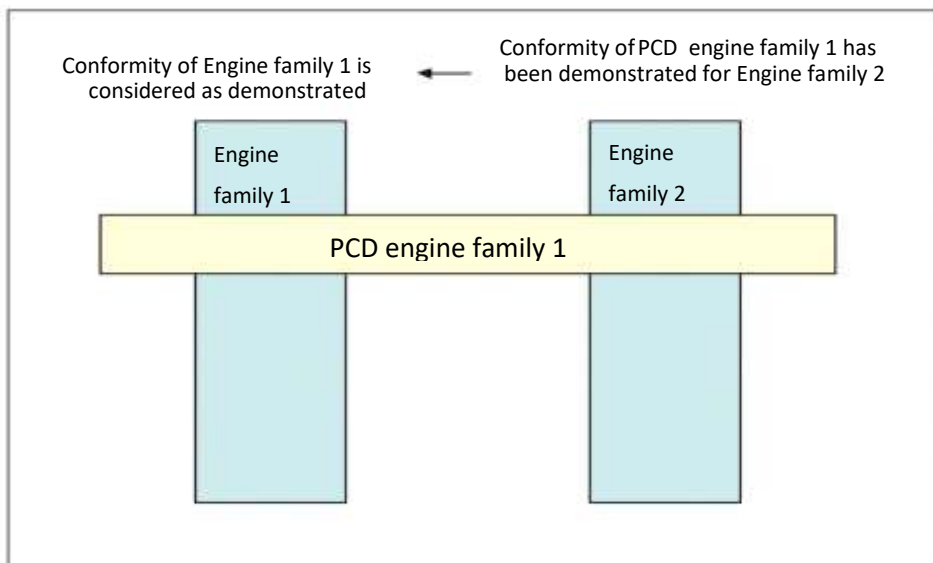

A.2.10.3. Demonstration of the warning system activation

A.2.10.3.1. The compliance of the warning system activation shall be demonstrated by performing two tests: loss of the particulate after-treatment system function and one failure category considered in paragraph A.2.7. or paragraph A.2.9.3. of this Annexure.

A.2.10.3.2. Selection of the failures to be tested

A.2.10.3.2.1. The manufacturer shall provide the Type Approval Authority with a list of such potential failures.

A.2.10.3.2.2. The failure to be considered in the test shall be selected by the Type Approval Authority from this list referred to in paragraph A.2.10.3.2.1. of this Annex.

A.2.10.3.3. Demonstration

- A.2.10.3.3.1. For the purpose of this demonstration, a separate test shall be performed for the loss of the particulate after-treatment system function set out in paragraph A.2.8.2. of this Annexure and for the failures laid down in paragraphs A.2.7. and A.2.9.3. of this Annexure. The loss of the particulate after-treatment system function shall be created by a complete removal of the substrate from the particulate after-treatment system housing.
- A.2.10.3.3.2. During a test, no failure shall be present other than the one addressed by the test.
- A.2.10.3.3.3. Prior to starting a test, all DTC shall have been erased.
- A.2.10.3.3.4. At the request of the manufacturer, and with the agreement of the Type Approval Authority, the failures subject to testing may be simulated.
- A.2.10.3.3.5. Detection of failures
- A.2.10.3.3.5.1. The PCD system shall respond to the introduction of a failure selected as appropriate by the Type Approval Authority in accordance to the provisions of this Appendix. This is considered to be demonstrated if activation occurs within the number of consecutive PCD test-cycles given in Table A.8-7.

When it has been specified in the monitoring description and agreed by the Type Approval Authority that a specific monitor needs more PCD test-cycles to complete its monitoring than indicated in Table A.8-7., the number of PCD test-cycles may be increased by up to 50 per cent

Each individual PCD test-cycle in the demonstration test may be separated by an engine shut-off. The time until the next start-up shall take into consideration any monitoring that may occur after engine shut- off and any necessary condition that must exist for monitoring to occur at the next start-up.

Table A.8-7.

Monitor types and corresponding number of PCD test cycles within which a “confirmed and active” DTC shall be stored

Monitor type	Number of PCD test cycles within which a “confirmed and active” DTC shall be stored
Removal of the particulate after-treatment system	2
Loss of function of the particulate after-treatment system	8
Failures of the PCD system	2

A.2.10.3.3.6 PCD test cycle

- A.2.10.3.3.6.1. The PCD test cycle considered in this paragraph A.2.10. of this Annexure for demonstrating the correct performance of the particulate after-treatment system monitoring system is 5 Mode variable speed test cycle for variable speed engines and the D2 5mode constant speed cycle for constant speed engines categories.
- A.1.10.3.3.6.2 On request of the manufacturer with approval of the test agency, an alternative NCD Cycle (e.g. other than D2-5 Mode cycle) can be used for specific monitoring
- A.2.10.3.3.7 Configuration for demonstration of the warning system activation
- A.2.10.3.3.7.1. The demonstration of the warning system activation shall be done by tests performed on an engine test bench.

- A.2.10.3.3.7.2. Any components or subsystems not physically mounted on the engine, such as, but not limited to, ambient temperature sensors, level sensors, and operator warning and information systems, that are required in order to perform the demonstrations shall be connected to the engine for that purpose, or shall be simulated, to the satisfaction of the Type Approval Authority.
- A.2.10.3.3.7.3. If the manufacturer chooses, and subject to the agreement of the Type Approval Authority, the demonstration tests may be performed, notwithstanding paragraph A.2.10.3.3.7.1. of this Annexure, on a complete Genset either by mounting the genset on a suitable test bed or by running it outside test laboratory under controlled conditions.
- A.2.10.3.4. The demonstration of the warning system activation is deemed to be accomplished if, at the end of each demonstration test performed in accordance with to paragraph A.2.10.3.3. of this Annexure the warning system has been properly activated and the DTC for the selected failure has a “confirmed and active” status.
- A.2.10.3.5. Where a particulate after-treatment system that uses a reagent is subjected to a demonstration test for loss of the particulate after-treatment system function or removal of the particulate after-treatment system it shall also be confirmed that reagent dosing has been interrupted.
- A.2.10.3.6. Documentation of the demonstration**
- A.2.10.3.6.1 A demonstration report shall be created that documents the demonstration of the PCD system.
- The report shall:
- (a) identify the failures examined;
 - (b) describe the demonstration performed including the applicable test cycle;
 - (c) confirm that the applicable warnings were activated as required by this regulation;
 - (d) be included in the information folder as set out in Annex 1.

Appendix – A.3

Technical details for prevention of tampering

- A.3.1. For engine types and engine families that use an ECU as part of the emission control system the manufacturer shall provide to the approval authority a description of the provisions taken to prevent tampering with and modification of the ECU including the facility for updating using a manufacturer-approved program or calibration;
- A.3.2. For engine types and engine families that use mechanical devices as part of the emission control system the manufacturer shall provide to the approval authority a description of the provisions taken to prevent tampering with and modification of the adjustable parameters of the emission control system. This shall include the tamper resistant components. Such as Fuel injection pump limiter caps or sealing of Fuel injection pump screws or special screws not adjustable by user.
 - A.3.2.1. The manufacturer shall demonstrate to the Test Agency that the adjustable parameters of the emission control system cannot be easily tampered by applying reasonable forces, either:
 - (a) using the tools supplied together with the engine; or,
 - (b) using ordinary tools such as screwdriver, pliers (including cutting pliers) or wrenches.Ordinary tools do not include: most cutting or grinding tools, drills and rotary cutters, or tools that generate excessive heat or flame.
- A.3.3. For the purpose of this Appendix, engines from different engine families may be further combined into families based upon the type and design of tamper prevention measures utilized. In order to place engines from different engine families into the same tamper prevention engine family the manufacturer shall provide confirmation to the approval authority that the measures used to prevent tampering are similar. In this case the requirements of paragraphs A.3.1. and A.3.2. of this Annexure may be performed for one representative engine and the corresponding documentation used during the type approval of all engines in the same tamper prevention engine family.
- A.3.4. Manufacturers shall provide a warning in the operator's manual stating that tampering with the engine voids the type-approval of that particular engine.

Appendix – A.4

Technical details for Remote Information and Monitoring Requirements

A.4.1. General Requirements

A.4.1.1. Gensets powered by electronically controlled engines with >56 kW power shall be equipped with remote information and monitoring system utilizing telematics.

Gensets unlike non-road machines and On road vehicles are operated typically without human intervention and does not have an 'Operator' required to be present during its operation. This makes 'Operator Warning System' in line with non-road machines difficult to follow through as well as getting timely inputs to the operator of a Genset.

A.4.1.2. Manufacturer in conjunction with GOEM shall provide a cellular data based remote information monitoring system that is capable of working with Application (App) able to work with desktop computers and cellular hand-held devices such cellphone. Such app once installed shall be able to provide essential information and warnings to Genset owner/s, operator/s highlighting any mal-function related to emission control by a suitable "Engine Malfunction" icon indicated prominently on the user interface.

A.4.1.3. Manufacturer may choose to demonstrate the remote monitoring function as mentioned in A.4.1.2 on engine test bench during engine type approval and COP or on the Genset during Genset type approval & COP.

ANNEXURE – 9

Installation in the Genset Application

9.1. Information and instructions intended for OEMs and end-users.

- 9.1.1. A manufacturer shall not supply to GOEMs or end-users any technical information related to the particulars provided for in this Regulation which diverges from the particulars approved by the Type Approval Authority;
- 9.1.2. The manufacturer shall make available to GOEMs all relevant information and instructions that are necessary for the correct installation of an engine in Genset, including a description of any special conditions or restrictions linked to the installation or use of the engine;
- 9.1.3. The manufacturer shall make available to GOEMs all relevant information and necessary instructions intended for the end-user, including a description of any special conditions or restrictions linked to the use of an engine.
- 9.1.4. Details of the relevant information and instructions for the GOEMs are set out in Appendix 1 to Annexure 9.

9.2. Obligations of GOEMs concerning the installation of engines

- 9.2.1. GOEMs shall install approved engines in Genset in accordance with the instructions provided by the manufacturer pursuant to paragraph 9.1.2, and in a manner that does not adversely affect the engine's performance with regard to its gaseous and particulate pollutant emissions;
- 9.2.2. Where an GOEM does not follow the instructions referred to in paragraph 9.2.1., or modifies an engine in the course of its installation of genset, in a manner that adversely affects the engine's performance with regard to its gaseous and particulate pollutant emissions, that GOEM shall be considered to be a manufacturer for the purposes of this Regulation and shall, in particular, be subject to the obligations laid down in clauses 3, 4 and 5 of this Regulation;
- 9.2.3. OEMs shall install type-approved engine(s) in genset(s) only in accordance with the kinds of exclusive use provided for the engine categories set out in clause 1.
- 9.2.5. Details of the relevant information and instructions for the end-users are set out in Appendix 2 to Annexure 9;
- 9.2.6. For the use of Dual Fuel engine in GENSET, the safety code of practice to be followed along with the instructions provided by the manufacturer pursuant to paragraph 9.1.2, and in a manner that does not adversely affect the engine's performance with regard to its gaseous and particulate pollutant emissions; The test agency will certify the installation of the engine in GENSET canopy as per safety code of practice. The separate document 'A4' named "SAFETY CODE OF PRACTICE" shall be referred for more clarification. The noise level certificate shall be issued only after compliance of GENSET to safety code of practice.

Appendix – 1

Details of the relevant information and instructions for the GOEMs

- A.1.1. As required by paragraph 9.1., the manufacturer shall provide to the GOEM all relevant information and instructions to ensure that the engine conforms to the approved engine type when installed in Gensets. Instructions for this purpose shall be clearly identified to the GOEM;
- A.1.2. The instructions may be provided on paper or a commonly used electronic format;
- A.1.3. Where a number of engines requiring the same instructions are supplied to the same GOEM it shall be necessary to provide one set of instructions at minimum;
- A.1.4. The information and instructions to the OEM shall include at minimum:
 - A.1.4.1. installation requirements to achieve the emissions performance of the engine type, including the emission control system, that shall be taken into account to ensure the correct operation of the emissions control system;
 - A.1.4.2. a description of any special conditions or restrictions linked to the installation or use of the engine, as noted on the communication set out in Annexure 1
 - A.1.4.3. a statement indicating that the installation of the engine shall not permanently constrain the engine to exclusively operate within a power range corresponding to a (sub-)category with gaseous and particulate pollutant emission limits more stringent than the (sub-) category the engine belongs to;
For e.g.:
 - a) Engine certified for > 56 KW power can be permanently constrained to power less than 56 KW
 - b) However, engine certified for > 560 KW power cannot be permanently constrained to power less than 560 KW
 - A.1.4.4. for engine families to which appendix 2 of annexure 7 of this Regulation applies, the upper and lower boundaries of the applicable control area and a statement indicating that the installation of the engine shall not constrain the engine to exclusively operate at speed and load points outside of the control area for the torque curve of the engine;
 - A.1.4.5. where applicable, design requirements for the components supplied by the OEM that are not part of the engine and are necessary to ensure that, when installed, the engine conforms to the approved engine type;
 - A.1.4.6. where applicable, design requirements for the reagent tank, including freeze protection, monitoring of reagent level and means to take samples of reagent;
 - A.1.4.7. where applicable, information on installation of a non-heated reagent system;
 - A.1.4.9. where applicable, a statement indicating that the OEM shall provide a warning system as set out in Appendices 1, 2 and 3 of Annexure 8;
 - A.1.4.10. where applicable, information on the interface between the engine and genset for the operator warning system, referred to in paragraph A.1.4.9.;
 - A.1.4.11. where applicable, information on the interface between the engine and Genset for the operator inducement system, as set out in Annexure 8;
 - A.1.4.12. where applicable, information on a means to temporarily disable the operator inducement as defined in Annexure 8;
 - A.1.4.13. where applicable, information on the inducement override function as defined in Annexure 8;
 - A.1.4.14. in the case of dual-fuel engines:
 - (a) a statement indicating that the GOEM shall provide a dual-fuel operating mode indicator as described in clause 4.3.1 of annexure 10

- (b) a statement indicating that the GOEM shall provide a dual-fuel warning system as described in clause 4.3.1 of annexure 10
 - (c) information on the interface between the engine and the Genset for the operator indication and warning system, referred to in paragraphs A1.4.14. (a) and (b);
- A.1.4.15. In the case of a constant-speed engine equipped with alternative speeds as set out in paragraph 4.1.2.3. of Clause 4:
- (a) a statement indicating that the installation of the engine shall ensure that:
 - i. the engine is stopped prior to resetting the constant-speed governor to an alternative speed; and,
 - ii. the constant-speed governor is only set to the alternative speeds permitted by the engine manufacturer;
 - (b) details of each (sub-)category and operating mode (speed operation) for which the engine is type-approved and may be set when installed;
- A.1.4.16. In the case that the engine is equipped with an idle speed for start-up and shut-down, a statement indicating that the installation of the engine shall ensure that the constant-speed governor function is engaged prior to increasing the load-demand to the engine from the no-load setting.
- A.1.5. The manufacturer shall provide to the GOEM all information and necessary instructions that the GOEM shall provide to the end-users in accordance with Appendix 2 to Annexure 9.

Appendix – 2

Details of the relevant information and instructions for the end-users

- A.2.1. The GOEM shall provide to the end-users all information and necessary instructions for the correct operation of the engine in order to maintain the gaseous and particulate pollutant emissions of the engine within the limits of the approved engine type or engine family. Instructions for this purpose shall be clearly identified to the end-users.
- A.2.2. The instructions to the end-users shall be:
 - A.2.2.1. written in a clear and non-technical manner using the same language that is used in the instructions to end-users for gensets;
 - A.2.2.2. be provided on paper or, alternatively, a commonly used electronic format;
 - A.2.2.3. be part of the instructions to end-users for the Genset,
- A.2.3. The information and instructions to the end-users shall include at least:
 - A.2.3.1. a description of any special conditions or restrictions linked to the use of the engine, as noted on the type-approval communication;
 - A.2.3.2. a statement indicating that the engine, including the emissions control system, shall be operated, used and maintained in accordance with the instructions provided to the end-users in order to maintain the emissions performance of the engine within the requirements applicable to the engine's category;
 - A.2.3.3. a statement indicating that no deliberate tampering with or misuse of the engine emissions control system should take place; in particular, with regard to deactivating or not maintaining an exhaust gas recirculation (EGR) or a reagent dosing system;
 - A.2.3.4. a statement indicating that it is essential to take prompt action to rectify any incorrect operation, use or maintenance of the emissions control system in accordance with the rectification measures indicated by the warnings referred to in paragraph A.2.3.5. and A.2.3.6.;
 - A.2.3.5. detailed explanations of the possible malfunctions of the emissions control system generated by incorrect operation, use or maintenance of the installed engine and due to failure to emission control system components, accompanied by the associated warning signals and the corresponding rectification measures;
 - A.2.3.6. detailed explanations of the possible incorrect use of the Genset that would result in malfunctions of the engine emissions control system, accompanied by the associated warning signals and the corresponding rectification measures;
 - A.2.3.7. for gensets with an operator warning system, a statement indicating that the operator will be informed by the operator warning system when the emission control system does not function correctly;
 - A.2.3.8. for Genset with an operator inducement system a statement indicating that ignoring the operator warning signals will lead to the activation of the operator inducement system, resulting in an effective disablement of genset operation;
 - A.2.3.9. for Genset with an inducement override function for releasing full engine power justified by safety concerns or to allow for self-healing diagnostics, information about the operation of this function;
 - A.2.3.10. where applicable, explanations of how the operator warning and inducement systems referred to in paragraphs A.2.3.7., A.2.3.8. and A.2.3.9. operate, including the consequences, in terms of performance and fault logging, of ignoring the warning system signals and of not replenishing, where used, the reagent or rectifying the problem identified;
 - A.2.3.11. for genset with a means to disable the operator inducement, information about the operation of this function, and a statement indicating that this function shall be only activated in case of emergencies, that any activation will be recorded in the on-board computer log and that Central

or State pollution Control Board inspection authorities will be able to read these records with a scan tool;

- A.2.3.12. information on the fuel(s) necessary to maintain the performance of the emissions control system in particular:
- (a) where the engine is to be operated on diesel, a statement indicating that a fuel with sulphur content not greater than 10 mg/kg or 10 PPM, cetane number not less than 51 and an FAME content not greater than 7.0 per cent v/v shall be used;
 - (b) where additional fuels, fuel mixtures or fuel emulsions are compatible with use by the engine, as declared by the manufacturer and stated in the type-approval communication, these shall be indicated. Such fuel type shall be constrained by alternate fuel definitions of this Regulation;
- A.2.3.13. information on the lubrication oil specifications necessary to maintain the performance of the emissions control system;
- A.2.3.14. where the emission control system requires a reagent, the generic name, characteristics of that reagent, including the type of reagent, information on concentration when the reagent is in solution, operational temperature conditions and reference to Indian and international standards for composition and quality, consistent with the specification set-out in the engine type-approval;
- A.2.3.15. where applicable, instructions specifying how consumable reagents have to be refilled by the operator between normal maintenance intervals. They shall indicate how the operator should refill the reagent tank and the anticipated frequency of refill, depending upon of the genset based on average per day operation;
- A.2.3.16. a statement indicating that in order to maintain the emissions performance of the engine, it is essential to use and refill reagent in accordance with the specifications set out in clause A.2.3.14. and A.2.3.15.;
- A.2.3.17. scheduled emission-related maintenance requirements including any scheduled exchange of critical emission-related components;
- A.2.3.18. in the case of dual-fuel engines:
- (a) where applicable, information on the dual-fuel indicators,
 - (b) where a dual-fuel engine has operability restrictions in a service mode, a statement indicating that the activation of the service mode will result in an effective disablement of the Genset,
 - (c) where an inducement override function for releasing full engine power is available, information about the operation of this function shall be provided,

ANNEXURE – 10

Technical requirements for dual-fuel engines (Diesel + Alternate Fuel)

1.0 Scope

This Annex shall apply for dual-fuel engines when engine is being operated simultaneously on both a liquid and a gaseous fuel (dual-fuel mode).

This Annex shall not apply for testing engines, including dual-fuel engines, when they are being operated solely on liquid or solely on gaseous fuels (i.e. when the GER is either 1 or 0 according to the type of fuel). In this case the requirements are the same as for any single-fuel engine.

2. Definitions and abbreviations

For the purposes of this Annex the following definitions shall apply

- 2.1. "GER (Gas Energy Ratio)" has the meaning defined in paragraph 2 of this Regulation based on the lower heating value;
- 2.2. "GER_{cycle}" means the average GER when operating the engine on the applicable engine test cycle;
- 2.3. "Dual-fuel Type 1A engine" means either:
 - (a) dual-fuel engine, that operates over test-cycles as mentioned in appendix1 of annexure 7 of part 1 of this document with an average gas energy ratio that is not lower than 90 per cent ($GER \geq 0.9$) and that does not idle using exclusively liquid fuel, and that has no liquid-fuel mode,
- 2.4. "Dual-Fuel Type 1B engine" means either:
 - (a) dual-fuel engine, that operates over test-cycles as mentioned in appendix1 of annexure 7 of part 1 of this document with an average gas energy ratio that is not lower than 90 % ($GER \geq 0.9$) and that does not idle using exclusively liquid fuel in dual-fuel mode, and that has a liquid-fuel mode,
- 2.5. "Dual-Fuel Type 2A engine" means either:
 - (a) dual-fuel engine, that operates over test-cycles as mentioned in appendix1 of annexure 7 of part 1 of this document with an average gas energy ratio between 10 per cent and 90 per cent ($0.1 < GER < 0.9$) and that has no liquid-fuel mode or that operates over the hot part of the NRTC test-cycle with an average gas energy ratio that is not lower than 90 per cent ($GER \geq 0.9$), but that idles using exclusively liquid fuel, and that has no liquid-fuel mode;
- 2.6. "Dual-Fuel Type 2B engine" means either:
 - (a) dual-fuel engine, that operates over test-cycles as mentioned in appendix1 of annexure 7 of part 1 of this document with an average gas energy ratio between 10 per cent and 90 per cent ($0.1 < GER < 0.9$) and that has a liquid-fuel mode or that operates over the hot part of the NRTC test-cycle with an average gas energy ratio that is not lower than 90 per cent ($GER \geq 0.9$), and that has a liquid-fuel mode but that can idle using exclusively liquid fuel in dual-fuel mode
- 2.7. "Dual-Fuel Type 3B engine" means either:
 - (a) dual-fuel engine, that operates over test-cycles as mentioned in appendix1 of annexure 7 of part 1 of this document with an average gas energy ratio that does not exceed 10 per cent ($GER \leq 0.1$) and that has a liquid-fuel mode,

3. Dual-fuel specific additional approval requirements

3.1. Engines with operator-adjustable control of GER_{cycle} .

In the case for a given engine type the value of GER_{cycle} can be reduced from the maximum by an operator-adjustable control, the minimum GER_{cycle} shall not be limited but the engine shall be capable of meeting the emission limit values at any value of GER_{cycle} permitted by the manufacturer.

4. General requirements

4.1. Operating modes of dual-fuel engines

4.1.1. Conditions for a dual-fuel engine to operate in liquid mode

A dual-fuel engine may only operate in liquid-fuel mode if, when operating in liquid-fuel mode, it has been certified according to all the requirements of this Regulation concerning operation solely on the specified liquid fuel.

When a dual-fuel engine is developed from an already certified liquid-fuel engine, then a new type approval certificate is required in the liquid-fuel mode.

4.1.2. Conditions for a dual-fuel engine to idle using liquid fuel exclusively

4.1.2.1. Dual-fuel Type 1A engines shall not idle using liquid fuel exclusively except under the conditions defined in paragraph 4.1.3. of this Annex for warm-up and start.

4.1.2.2. Dual-fuel Type 1B engines shall idle using liquid fuel exclusively in dual-fuel mode.

4.1.2.3. Dual-fuel Types 2A, 2B and 3B engines may idle using liquid fuel exclusively.

4.1.3. Conditions for a dual-fuel engine to warm-up or start using liquid fuel solely

4.1.3.1. A Type 1B, Type 2B, or Type 3B dual-fuel engine may warm-up or start using liquid fuel solely. In the case that the emission control strategy during warm-up or start-up in dual-fuel mode is the same as the corresponding emission control strategy in liquid-fuel mode the engine may operate in dual-fuel mode during warm-up or start-up. If this condition is not met the engine shall only warm-up or start-up using liquid fuel solely when in liquid-fuel mode.

4.1.3.2. A Type 1A or Type 2A dual-fuel engine may warm-up or start-up using liquid fuel solely. However, in that case, the strategy shall be declared as an AECS and the following additional requirements shall be met:

4.1.3.2.1. The strategy shall cease to be active when the coolant temperature has reached a temperature of 343 K (70 °C), or within 15 minutes after it has been activated, whichever occurs first; and

4.1.3.2.2. The service mode shall be activated while the strategy is active.

4.2. Service mode

4.2.1. Conditions for dual-fuel engines to operate in service mode

When an engine is operating in service mode it is subject to an operability restriction and is temporarily exempted from complying with the requirements related to exhaust emissions and NO_x control described in this Regulation.

4.2.2. Operability restriction in service mode

4.2.2.1. Requirement

The operability restriction applicable to a dual-fuel engine operated in service mode is the one activated by the "severe inducement system"

In order to account for safety concerns and to allow for self-healing diagnostics, use of an inducement override function for releasing full engine power is permitted

The operability restriction shall not otherwise be deactivated by either the activation or deactivation of the warning and inducement systems.

The activation and the deactivation of the service mode shall not activate or deactivate the warning and inducement systems

4.2.2.2. Reserved

4.2.2.3. Activation of the operability restriction

The operability restriction shall be automatically activated when the service mode is activated.

In the case where the service mode is activated because of a malfunction of the gas supply system, the operability restriction shall become active within 30 minutes operating time after the service mode is activated.

In the case where the service mode is activated because of an empty gaseous fuel tank, the operability restriction shall become active as soon as the service mode is activated.

4.2.2.4. Deactivation of the operability restriction

The operability restriction system shall be deactivated when the engine no longer operates in service mode.

4.2.3. Unavailability of gaseous fuel when operating in a dual-fuel mode

(a) Dual-fuel engines of Types 1A and 2A shall activate the service mode;

(b) Dual-fuel engines of Types 1B, 2B and 3B shall operate in liquid mode.

4.2.3.1. Unavailability of gaseous fuel – empty gaseous fuel tank (Here onwards, it is to be considered for engines/gensets supplied with cascade systems for CNG/LPG)

In the case of an empty gaseous fuel tank, the service mode or, the liquid fuel mode shall be activated as soon as the engine system has detected that the tank is empty.

When the gas availability in the tank again reaches the level that justified the activation of the empty tank warning system, the service mode may be deactivated, or, when appropriate, the dual-fuel mode may be reactivated.

4.2.3.2. Unavailability of gaseous fuel – malfunctioning gas supply

In the case of a malfunctioning gas supply system that causes the unavailability of gaseous fuel, the service mode or, as appropriate, the liquid fuel mode shall be activated when gaseous fuel supply is not available.

As soon as the gaseous fuel supply becomes available the service mode may be deactivated, or, when appropriate, the dual-fuel mode may be reactivated.

4.3. Dual-fuel indicators

4.3.1. Dual-fuel operating mode indicator

The Genset shall provide to the operator a visual indication of the mode under which the engine operates (dual-fuel mode, liquid mode, or service mode).

The characteristics and the location of this indicator shall be left to the discretion of the OEM and may be part of an already existing visual indication system.

This indicator may be completed by a message display. The system used for displaying the messages referred to in this paragraph may be the same as the ones used for NO_x control diagnostics, or other maintenance purposes.

The visual element of the dual-fuel operating mode indicator shall not be the same as the one used for the purpose of NO_x control diagnostics, or for other engine maintenance purposes.

Safety alerts always have display priority over the operating mode indication.

4.3.1.1. The dual-fuel mode indicator shall be set to service mode as soon as the service mode is activated (i.e. before it becomes actually active) and the indication shall remain as long as the service mode is active.

4.3.1.2. The dual-fuel mode indicator shall be set for at least one minute on dual-fuel mode or liquid-fuel mode as soon as the engine operating mode is changed from liquid fuel to dual-fuel mode or vice-versa. This indication is also required for at least one minute at key-on, or at the request of the manufacturer at engine cranking. The indication shall also be given upon the operator's request.

4.3.2. Empty gaseous fuel tank warning system (dual-fuel warning system) (Applicable in case of genset with CNG cascade system)

Genset fitted with a dual-fuel engine shall be equipped with a dual-fuel warning system that alerts the operator that the gaseous fuel tank will soon become empty.

The dual-fuel warning system shall remain active until the tank is refuelled to a level above which the warning system is activated.

The dual-fuel warning system may be temporarily interrupted by other warning signals providing important safety-related messages.

It shall not be possible to turn off the dual-fuel warning system by means of a scan-tool as long as the cause of the warning activation has not been rectified.

4.3.2.1. Characteristics of the dual-fuel warning system

The dual-fuel warning system shall consist of a visual alert system (icon, pictogram, etc.) left to the choice of the manufacturer.

It may include, at the choice of the manufacturer, an audible component. In that case, the cancelling of that component by the operator is permitted.

The visual element of the dual-fuel warning system shall not be the same as the one used for the purpose of NO_x control diagnostics, or for other engine maintenance purposes.

In addition, the dual-fuel warning system may display short messages, including messages indicating clearly the remaining distance or time before the activation of the operability restriction.

The system used for displaying the warning or messages referred to in this paragraph may be the same as the one used for displaying the warning or messages related the NO_x control diagnostics, or warning or messages for other maintenance purposes.

4.4. Communicated torque

4.4.1. Communicated torque when a dual-fuel engine operates in dual-fuel mode

When a dual-fuel engine operates in dual-fuel mode:

(a) The reference torque curve retrievable shall be the one obtained when that engine is tested on an engine test bench in the dual-fuel mode;

(b) The recorded actual torques (indicated torque and friction torque) shall be the result of the dual-fuel combustion and not the one obtained when operating with liquid fuel exclusively.

4.4.2. Communicated torque when a dual-fuel engine operates in liquid-fuel mode

When a dual-fuel engine operates in liquid-fuel mode, the reference torque curve retrievable shall be the one obtained when the engine is tested on an engine test bench in liquid-fuel mode.

- 4.5. Additional requirements
- 4.5.1. Where used for a dual-fuel engine, shall comply with the following requirements:
- (a) The engine shall always remain within the dual-fuel engine type (that is Type 1A, Type 2B, etc.) that has been declared for the type-approval; and
 - (b) In case of a Type 2 engine, the resulting difference between the highest and the lowest maximum GER_{cycle} within the family shall never exceed the range set out
- 4.6 The type approval shall be conditional upon providing to the OEM and end-users, in accordance with the clauses mentioned in this Regulation, instructions for installation and operation of the dual-fuel engine including the service mode set out in paragraph 4.2. and the dual-fuel indicator system set out in paragraph 4.3.

5. Performance requirements

- 5.1. The performance requirements, including emission limit values, and the requirements for type-approval applicable to dual-fuel engines are identical to those of any other diesel engine of the respective engine category as set out in this Regulation, except as set out in this paragraph 5.
- 5.2 NMHC & RHC to be considered in place of THC for dual fuel engines operated on natural gas and LPG respectively
- 5.3 The technical requirements on emission control strategies, including documentation required to demonstrate these strategies, technical provisions to resist tampering and the prohibition of defeat devices are identical to those of any other diesel engine of the respective engine category
- 5.4 Reserved

6. Demonstration requirements

- 6.1. The demonstration requirements applicable to dual-fuel engines are identical to those of any other diesel engine of the respective engine category as set out in this Regulation, except as set out in paragraph 6. of this Annex.
- 6.2. Compliance with the applicable limit values shall be demonstrated in dual-fuel mode.
- 6.3. For dual-fuel engine types with a liquid-fuel mode (i.e. types 1B, 2B, 3B) compliance with the applicable limit values shall additionally be demonstrated in liquid-fuel mode.
- 6.4. Additional demonstration requirements in case of a Type 2 engine
- 6.4.1 The manufacturer shall present the Type Approval Authority with evidence showing that the GER_{cycle} span of all members of the dual-fuel engine family remains within the range specified, or in the case of engines with an operator-adjustable GER_{cycle} satisfy the requirements as specified in this document (for example, through algorithms, functional analyses, calculations, simulations, results of previous tests, etc.).
- 6.5 Additional demonstration requirements in case of an engine with an operator-adjustable GER_{cycle}
- 6.5.1 Compliance with the applicable limit values shall be demonstrated at the minimum and maximum value of GER_{cycle} permitted by the manufacturer.
- 6.6. Requirements for demonstrating the durability of a dual-fuel engine
- 6.6.1 Provisions of Appendix 6 of Annex 7 shall apply.
- 6.7. Demonstration of the dual-fuel indicators, warning and operability restriction
- 6.7.1 As part of the application for type-approval under this Regulation, the manufacturer shall demonstrate the operation of dual-fuel indicators and of the warning and operability restriction in accordance with the provision made in this document.

- 6.8 Documentation of the demonstration
A demonstration report shall document the demonstration conducted to comply with paragraph 6 of this Annex. The report shall:
- (a) describe the demonstration performed, including the applicable test cycle;
 - (b) be included in the information folder

7. Requirements to ensure the correct operation of NO_x control measures

- 7.1. Annex 8 (on technical requirements on NO_x control measures) shall apply to dual-fuel engines, whether operating in dual-fuel or liquid mode.
- 7.2. Additional NO_x control requirements in case of Type 1B, Type 2B and Type 3B dual-fuel engines
- 7.2.1. The torque considered to apply to the severe inducement defined in Appendix A.1 of Annex 8 shall be the lowest of the torques obtained in liquid-fuel mode and in dual-fuel mode.
- 7.2.2. A possible influence of the mode of operation on the malfunction detection shall not be used to extend the time until an inducement becomes active.
- 7.2.3. In the case of malfunctions, the detection of which does not depend on the operation mode of the engine, the mechanisms specified in Annex 8 that are associated with the DTC status shall not depend on the operation mode of the engine (for example, if a DTC reached the potential status in dual-fuel mode, it will get the confirmed and active status the next time the failure is detected, even in liquid-fuel mode).
- 7.2.4. In the case of malfunctions where the detection depends on the operation mode of the engine, DTCs shall not get a previously active status in a different mode than the mode in which they reached the confirmed and active status.
- 7.2.5. A change of the mode of operation (dual-fuel to liquid fuel or vice-versa) shall not stop nor reset the mechanisms implemented to comply with the specification of Annex 8 (counters, etc.). However, in the case where one of these mechanisms (for example a diagnostic system) depends on the actual operation mode the counter associated with that mechanism may, at the request of the manufacturer and upon approval of the Type Approval Authority:
- (a) Halt and, when applicable, hold their present value when the operation mode changes;
 - (b) Restart and, when applicable, continue counting from the point at which they have been held when the operation mode changes backs to the other operation mode.

Appendix – A.1

Dual-fuel engine dual-fuel indicator, warning system, operability restriction - Demonstration requirements

A.1.1. Dual-fuel indicators

A.1.1.1. Dual-fuel mode indicator

The ability of the engine to command the activation of the dual-fuel mode indicator when operating in dual-fuel mode shall be demonstrated at type-approval.

A.1.1.2. Liquid-fuel mode indicator

In the case of a Type 1B, Type 2B, or Type 3B dual-fuel engine the ability of the engine to command the activation of the liquid-fuel mode indicator when operating in liquid-fuel mode shall be demonstrated at type-approval.

A.1.1.3. Service mode indicator

The ability of the engine to command the activation of the service mode indicator when operating in service mode shall be demonstrated at type-approval.

A.1.1.3.1. When so-equipped it is sufficient to perform the demonstration related to the service mode indicator by activating a service mode activation switch and to present the Type Approval Authority with evidence showing that the activation occurs when the service mode is commanded by the engine system itself (for example, through algorithms, simulations, result of in-house tests, etc. ...).

A.1.2. Warning system

The ability of the engine to command the activation of the warning system in the case that the amount of gaseous fuel in the gaseous fuel tank is below the warning level, shall be demonstrated at type-approval. For that purpose the actual amount of gaseous fuel may be simulated.

A.1.3. Operability restriction

In the case of a Type 1A or Type 2A dual-fuel engine the ability of the engine to command the activation of the operability restriction upon detection of an empty gaseous fuel tank and of a malfunctioning gas supply system shall be demonstrated at type-approval. For that purpose the empty gaseous fuel tank and the malfunctioning of the gas supply may be simulated.

A.1.3.1. It is sufficient to perform the demonstration in a typical use-case selected with the agreement of the Type Approval Authority and to present that authority with evidence showing that the operability restriction occurs in the other possible use-cases (for example, through algorithms, simulations, result of in-house tests, etc).

Appendix – A.2

Emission test procedure requirements for dual-fuel engines

A.2.1. General

This Appendix defines the additional requirements and exceptions to enable emission testing of dual-fuel engines independent whether these emissions are solely exhaust emissions or also crankcase emissions added to the exhaust emissions according to Appendix 5 of Annexure 7. In the case that no additional requirement or exception is listed, the requirements of this Regulation shall apply to dual-fuel engines in the same way as they apply to any other approved engine types or engine families.

Emission testing of a dual-fuel engine is complicated by the fact that the fuel used by the engine can vary between pure liquid fuel and a combination of mainly gaseous fuel with only a small amount of liquid fuel as an ignition source. The ratio between the fuels used by a dual-fuel engine can also change dynamically depending of the operating condition of the engine. As a result, special precautions and restrictions are necessary to enable emission testing of these engines.

A.2.2. Test conditions

Test conditions similar to diesel engine shall apply as given in Annexure 7

Test procedure similar to diesel engine shall apply as given in Annexure 7

A.2.4. Measurement procedures

Measurement procedures shall apply as per diesel engine given in Annex 7

A full-flow dilution measurement procedure for dual-fuel engines is similar to diesel engine and to be followed accordingly

This measurement procedure ensures that the variation of the fuel composition during the test will mainly influence the hydrocarbon measurement results. This shall be compensated via one of the methods described in paragraph A.2.7 of this Appendix.

Raw gaseous/partial flow measurement procedure for dual-fuel engines is similar to diesel engine and to be followed accordingly

A.2.5. Measurement equipment

Measurement equipment shall be as per diesel engines as given in Annexure 4

A.2.6. Particle number emissions measurement

Particle number emissions measurement shall be as per diesel engine procedure

A.2.7. Emission calculation

The emission calculation shall be performed according to diesel engine except set out in appendix below. The additional requirements set out in Annexure 5 shall be applicable.

The emission calculation requires knowledge of the composition of the fuels being used. When a gaseous fuel is supplied with a certificate confirming the properties of the fuel (e.g. gas from bottles) it is acceptable to use the composition specified by the supplier. Where the composition is not available (e.g. pipeline fuel) the fuel composition shall be analysed at least prior to and after the engine emission test is conducted. More frequent analysis shall be permitted and the results used in the calculation.

Where the gas energy ratio (GER) is used it shall be consistent with the definition as specified in this document. and the specific provisions on hydrocarbon (HC) limits for fully and partially gaseous-fuelled engines as specified in this Regulation. The average value of GER over the cycle shall be calculated by multiplying the average GER for each test mode by the corresponding weighting factor for that mode and calculating the sum for all modes. The weighting factors shall be applicable similar to diesel engine.

A.2.7.1. Mass-based emission calculation

Procedure similar to diesel engines, as given in Annexure 5 shall be applicable.

A.2.7.1.1. Dry/wet correction

A.2.7.1.1.1 Raw exhaust gas

Annexure 5 shall be used to calculate the dry/wet correction factor. The fuel specific parameters shall be determined in accordance with paragraph A.2.7.1 of this document.

A.2.7.1.1.2. Diluted exhaust gas

Annex 5 shall be used to calculate the wet/dry correction.

The molar hydrogen ratio α of the combination of the two fuels shall be used for the dry/wet correction. This molar hydrogen ratio shall be calculated from the fuel consumption measurement values of both fuels in accordance with paragraph A.2.7.1

A.2.7.1.2. NO_x correction for humidity

The NO_x humidity correction for compression ignition engines as specified in Annex 5 shall be used.

A.2.7.1.3. Partial flow dilution (PFS) and raw gaseous measurement

A.2.7.1.3.1. Determination of exhaust gas mass flow

The exhaust mass flow shall be determined using a raw exhaust flowmeter as described in Annex 5.

Alternatively, the airflow and air to fuel ratio measurement method according to Annex 5 may be used the use of a zirconia-type sensor to determine the air fuel ratio is not allowed.

In the case of testing engines subject to steady-state test cycles only the exhaust gas mass flow may be determined by the air and fuel measurement method in accordance with Annex 5.

A.2.7.1.3.2. Determination of the gaseous components

Requirements of Annex 5 shall apply except as set out in this paragraph.

The possible variation of fuel composition will influence all the u_{gas} factors and molar component ratios used in the emission calculations. One of the following approaches shall be used to determine u_{gas} factors and molar component ratios at the choice of the manufacturer.

- (a) The exact equations in Annex 5 shall be applied to calculate instantaneous values of u_{gas} using the instantaneous proportions of liquid and gaseous fuel (determined from instantaneous fuel consumption measurements or calculations) and instantaneous molar component ratios or,
- (b) When the mass-based calculation in Annex 5 is used for the specific case of a dual-fuel engine operated on gas and diesel fuel, tabulated values may be used for the molar component ratios and u_{gas} values. These tabulated values shall be applied as follows:
 - i. For engines operated on the applicable test cycle with an average gas energy ratio greater than or equal to 90 per cent ($GER \geq 0.9$) the required values shall be those for the gaseous fuel taken from Table A.7-1
 - ii. For engines operated on the applicable test cycle with an average gas energy ratio between 10 per cent and 90 per cent ($0.1 < GER < 0.9$) the required values shall be assumed to be represented by those for a mixture of 50 % gaseous fuel and 50 % diesel fuel taken from Tables A.7-2 and A.7-3
 - iii. For engines operated on the applicable test cycle with an average gas energy ratio less than or equal to 10 per cent ($GER \leq 0.1$) the required values shall be those for diesel fuel taken from taken from Table A.7-4
 - iv. For the calculation of HC emissions, the u_{gas} value of the gaseous fuel shall be used in all cases irrespective of the average gas energy ratio (GER).

Table A.7-1.

**Raw exhaust gas u and component densities for $GER \geq 0.9$
(for emission concentration expressed in ppm)**

Gaseous fuel	Gas						
		NO _x	CO	HC	CO ₂	O ₂	CH ₄
	ρ_{gas} [kg/m ³]						
	ρ_{ϵ}	2.053	1.25	(a)	1.9636	1.4277	0.716
	$u_{gas}^{(b)}$						
CNG/LNG/Bio-Methane ^(c)	1.2661	0.001621	0.000987	0.000528 ^d	0.001551	0.001128	0.000565
Propane	1.2805	0.001603	0.000976	0.000512	0.001533	0.001115	0.000559
Butane	1.2832	0.0016	0.000974	0.000505	0.00153	0.001113	0.000558
LPG ^(e)	1.2811	0.001602	0.000976	0.00051	0.001533	0.001115	0.000559
(a) depending on fuel							
(b) at $l = 2$, dry air, 273 K, 101.3 kPa							
(c) u accurate within 0.2 % for mass composition of: C = 66 - 76 per cent; H = 22 - 25 per cent; N = 0 - 12 per cent (CH ₄ , G ₂₀ , G ₂₃ , and G ₂₅)							
(d) NMHC on the basis of CH _{2.93} (for total HC the u_{gas} coefficient of CH ₄ shall be used)							
(e) u accurate within 0.2 % for mass composition of: C ₃ = 27 - 90 per cent; C ₄ = 10 - 73 per cent (LPG Fuels A and B)							

Table A.7-2.

Molar component ratios for a mixture of 50 per cent gaseous fuel and 50 per cent diesel fuel (mass per cent) for $(0.1 < GER < 0.9)$

Gaseous fuel	α	γ	δ	ϵ
CH ₄	2.8681	0	0	0.0040
G _R	2.7676	0	0	0.0040
G ₂₃	2.7986	0	0.0703	0.0043
G ₂₅	2.7377	0	0.1319	0.0045
Propane	2.2633	0	0	0.0039
Butane	2.1837	0	0	0.0038
LPG	2.1957	0	0	0.0038
LPG Fuel A	2.1740	0	0	0.0038
LPG Fuel B	2.2402	0	0	0.0039

Table A.7-3

Raw exhaust gas u_{gas} values and component densities for a mixture of 50 per cent gaseous fuel and 50 per cent diesel fuel (mass per cent) for (0.1 < GER < 0.9)

Gaseous fuel	Gas							
	ρ_e	NO _x	CO	HC	CO ₂	O ₂	CH ₄	
		ρ_{gas} [kg/m ³]						
		2.053	1.250	(a)	1.9636	1.4277	0.716	
$u_{gas}^{(b)}$								
CNG/LNG^(c)	1.2786	0.001606	0.000978	0.000528 ^(c)	0.001536	0.001117	0.000560	
Propane	1.2869	0.001596	0.000972	0.000510	0.001527	0.001110	0.000556	
Butane	1.2883	0.001594	0.000971	0.000503	0.001525	0.001109	0.000556	
LPG^(e)	1.2881	0.001594	0.000971	0.000506	0.001525	0.001109	0.000556	

(a) depending on fuel
 (b) at $\lambda = 2$, dry air, 273 K, 101.3 kPa
 (c) u accurate within 0.2 % for mass composition of: C = 58 - 76 per cent; H = 19 - 25 per cent; N = 0 - 14 per cent (CH₄, G₂₀, G₂₃, and G₂₅)
 (d) NMHC on the basis of CH_{2.93} (for total HC the u_{gas} coefficient of CH₄ shall be used)
 (e) u accurate within 0.2 % for mass composition of: C₃ = 27 - 90 per cent; C₄ = 10 - 73 per cent (LPG Fuels A and B)

Table A.7-4

Raw exhaust gas u_{gas} values and component densities for GER ≤ 0.1

Fuel	Gas							
	ρ_e	NO _x	CO	HC	CO ₂	O ₂	CH ₄	
		ρ_{gas} [kg/m ³]						
		2.053	1.250	(a)	1.9636	1.4277	0.716	
$u_{gas}^{(b)}$								
Diesel	1.2943	0.001586	0.000966	0.000479	0.001517	0.001103	0.000553	

(a) depending on fuel
 (b) at $\lambda = 2$, dry air, 273 K, 101.3 kPa

A.2.7.1.3.3. Particulate determination

For the determination of particulate emissions with the partial dilution measurement method the calculation shall be performed according to the equations in Annex 5.

The requirements of Annex 5 shall apply for controlling the dilution ratio. In particular, if the combined transformation time of the exhaust flow measurement and the partial flow system exceeds 0.3 s, look-ahead control based on a pre-recorded test run shall be used. In this case, the combined rise time shall be ≤ 1 s and the combined delay time ≤ 10 s. Except in the case that the exhaust mass flow is measured directly the determination of exhaust mass flow shall use values of α , γ , δ and ϵ determined according to paragraph A.2.7.1

A.2.7.1.3.4. Additional requirements regarding the exhaust gas mass flowmeter

The flowmeter shall not be sensitive to the changes in exhaust gas composition and density. The small errors of e.g. pitot tube or orifice-type of measurement (equivalent with the square root of the exhaust density) may be neglected.

A.2.7.1.4. Full flow dilution measurement (CVS)

Requirement as mentioned in Annex 5 shall apply except as set out in this paragraph.

The possible variation of the fuel composition will mainly influence the tabulated hydrocarbon u_{gas} value. The exact equations shall be applied for the calculation of the hydrocarbon emissions using the molar component ratios determined from the fuel consumption measurements of both fuels according to paragraph A.2.7.1

A.2.7.1.4.1. Determination of the background corrected concentrations

To determine the stoichiometric factor, the molar hydrogen ratio α of the fuel shall be calculated as the average molar hydrogen ratio of the fuel mix during the test according to paragraph A.2.7.1

Alternatively, the F_s value of the gaseous fuel may be used as mentioned in Annex 5.

A.2.7.1.5. Determination of molar component ratios

For molar based emission calculations, refer procedure laid down in Annexure 5

A.2.7.2. CO₂ determination

Procedure applicable in Annex 5 shall apply

Appendix – A.3

Types of dual-fuel engines operated on natural gas/ biomethane or LPG and a liquid fuel – illustration of the definitions and main requirements

Dual-fuel type	GER _{cycle}	Idle on liquid fuel	Warm-up on liquid fuel	Operation on liquid fuel solely	Operation in absence of gas	Comments
1A	GER ≥ 0.9	NOT allowed	Allowed only on service mode	Allowed only on service mode	Service mode	
1B	GER ≥ 0.9	Allowed only on liquid-fuel mode	Allowed only on liquid-fuel mode	Allowed only on liquid-fuel and service modes	Liquid-fuel mode	
2A	0.1 < GER < 0.9	Allowed	Allowed only on service mode	Allowed only on service mode	Service mode	
2B	0.1 < GER < 0.9	Allowed	Allowed	Allowed	Liquid-fuel mode	
3A	Neither defined nor allowed					
3B	GER ≤ 0.1	Allowed	Allowed	Allowed	Liquid-fuel mode	

Appendix – A.4

SAFETY CHECKS FOR USE OF GASEOUS FUELLED (DUAL FUEL / DEDICATED DUAL FUEL AS APPLICABLE) INTERNAL COMBUSTION ENGINE

Sr. No.	Gas Kit Component	Certifying / Verifying Authority	Applicable Standards
1	Regulator (For CNG & BIO-CNG) / Regulator and Vaporizer(LNG)*	Testing of the component as per IS: 15713 or ISO-15500 by test agency. Alternatively, test agency to verify the test certificate or report conforming to the above standard issued by accredited testing laboratory.	IS: 15713 or ISO -15500
		LNG regulator and Vaporizer / heat exchanger shall meet requirements of UN R110 or equivalent standard	UN R 110 or equivalent standard
2	Gas-Air Mixer*	Testing of the component as per IS: 15714 or ISO-15500 by test agency. Alternatively, test agency to verify the test certificate or report conforming to the above standard issued by accredited testing laboratory.	IS: 15714 or ISO-15500
3	Gas Injector*	Testing of the component as per ISO-15500-7 by test agency. Alternatively, test agency to verify the test certificate or report conforming to the above standard issued by accredited testing laboratory.	ISO-15500-7
4	Gas Solenoid Valve / Automatic Shutoff valve*	Testing of the component as per IS: 15712 or ISO-15500 by test agency. Alternatively, test agency to verify the test certificate or report conforming to the above standard issued by accredited testing laboratory.	IS: 15712 or ISO-15500
		Automatic shutoff valve of LNG System (which comes in contact with LNG shall meet requirements of UN R110 or equivalent standards)	Automatic shutoff Valve for LNG System : UN R110 or equivalent standards
5	Testing of Conduit*	Testing of the component or verification of certificate or test report as per IS: 15715 by test agency.	IS: 15715
6	CNG / BIO-CNG / LNG fuel line		
6.1	High pressure exceeding 100 kPa*		
6.1.1	Exceeding 2.15 MPa		
	Rigid pipe	Testing of the component or verification of certificate or test report as per IS : 15716 by test agency.	IS: 15716

		LNG rigid pipeline shall meet requirements of UN R 110 or IS : 15716 or equivalent standard.	UN R 110 or IS: 15716 or equivalent standard.
	Flexible hose	Testing of the component or verification of certificate or test report as per IS 15718 by test agency.	IS 15718 or AIS-028 (Rev. 1) (Part A)
		LNG flexible pipeline shall meet requirements of UN R110 or IS: 15718 or equivalent standard.	UN R 110 or IS: 15718 or equivalent standard
6.1.2	Pressure upto 2.15 Bar	Testing of the component or verification of certificate or test report as per IS : 15722 by test agency.	IS : 15722 with amendments
		LNG pipeline shall meet requirements of UN R 110 or IS : 15722 or equivalent standard.	UN R 110 or IS: 15722 or equivalent standard
6.2	Joints and connections*	Testing by test agency.	Clause 3.1.4.1, 3.2.1 (b) of AIS-028 (Rev. 1) (Part A)
		LNG joints & connection shall meet requirements of UN R 110 or equivalent standard	UN R 110 or equivalent standard
7	Compartment or Sub-compartment*	Testing of the component or verification of certificate or test report as per IS: 15720 by test agency.	IS: 15720
8	Specific LNG components	Following specific components, as applicable shall meet requirements of UN R 110 or equivalent standard LNG Fuel pump, Pressure Relief valves, Pressure sensor, check valve, excess flow valve, manual valve and non-return valve.	UN R 110 or equivalent standard
9	Safety check for installation of Gaseous fuel system	Safety checks to be carried out by test agency as per AIS-028 (Rev.1) (Part A)	Relevant clauses of AIS-028 (Rev. 1) (Part A)
10	Electrical wiring and harness		AIS 028
11	Non-moisture retaining hard rubber/equivalent material		AIS 028
12	Electrical fuses		AIS 028

* Certificate issued by accredited testing agency of the country of origin or a report issued by internationally accredited test laboratory may also be accepted.

- Note 1 - Only the standards, as amended from time to time, as mentioned above, shall be referred for compliance.
- Note 2 - Components downstream the Heat exchanger / vaporizer shall be considered as CNG components and prevailing Indian standard / ISO standard or equivalent standards shall be acceptable

APPENDIX – A.5

Labelling Requirement for dual fuel engines

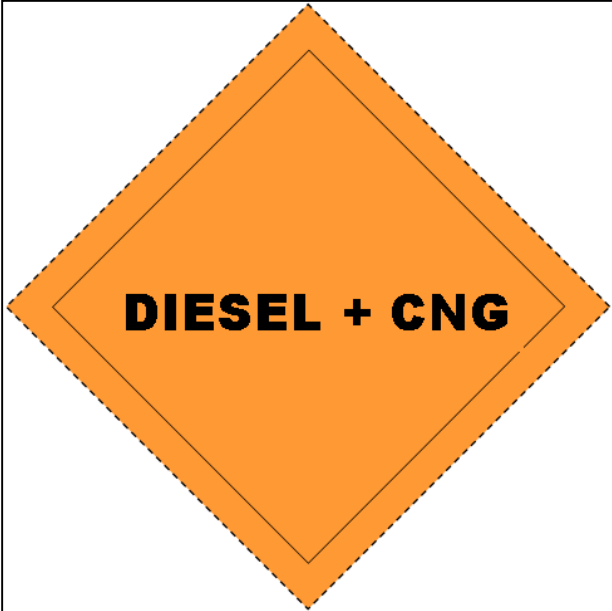
LABEL	
	
The sign consists of a sticker which shall be weather resistant.	
The colour and dimensions of the sticker shall fulfil the following requirements:	
Colors:	
Background:	Orange
Letters:	Black or black reflecting
Dimensions:	
Border width:	4 - 6 mm
Character height:	≥ 25 mm
Character thickness:	≥ 4 mm
Sticker width:	110 - 150 mm
Sticker height:	80 - 110 mm
<p>The word "DIESEL+CNG" shall be centred in the middle of the sticker. The sticker shall be pasted on Engine intake side or away from hot surface & it shall be clearly visible</p>	

ANNEXURE – 11

Composition of committee for formulation of this system & procedure

Planning & Co-ordination

Mr N K Gupta
Mr. Kedarnath Dash

Central Pollution Control Board, CPCB, New Delhi,

Co-ordinator

Dr. Prasanna G Bhat

The Automotive Research Association of India (ARAI), Pune

Members

Representative from

Representative from

Representative from

Representative from

Representative from

Representative from

Representative from

Representing

The Automotive Research Association of India (ARAI), Pune

International Centre for Automotive Technology (iCAT), Manesar, Gurgaon

Indian Diesel Engine Manufacturers' Association (IDEMA), New Delhi

Automotive Component Manufacturers Association of India (ACMA), New Delhi

Indian Institute of Petroleum (IIP), Dehra Dun

Emission Control Manufacturers Association (ECMA), New Delhi

Indian Oil Corporation Research and Development Centre, IOCL R&D, Faridabad

ANNEXURE – 12

India Genset Emission standards- IV+ Notification GSR copy as released

रविस्ट्री सं. डी.एल.- 33004/99

REGD. No. D. L.-33004/99

सत्यमेव जयते

भारत का राजपत्र The Gazette of India

सी.जी.-डी.एल.-अ.-04112022-240031
CG-DL-E-04112022-240031

असाधारण

EXTRAORDINARY

भाग II—खण्ड 3—उप-खण्ड (i)

PART II—Section 3—Sub-section (i)

प्राधिकार से प्रकाशित

PUBLISHED BY AUTHORITY

सं. 716]

नई दिल्ली, बृहस्पतिवार, नवम्बर 3, 2022/कार्तिक 12, 1944

No. 716]

NEW DELHI, THURSDAY, NOVEMBER 3, 2022/KARTIKA 12, 1944

MINISTRY OF ENVIRONMENT, FOREST AND CLIMATE CHANGE

NOTIFICATION

New Delhi, the 3rd November, 2022

G.S.R. 804(E).—Whereas, the Environment (Protection) Amendment Rules, 2022 were published in the Gazette of India, Extraordinary, Part II, Section 3, Sub-section (i), *vide* notification number G.S.R. 138 (E), dated the 18th February, 2022 inviting objections and suggestions from all persons thereby within a period of sixty days from the date on which copies of the Official Gazette containing the said notification were made available to the public;

And Whereas, copies of the Official Gazette containing the said notification were made available to the public on the 18th February, 2022;

And Whereas, objections and suggestions received from all persons and stakeholders in response to the said notification have been duly considered;

Now therefore, in exercise of the powers conferred by sections 6 and 25 of the Environment (Protection) Act, 1986 (29 of 1986) read with sub-rule (3) of rule 5 of the Environment (Protection) Rules, 1986, the Central Government hereby makes the following rules further to amend the Environment (Protection) Rules, 1986, namely: -

1. **Short title and commencement.**- (1) These rules may be called the Environment (Protection) Third Amendment Rules, 2022.

(2) They shall come into force from 1st July, 2023.

2. In the Environment (Protection) Rules, 1986, in the Schedule I,-

(a) in serial number 88,-

(i) item "A. Emission Standards" and entries relating thereto, the following shall be substituted, namely:-

"A. Emission Standards:

The emission limits for new engines used for power generating set (hereinafter referred to as Genset) applications up to 800 kW Gross Mechanical Power, namely:

- (i) Diesel engines;
- (ii) Engines based on dedicated alternate fuels;
- (iii) Engines based on Bi-fuels run either on Gasoline or on any one of the alternate fuels;
- (iv) Engines based on Dual Fuel run on Diesel and any of the alternate fuels;
- (v) Portable Generator sets (PI engines below 19kW and up to 800 cc displacement) run on Gasoline fuel, dedicated alternate fuels and Bi-fuel run either on Gasoline or on any one of the alternate fuels;

1. The emission limits for new engines up to 800 kW used for Genset shall be effective from 1st July, 2023 as specified in the Table 1 and Table 2 below subject to the General Conditions contained therein, namely:

TABLE 1

Emission limits for Genset engines up to 800 kW Gross Mechanical Powered by All CI engines and PI engines > 800 cc engine displacement.

Power Category, kW	NO _x	HC ^{*/**}	NO _x +HC ^{*/**}	CO	PM		Smoke (light absorption coefficient)	
					CI	PI	CI	PI
	CI/PI	CI/PI	CI/PI	CI/PI	CI	PI	m-1	
P ≤ 8	-	-	7.5	3.5	0.30	-	0.7	-
8 < P ≤ 19	-	-	4.7	3.5	0.30	-	0.7	-
19 < P ≤ 56	-	-	4.7	3.5	0.03	-	0.7	-
56 < P ≤ 560	0.40	0.19	-	3.5	0.02	-	0.7	-
560 < P ≤ 800	0.67	0.19	-	3.5	0.03	-	0.7	-

TABLE 2

Emission limits for portable Genset up to 19 kW powered by PI engines (up to 800 cc engine displacement)

Category Engine Displacement (cc)	CO	NOx +HC */**
	g/kWh	
Up to 99	< 250	< 10
> 99 and up to 225	< 250	< 08
> 225 and upto 800	< 250	< 06

The abbreviations used in Table 1 and Table 2 are as follows:

- (i) NOx – Oxides of Nitrogen;
 - (ii) HC– Hydrocarbon;
 - (iii) CO – Carbon Monoxide;
 - (iv) PM – Particulate Matter;
 - (v) CI-Compression Ignition engines;
 - (vi) PI- Positive Ignition engines;
 - (vii) * HC stands for THC for diesel and gasoline;
 - (viii) ** HC for alternate fuels shall be as defined in System and Procedure for Generator set.
2. Test cycle for constant speed and variable speed application shall be as described in System and Procedure for Genset.
3. Smoke shall not exceed prescribed limit value throughout the operating load points of the test cycle.
- Note: (i) The test shall be done on engine dynamometer for all CI engines and PI engines (above 800 cc displacement);
- (ii) the test shall be done on resistive load bank for Portable Gensets (up to 19 kW and up to 800 cc engine displacement) powered by PI engines;
- (iii) the emission limits are applicable to both constant speed and variable speed gensets and genset engines are used primarily to operate an electrical generator or alternator to produce and supply electric power for other applications in place of power from electric grid;
- (iv) portable genset combines an electrical generator and a prime mover engine to form a single piece of equipment. This combination engine-generator set can be moved, pulled and not attached to earth, by a person and not build permanently into a structure such as power house or station and satisfy the following conditions namely, -
- (a) power output is up to 19 kW and up to 800 cc engine displacement;
 - (b) power by PI air cooled engine;
 - (c) it is on Hand-cart mounted units.
- (v) the test procedure for measurement of gross power and the tolerances shall be as per procedure laid down in System and Procedure for Genset;
- (vi) administrative and test procedure for measurement of emission of visible and gaseous pollutant and particulate matter shall be as per procedure laid down System and Procedure for Genset;
- (vii) Table 1 and Table 2 emission limits shall be applicable for Type Approval Test and Conformity of Production Test as carried out by authorised certifying agencies;
- (viii) Frequency of Conformity of Production test and selection procedure shall be as per procedure laid down in System and Procedure for Genset;
- (ix) engine Durability Period and Deterioration Factor: Deterioration factor is applicable to all CI and PI engines above 19 kW power category only;
- (a) engine manufacturer may choose for an engine test laid down in System and Procedure for Genset as mentioned in Table 3 given below:

TABLE 3

Category (Power Band)	Emission durability period (hours)	Engine Category
>19 ≤ 56 kW (constant speed Engines)	3000	PI and CI
>19 ≤ 56 kW (Variable speed Engines)	5000	PI and CI
> 56 kW (All engines)	8000	PI and CI

- (b) as an alternative to use a service accumulation schedule to determine deterioration factors, engine manufacturers shall use the assigned multiplicative deterioration factors for engine families using exhaust after-treatment system as per the Engine Capacity mentioned in Table 4 given below:

TABLE 4

Engine Category	CO	HC	Nox	PM
CI	1.3	1.3	1.15	1.05
PI	1.3	1.3	1.15	-

- (c) Additive Deterioration Factors shall be specified by manufacturer with the supportive document as specified System and Procedure for Genset for each pollutant in an engine family approval application for CI engines and PI engines not using any exhaust after-treatment system;
- (d) manufacturers shall request type approval certification for shorter or longer useful life for an engine family and the test agency can approve a shorter or longer useful life in hours of engine operations but not in years.
- Engines rely on the external devices and/ or reagent in order to reduce emissions, shall ensure the correct operation of NOx control measures through Onboard Diagnostics as per procedure laid down in System and Procedure for Genset.
 - Emission of ammonia over the test cycles for engines equipped with Selective Catalytic Reduction shall not exceed a mean value of 25 part per million (ppm) for engine power category less than or equal to 56 kW and 10 ppm for engine power category above 56 kW.
 - Engines rely on the use of any external devices and /or exhaust after treatment device to reduce particulate matter emissions, shall ensure the correct operation of particulate matter control measures.
 - PI engines rely on the use of any external devices and /or exhaust after treatment device to reduce NOx emissions, shall ensure the correct operation of NOx control measures, as per procedure laid down in System and Procedure for Genset.
 - The NOx reduction reagent shall conform to standards determined in System and Procedure for Genset.
 - Specifications of test fuels for Type approval and Conformity of Production tests shall be as defined in System and Procedure for Genset and one emission compliance tests shall be carried either on commercially available fuel or with reference fuel as declared by the manufacture during type approval test application and the same to be followed during Conformity of Production compliance tests.
 - Stack height for Genset shall be governed as per Central Pollution Control Board guidelines.
 - Electronically controlled compression Ignition engines and dual fuel engines shall be within the control area regulated in System and Procedure for Genset and shall not exceed more than two times the limit values of the emissions specified in Table 1.;

(ii) item "C. General Conditions," and the entries relating thereto the following shall be substituted, namely: -

"C. General Conditions:

- Applicability.- These General Conditions shall apply to all new engines for power generation application and products manufactured, assembled or imported to India, operating at constant or variable speed as the case may be:

Provided that these rules, shall not apply to-

- engine or product, assembled or manufactured or imported, as the case may be, for the purpose of export outside India, or;
- engine or product intended for the purpose of sample limited to four in number and to be exported back within six months of completing the sample testing and not for sale in India.
- engine or product, assembled or manufactured or imported, as the case may be, for the purpose of research and development testing which shall be scraped or re-exported.

2. Requirement of certification.- Domestic manufacturer, importer or assembler of engines for power generation up to 800 kW and engine displacement > 800 cc and of portable Gensets up to 19 kW and engine displacement up to 800 cc, shall obtain Type Approval from authorised certifying agency and also comply with Conformity of Production test of their product(s) for the emission limits which shall be valid for the next Conformity of Production year or the date of implementation of the revised norms specified above, whichever is earlier.
Explanation. – The term Conformity of Production year covers the period from 1st July of calendar year to 30th June of the following calendar year.
3. Sale, import or use of engine or product not complying with these rules.- No person shall sell, import or use an engine and genset for power generation application which is not having a valid Type Approval certificate and certificate of Conformity of Production referred to in General Condition 2.
4. Requirement of conformance labelling shall be as mentioned in System and Procedure for Genset.
5. Nodal Agency. – The Central Pollution Control Board shall be the nodal agency for implementation of these rules.
 - (a) In case of difficulty in implementation of these rules, the matter shall be referred to the nodal agency.
 - (b) shall constitute a Standing Committee to advise it related to the implementation of these rules.
6. Authorised agencies for certification. – (a) Automotive Research Association of India, Pune (Maharashtra); (b) International Centre for Automotive Technology, Manesar (Haryana); and (c) Indian Institute of Petroleum, Dehradun (Uttarakhand) are authorised to carry out or witness such tests as they may deem necessary, for giving certificates of Type Approval and Conformity of Production for engines and Gensets for power generation application. -
7. Compliance and testing procedure.-
 - (1) the Compliance and Testing Procedure, as published by the Central Pollution Control Board shall be followed by all concerned,
 - (2) the authorised agencies for certification shall submit the testing and certification details in respect of the emission to the Central Pollution Control Board annually.
8. Engine components or parts identification.- All the details of engine components or parts responsible for the emission performance shall be clearly marked in English language.
9. Safety code of practices for alternate fuels shall be as defined in System and Procedure for Genset.

10. Fuel system components certification for alternate fuels shall be as defined in System and Procedure for Genset.
11. The Central Pollution Control Board, Commission for Air Quality Management, State Pollution Control Boards or Pollution Control Committee may issue more stringent norms taking account to local condition of the area.
12. Transition provisions for Gensets and Genset engines manufactured as per earlier norms shall be as defined as follows:
 - (a) Last date of manufacturing of engine system as per earlier norms shall be 30th June 2023. For PI engines it shall be 31st July 2023.
 - (b) Last date of manufacturing of Gensets as per earlier norms shall be 31st December 2023.
 - (c) Last date of manufacturing of PI Gensets as per earlier norms shall be 31st August 2023.;
 - (b) serial number 95 and the entries relating thereto shall be omitted;
 - (c) in serial number 95 A,-
 - (i) item "A. Emission Limits" and the entries relating thereto shall be omitted;
 - (ii) item "C. General Conditions" and the entries relating thereto shall be omitted;
 - (d) in serial number 95 B,-
 - (i) item "A. Emission Limits" and the entries relating thereto shall be omitted;
 - (ii) item "C. General Conditions" and the entries relating thereto shall be omitted;
 - (e) in serial number 95 C,-
 - (i) item "A. Emission Limits" and the entries relating thereto shall be omitted;
 - (ii) item "C. General Conditions" and the entries relating thereto shall be omitted.

[F.No. Q-15017/05/2012-CPW]

NARESH PAL GANGWAR, Addl. Secy.

Note: The principle rules were published in the Gazette of India, Extraordinary, Part II, Section 3, Sub-section (i), *vide* number S.O. 844(E), dated the 19th November, 1986 and lastly amended, *vide* notification G.S.R. 682(E), dated the 5th September, 2022.

****END****

This page intentionally kept blank

Part - A2

Positive Ignition (PI) Engines

1. SCOPE

This **A2** document lays down the applicability and requirements, system & procedure for compliance to the rules vide notification no. GSR 804(E.) dated 3-Nov-2022 on emission limits for new internal combustion engine up to 800 kW gross power used for power generating set (Genset) application, issued by Ministry of Environment, Forests & Climate change, Government of India.

Emission of gaseous CO, HC and NOx from following type of positive ignition internal combustion engines operating with either constant speed duty cycle,

- Dedicated alternate fuels*
- Bi-fuel run either on Gasoline or on any one of the alternate fuels*

*Alternate fuels - Natural Gas/Bio methane, Bio-gas, LPG, Ethanol blended gasoline (E10, E12, E15, E20, E85) Ethanol E100, Methanol blended gasoline (M15, M85), Methanol M100, Hydrogen, Hydrogen blended with CNG (18% hydrogen), Bio-diesel (B7/B8 to B20, B100) (Fuel Specification of these fuels shall be as notified under CMVR as amended from time to time)

Natural Gas can be used in the form of Compressed Natural Gas or Liquefied Natural Gas or Piped Natural Gas.

Following parts of specified standards shall be referred wherever stated.

Sr No.	Standard	Title
1	ISO 8178-1: 2017 ISO 8178-1: 2020	Reciprocating internal combustion engines — Exhaust emission measurement — Part 1: Test-bed measurement systems of gaseous and particulate emission
2	ISO 8178-3: 2019	Exhaust emission measurement — Part 3: Test procedure for measurement of exhaust gas smoke emissions from compression ignition engines using a filter type smoke meter
3	ISO 8178-4: 2017 ISO 8178-4: 2020	Reciprocating internal combustion engines — Exhaust emission measurement — Part 4: Steady-state and transient test cycles for different engine application
4	ISO 8178-7: 2015	Reciprocating internal combustion engine-Exhaust emission measurement-Part-7: Engine family determination
5	ISO 8178-9: 2019	Reciprocating internal combustion engines — Exhaust emission measurement — Part 9: Test cycles and test procedures for measurement of exhaust gas smoke emissions from compression ignition engines using an opacimeter
6	40 CFR Part 1039	US EPA Regulation: 40 CFR Part 1039 - Control of emissions from new and in-use nonroad compression-ignition engines
7	40 CFR Part 1065	US EPA Regulation: 40 CFR Part 1065 – Engine testing procedures
8	AIS 024 (Version 5)	Safety and Procedural requirements for type approval of CNG/Bio-CNG/LNG operated vehicles (dedicated, bi-fuel & dual fuel)
9	AIS 028 (Version 5)	Code of practice for use of CNG/Bio-CNG/LNG fuel in internal combustion engine vehicles

2. DEFINITION & ABBREVIATIONS

2.1 DEFINITIONS

1. **“Approval of an engine (engine family)”** means the approval of an engine type with regards to the level of the emission of gaseous pollutants;
2. **“Auxiliary emission control strategy”** means any element of design that senses temperature, engine RPM, or any other parameter for the purpose of activating, modulating, delaying, or deactivating the operation of any part of the emission control system;
3. **“Adjustment factors”** mean additive (upward adjustment factor and downward adjustment factor) or multiplicative factors to be considered during the periodic (infrequent) regeneration;
4. **“Ageing cycle”** means the machine or engine operation (speed, load, power) to be executed during the service accumulation period
5. **“Applicable emission limit”** means an emission limit to which an engine is subject to for approval;
6. **“Approval of an engine”** means the approval of an engine type or family with regard to the level of emission of gaseous pollutants by the engine;
7. **“Base emission control strategy”** means design strategy that is active throughout the speed and load operating range of engine unless Auxiliary emission control is activated;
8. **“Compressed natural gas (CNG / BIO CNG)”** means a compressed gaseous fuel composed predominantly of Methane (CH₄) shall be used as specified by the Government of India from time to time.
9. **“Confirmed and active DTC”** means a DTC that is stored during the time the NCD system concludes that a malfunction exists;
10. **“Constant speed engine”** means an engine whose type approval or certification is limited to constant-speed operation. Engines whose constant-speed governor function is removed or disabled are no longer constant-speed engines;
11. **“Constant speed operation”** means engine operation with a governor that automatically controls the operator’s demand to maintain engine speed, even under changing load. Governors do not always maintain exactly constant speed, but shall be maintained with allowed tolerances as mentioned in the document”
12. **“Critical emission related components”** means the components which are designed primarily for emission control, that is, any exhaust after-treatment system, the electronic engine control unit and its associated sensors and actuators, fuel injection equipment, turbocharger and its integral control actuators and the EGR system including all related filters, coolers, control valves and tubing;
13. **“Critical emission related maintenance”** means the maintenance to be performed on critical emission-related components;
14. **“De-NO_x system”** means an exhaust after-treatment system designed to reduce emissions of oxides of nitrogen (NO_x) (e.g. passive and active lean NO_x catalysts, NO_x absorbers and selective catalytic reduction (SCR) systems);
15. **“Diagnostic trouble code – DTC”** means a numeric or alphanumeric identifier which identifies or labels related to emission

16. **“Discrete mode”** means relating to a discrete mode type of steady-state test, as described in ISO 8178-4.
17. **“Emissions-related defect”** means a deviation from normal production tolerances in design, materials, system or assembly that affects any parameter, specification or component belonging to the emission control system. A missing component may be considered to be an emission-related defect;
18. **“Emission control system”** means the exhaust after treatment system including, the electronic management controllers of the engine system (if utilized) and any emission related component of the engine system in the exhaust which supplies an input to or receives an output from these controllers and when applicable the communication interface between the engine system electronic control unit (ECU) and any other power train with respect to emissions management;
19. **“Engine system”** means the engine, the emission control system and the communication interface (hardware and messages) between the engine system electronic control unit (ECU) and any other power train;
20. **“Engine family”** means a manufacturer’s grouping of engine systems which, through their design have similar exhaust emission characteristics, all members of the family must comply with the applicable emission limit values described in Clause 3.1. Also refer ISO 8178-7;
21. **“Engine type”** means a category of engines, which do not differ in such essential respects as engine characteristics as defined in ISO 8178-7
22. **“Exhaust after treatment system”** means ‘a catalyst (oxidation or 3-way), a particulate filter, a de-NOx system, a combined de-NOx particulate filter’ or any other emission-reducing device that is installed downstream of the engine. This definition excludes exhaust gas recirculation, which, where fitted is considered an integral part of the engine system;
23. **“Engine governed speed”** means the engine operating speed when it is controlled by the installed governor;
24. **“Electronically controlled engines”** means the engines using electronic control to determine both the quantity and timing of injecting fuel.
25. **“Electronic control unit (ECU)”** means an engine’s electronic device that uses data from engine sensors to control engine parameters as primary function. ECU may contain more functionality than stated above of interest;
26. **“Emission control strategy”** means a combination of an emission control system with one base emission control strategy and with one set of auxiliary emission control strategies, incorporated into the overall design of an engine or Genset into which the engine is installed;
27. **“Emission durability period”** mean the number of hours indicated in Appendix 6 of Annexure 7 used to determine the deterioration factors
28. **“Emission related maintenance”** means maintenance which substantially affects emissions, or which is likely to affect emissions performance deterioration of the vehicle or the engine and exhaust after treatment system during normal in-use operation;
29. **“Engine-after treatment system family”** means a manufacturer’s grouping of engines that complies with the definition of engine family, but which are further grouped into a family of engine families utilising a similar exhaust after-treatment system;
30. **“Exhaust gas recirculation”** means a technology that reduces emissions by routing exhaust gases that have been exhausted from the combustion chamber(s) back into the engine to be mixed with incoming air before or during combustion. The use of valve timing to increase the amount of residual exhaust gas in the combustion chamber(s) that is mixed with incoming air before or during combustion

(also called 'internal EGR') is not considered exhaust-gas recirculation for the purposes of this Regulation;

31. **For Domestic products**, Date of Manufacture means the date on which the engine or genset is invoiced;
32. **For Imported products**, Date of Import means the date of payment of custom duties applicable to the engine or Genset;
33. **“Genset Engine”** means engines used primarily to operate an electrical generator / alternator to produce and supply electric power for other applications in lieu of supply of power from electric grid;
34. **“Gaseous pollutant”** means carbon monoxide (CO), hydrocarbons (HC – assuming a ratio of $C_1H_{1.85}$) and oxides of nitrogen (NO_x), the last named being expressed in nitrogen dioxide (NO₂) equivalent;
35. **“High idle speed”** means ‘the speed achieved by the engine under the specified test conditions at full throttle with no external load applied on the engine flywheel
36. **“Hydrocarbon (HC)”** means Total Hydrocarbon (THC), non-methane hydrocarbon (NMHC) as applicable. Hydrocarbon generally means the hydrocarbon group on which the emission standards are based for each type of fuel and engine
37. **Internal combustion engine (ICE)”** means an engine, which works on the either compression-ignition principle or positive ignition principle utilising liquid, gaseous or combination of both fuels;
38. **“Idle speed”** means the lowest engine speed with minimum load (greater than or equal to zero load), where an engine governor function controls engine speed. For engines without a governor function that controls idle speed, idle speed means the manufacturer-declared value for lowest engine speed possible with minimum load. Note that warm idle speed is the idle speed of a warmed-up engine.
39. **“Liquefied Natural Gas (LNG)”** means a Natural gas that has been cooled to -259 degrees Fahrenheit (-161 degrees Celsius) and at which point it is condensed into a liquid which is colourless, odourless, non-corrosive and non-toxic. Characterized as a cryogenic liquid. Fuel quality for GENSET use shall meet the requirements of BIS specification as notified from time to time by MoPNG, Govt. of India.
40. **“Manufacturer”** means engine or Genset manufacturer, importer or, assembler (as noted in notification);
41. **“NCD engine family”** means a manufacturer’s grouping of engine systems having common methods of monitoring/diagnosing NCMs;
42. **“NO_x control diagnostic system (NCD)”** means system on-board the engine which has the capability” of: Detecting a NO_x control malfunction; Identifying the likely cause of Nox control malfunctions by means of information stored in computer memory and/or communicating that information off-board;
43. **“NO_x control malfunction (NCM)”** means an attempt to tamper with the Nox control system of an engine and/or exhaust after treatment system or a malfunction affecting that system that might be due to tampering, that is considered by this Regulation as requiring the activation of a warning or an inducement system once detected;
44. **“Non-emission related maintenance”** means maintenance which does not substantially affect emissions, and which does not have a lasting effect on the emissions performance deterioration of the machine or the engine during normal in-use operation once the maintenance is performed;
45. **“Non-methane hydrocarbons (NMHC)”** means the sum of all hydrocarbon species except methane;
46. **“Non-Methane Organic Gas (NMOG)”** means the sum of non-oxygenated and oxygenated hydrocarbons contained in a gas sample

47. **“Oxides of Nitrogen (NO_x)”** means compounds containing only nitrogen and oxygen as measured by the procedures specified in this Regulation. Oxides of nitrogen are expressed quantitatively as if the NO is in the form of NO₂, such that an effective molar mass is used for all oxides of nitrogen equivalent to that of NO₂.
48. **“Open crankcase emissions”** means any flow from an engine’s crankcase that is emitted directly into the environment;
49. **“Operator demand”** means an engine operator’s input to control engine output. The “operator” may be a person (i.e. manual), or a governor (i.e., automatic) that mechanically or electronically signals an input that demands engine output. Input may be from an accelerator pedal or signal, a throttle-control lever or signal, a fuel lever or signal, a speed lever or signal, or a governor set-point or signal
50. **“Percent load”** means the fraction of declared rated torque at an engine speed;
51. **“Placing on the market”** means the action of making available a product covered by this Regulation on the market of a country applying this Regulation, for payment or free of charge, with a view to distribution and/or use in the country
52. **“Parent engine”** means an engine selected from an engine family in such a way that its emissions characteristics will be representative for that engine family and that it complies with the requirements set out in ISO 8178-7
53. **“Power generating set or Genset”** means any equipment which is used for electric power generation in absence or failure of grid power utilizing engine system defined in this document as prime mover;
54. **“Rated power”** means nominal power in kW declared by manufacturer at declared rated Speed
55. **“Rated speed”** is the engine speed at which the declared rated power occurs with allowed tolerances as mentioned in the document"
56. **“Ramped modal steady-state test cycle”** means a test cycle with a sequence of steady state engine test modes with defined speed and torque criteria at each mode and defined speed and torque ramps between these modes
57. **“Scan tool”** means an external test equipment used for off-board communication with NCD system;
58. **“Service accumulation schedule”** means the aging cycle and the service accumulation period for determining the deterioration factors for the engine-after treatment system family;
59. **“Total hydrocarbon (THC)”** means the combined mass of organic compounds measured by the specified procedure for measuring total hydrocarbon, expressed as a hydrocarbon with a hydrogen-to-carbon mass ratio of 1.85:1;
60. **“Test Cycle”** means a sequence of test points each with a defined speed and torque to be followed by the engine during standardised emission assessment test. Also refer ISO 8178-4;
61. **“Type approval”** means the approval of an engine type with regard to its emissions measured in accordance with the procedures specified in this Regulation;

2.2 Abbreviations

BSFC	Brake-specific fuel consumption
BIS	Bureau of Indian Standards
CPCB	Central Pollution Control Board
C ₁	Carbon 1 equivalent hydrocarbon
CC	Cubic Centimetre
CH ₄	Methane
C ₂ H ₆	Ethane
C ₃ H ₈	Propane
CNG	Compressed Natural Gas
CO	Carbon monoxide
CO ₂	Carbon dioxide
COP	Conformity of Production
COP-Year	Period starting 1 st July of year till 30 th June of subsequent year
CI	Compression-ignition (Engine)
De-NO _x	NO _x after-treatment system
DF	Deterioration factor
ECM	Electronic control module
EGR	Exhaust gas recirculation
FBC	Fuel borne catalyst (for soot regeneration)
FID	Flame Ionization Detector
GOEM	Genset Original Equipment Manufacturer
HC	Hydrocarbon
H ₂ O	Water
ISO	International Organization for Standardization
LPG	Liquefied Petroleum Gas
LNG	Liquefied Natural Gas
NMHC	Non-methane hydrocarbon
NMOG	Non-Methane Organic Gas
NO _x	Oxides of nitrogen
NO	Nitric oxide
NO ₂	Nitrogen di oxide
O ₂	Oxygen
PI	Positive Ignition (Engine)
PPM	Part per million
RHC	Reactive Hydrocarbon
RMS	Root-mean square
S	Sulphur
THC	Total Hydrocarbon

3 Exhaust Emission Limits, Applicability and Requirement

3.1. Exhaust Emission Limits

The emissions of the carbon monoxide, the emissions of non-methane hydrocarbons / reactive hydrocarbon / Non-Methane Organic gas, and the emissions of the oxides of nitrogen during emission certification and conformity of production emission test/s conducted in accord with in Annexure 7 of this regulation considering applicable deterioration factor, adjustment factor, shall not exceed the amount shown in Table 1 below:

Table 1
Emission limits for Genset engines up to 800 kW Powered by PI engines

Power Category, kW	Ignition type	NOx	HC	NOx +HC	CO
P ≤ 8	PI	-	-	7.5	3.5
8 < P ≤ 19	PI	-	-	4.7	3.5
19 < P ≤ 56	PI	-	-	4.7	3.5
56 < P ≤ 560	PI	0.40	0.19	-	3.5
560 < P ≤ 800	PI	0.67	0.19	-	3.5

Speed operation	Emission Test Cycle
Constand speed engine	D1 3-mode Steady-state discrete mode test cycle specified in ISO-8178-Part 4 OR D1 3-mode Steady-state ramped mode test cycle specified in ISO-8178-Part 4
<i>Manufactures shall declare in TA application his choice of discrete-mode type or RMC type cycle for each family. The chosen cycle type shall also be applicable for all the child rating within family and not allowed to alter or further choice during COP.</i>	

Notes:

- The above limits are applicable for constant speed
- Every manufacturer, importer or assembler (hereafter referred as manufacturer) of the engine for genset application manufactured or imported into India shall obtain Type Approval and comply with Conformity of Production (COP) requirements of their product(s) for emission limits which shall be valid for next COP year.
- The above-mentioned limit shall be applicable to Type approval and Conformity of Production (COP) carried out by authorized test agencies.
- The term 'COP year' means the period from 1st July of a calendar year to 30th June of the following year
- HC* - NMHC shall be considered for natural gas or RHC in case of LPG or NMoG in case of alcohol-based fuels

Note:

NMHC = THC – CH₄ for natural gas operation
RHC = 0.5 X THC for LPG operation

3.2. Rounding off

Determine the official emission result for each pollutant to at least one more decimal place than the applicable standard. Apply the deterioration factor to the official emission result, then round the adjusted figure to the same number of decimal places as the emission standard. Compare the rounded emission levels to the emission standard for each emission-data engine. In the case of NOX+NMHC standards, apply the deterioration factor to each pollutant and then add the results before rounding. Test report shall have both, the final rounded certificate emission result and adjusted test result before rounding for better clarity on the decision.

Use the following rounding convention

- i. If the first (left-most) digit to be removed is less than five, remove all the appropriate digits without changing the digits that remain. For example, 3.141593 rounded to the second decimal place is 3.14.
- ii. If the first digit to be removed is greater than five, remove all the appropriate digits and increase the lowest-value remaining digit by one. For example, 3.141593 rounded to the fourth decimal place is 3.1416.
- iii. If the first digit to be removed is five with at least one additional non-zero digit following the five, remove all the appropriate digits and increase the lowest-value remaining digit by one. For example, 3.141593 rounded to the third decimal place is 3.142.
- iv. If the first digit to be removed is five with no additional non-zero digits following the five, remove all the appropriate digits, increase the lowest-value remaining digit by one if it is odd and leave it unchanged if it is even. For example, 1.75 and 1.750 rounded to the first decimal place are 1.8; while 1.85 and 1.850 rounded to the first decimal place are also 1.8. Note that this rounding procedure will always result in an even number for the lowest-value digit.

Examples-

#	1	2	3	4	5	5	5	6	
1	Measured value – PM	0.0047	0.0048	0.0142	0.0143 (odd)	0.0238 (even)	0.0239	0.0333	0.0334
2	Emission Limit – PM	0.02	0.02	0.02	0.02	0.02	0.02	0.02	0.02
3	DF applicable	1.05	1.05	1.05	1.05	1.05	1.05	1.05	1.05
4	DF incorporated adjusted emission	0.0049	0.0050	0.0149	0.0150	0.0250	0.0251	0.0350	0.0351
5	Final certificate emission value	0.00	0.01	0.01	0.02	0.02	0.03	0.03	0.04
6	Decision Pass/Fail	Pass	Pass	Pass	Pass	Pass	Fail	Fail	Fail

Note: Rounding Reference taken form US EPA Regulation 40 CFR -1039 and 40 CFR- 1065

3.3 In addition, the following requirements shall apply:

- a) **Ammonia emission** over the test cycles for engines equipped with SCR shall not exceed a mean value of 25 ppm for engine power category less than or equal to 56 kW and 10 ppm for engine power category above 56 kW as set out details in Appendix 7 of Annexure 7 of this Regulation
- b) **Engine Durability Period and Deterioration Factor** shall be applicable to above 19 kW power category only as set out in details in Appendix 6 of Annexure 7 of this Regulation in details.

Engine Durability Period

Category (Power Band)	Emission durability period (hours)
>19 ≤ 56 kW (constant speed Engines)	3000
> 56 kW (All engines)	8000

Note: DF determined during type approval will be carried over.

Category (Power Band)	Deterioration Factors (DF)		
	CO	HC	NOx
>19 kW (Constant Speed Engine)	1.3	1.3	1.15

Assigned multiplicative deterioration factors

Note: When opted for assigned multiplicative DF, no verification is required.

c) **Reserved**

- d) **Gross Power & Speed tolerance:** The gross declared power of the engine shall be measured on the test bench at rated speed of engine. The measured power and speed may differ from the power and speed declared by manufactured as specified below.

Case	Gross Power Tolerance	Speed Tolerance
	Constant speed	Constant speed
Type Approval	± 5% at rated for single cylinder engines ± 4% at rated for others engine	± 1% at rated
CoP	± 6% at rated for single cylinder engines ± 5% at rated for others engine	

- e) **Crankcase ventilation requirement** shall be applicable to above 56 kW power category engines as set out details in Appendix 5 of Annexure 7 of this Regulation
- f) **Control Conditions-Altitude, Temperature:** Electronically controlled engine using auxiliary emission control strategy shall demonstrate the compliance requirement over control conditions at type approval as set out details in Annexure 8 of this Regulation. This clause is applicable to for power band above 56 kW electronically controlled engine using auxiliary emission control strategy to operate in altitude.

Summary of the requirement:

Requirement	Power Category, kW		
	P ≤ 19	19 < P ≤ 56	56 < P ≤ 800
Deterioration Factors (DF)	N/A	Yes	Yes
Crankcase emission	N/A	N/A	Yes
Ammonia emission	Yes ^a	Yes ^a	Yes ^a
Control conditions-Altitude, Temperature	N/A	N/A	Yes ^b

^a Applicable SCR engine using reagent to reduce NOx emissions

^b Applicable for electronically controlled engine using auxiliary emission control strategy to operate in altitude. Demonstration is only at time of type approval only once and not applicable during COP.

4 Type Approval Administrative Procedure

4.1 Engine type and Engine family

4.1.1. Engine type

The technical features of an engine type shall be those defined in its information document drafted in accordance with the template set out in Annexure 1.

4.1.2. Operating mode (speed operation)

An engine type may be type-approved as a constant speed engine, as defined of this Regulation.

4.1.2.1. Reserved

4.1.2.2. Constant speed engines

The manufacture shall declare in his application the operation of engine is constant speed.

4.1.2.3. Constant speed engine types equipped with alternative rated speeds

A constant speed engine shall not be designed to operate with variable speed. In the case that the engine type is equipped with alternative speeds the requirements of this paragraph shall additionally be met.

In the case that the engine type is the parent engine, the engine shall meet the applicable limit values when tested using the applicable constant speed test cycle at each constant speed applicable to the engine type. Separate test reports shall be produced and included in the information package for each emission test.

In the case of all engine types within the engine family, when subject to a conformity of production emissions test the engine shall meet the applicable limit values using the applicable constant speed test cycle at each constant speed applicable to the engine type.

Each constant speed applicable to the engine type that is permitted by the manufacturer shall be listed in information document as per Annexure 1

The engine shall be installed in a manner to ensure that:

- (a) the engine is stopped prior to resetting the constant speed governor to an alternative speed; and,
- (b) the constant speed governor is only set to the alternative speeds permitted by the engine manufacturer.

The instructions to the GOEM and end-users set out in Appendices A.1 and A.2 to Annexure 9 of this Regulation shall include information on the correct installation and operation of the engine according to the requirements of this Annexure.

4.1.3. Engine family criteria

4.1.3.1. General

For the purpose of type approval and conformity of production certification, the manufacturer engine range shall be divided into model families consisting of parent engine and its variant(s).

In case of import of complete genset, all the provision of this document shall be applicable to the engine which form part of the genset.

Engine family shall be the grouping of engines, which through their design are expected to have similar exhaust emission characteristic where member of the family shall comply with the applicable emission values.

Parent engine shall be the engine selected from the engine family, in such a way that it will incorporate those features which will adversely affect the emission level of the relevant exhaust emission.

4.1.3.2. **Engine family formation & choice of the parent engine**

Essential characteristic of the engine family, the parameters defining the engine family, the determination of an engine family and the criteria for choosing the parent engine shall be taken according to the guideline given in ISO 8178-7 Reciprocating internal combustion Engine-Exhaust Emission Measurement-Part-7: Engine family determination. However, the decision of selection of parent engine and family classification by the authorized test agency shall be final.

For the purpose of identification, the manufacturer shall designate the families as F1, F2, F3.... Fn.

The manufacturer shall provide to the type approval authority the appropriate information relating to the emissions levels of the members of the engine family

4.1.3.3. **Reserved**

4.2 Selection of Certifying Agency

4.2.1. Following test agencies are currently approved by the Nodal Agency Central Pollution Control Board (CPCB) for purpose of type approval and subsequently conformity of production compliance process and may be revised from time to time.

- (a) Automotive Research Association of India (ARAI, Pune)
- (b) International Centre for Automotive Testing (ICAT, Manesar)
- (c) Indian Institute of Petroleum (IIP, Dehradun)

4.2.2. One supplier shall submit application for Type Approval to only one certification agency for all its families / models out of those approved.

4.2.3. The same certification agency shall be responsible for carrying out the verification of Conformity of Production (COP) for that manufacture

4.2.4. For a new OEM or importer, selection of technical agencies for type approval certification and subsequently conformity of production shall be applicant's choice among the technical agencies published by central pollution control board (CPCB) in paragraph 4.2.1 and as amended from time to time.

4.2.5. For any reason if any manufacturer wants to change the certification agency, he shall apply to the nodal agency well in advance with justifiable reason. The nodal agency, after consultation with the existing certification agency/ standing committee, may approve the change, if found justified. If approved, the nodal agency shall inform to the parties concerned.

4.2.6. On receipt of information for change in certification agency from the nodal agency, the previous certification agency shall authenticate all the relevant document of the model (type approval as well as COP verification) and forward the same to the new certification agency. The certification agency shall be responsible for carrying out the type approval testing and COP verification for the manufacturer, in future.

4.3 Application of type approval

4.3.1 The application shall be made in the format prescribed in **Appendix -1** and must be complete in all respect. **Appendix -1** shall be submitted to nodal agency and on its written acceptance, engine specification related documents to be submitted to the test agency.

4.3.2 The application for approval of an engine or an engine family with regard to the level of the emission of gaseous pollutants shall be submitted by the engine manufacturer or by a duly accredited representative.

4.3.3 For each engine family, the manufacturer must submit an application to the certification agency,

selected as above.

4.3.4 The application must be signed by the authorized representative of the manufacturer.

4.3.5 It shall be accompanied by the undermentioned documents and the following particulars:

A description of the engine type comprising the particulars referred to in clause 4.1. of this Regulation and if applicable the particulars of the engine family as referred to in paragraph 4.1.3. to this Regulation. For the purpose of identification, the manufacturer shall designate the engines families as F1, F2, F3 Fn in consultation with technical agency;

4.3.6 Testing of the parent model, shall, normally, be sufficient for type approval of the family. The Testing agency has the option to carry out the testing of more than one model in the family to satisfy itself, subject to parent engine-concept as per ISO 8178-7

4.3.7 An engine conforming to the engine type characteristics described in clause 4.1. shall be submitted to the Test Agency responsible for conducting the approval tests. If the Test Agency determines that the submitted engine does not fully represent the engine family described in clause 4.1, an alternative and, if necessary, an additional engine shall be submitted for test

4.3.8 During Type Approval test, the manufacturer shall submit the qualified emission test data of all the remaining variant engines, other than the parent engine, which is chosen for emission test by the test agency of the family along with all other documents. Qualified emission data can be an emission test recorded at OEMs facility. This is required only for reference of test agency for future COP testing and it will not be part of Type Approval certification documents.

4.3.9 At later stage if the manufacturer submits the application for type approval of a model, the Testing agency shall ascertain whether the model can be classified as belonging to a family of model(s) already certified. If the model does not belong to a family already certified, the Testing agency shall proceed with the testing of the model for type approval with issuance of new and unique engine emissions family certification upon qualification;

4.3.10 If the model belongs to a family already certified, the Testing agency shall decide whether the specific testing of the model is required. In case the specific testing of the model is not required, the type approval certificate for the family may be extended to include the model. In such case qualified emissions data shall be submitted to agency by manufacturer during application;

4.3.11 The Testing agency shall intimate its decision to the applicant within a fortnight of receipt of the application, indicating need and plan (schedule) of testing for type approval;

4.4 Type Approval

4.4.1. No person or agency shall sale, import or use an engine for Genset application in India without valid Type Approval Certificate and Conformity of production Certificate referred to in clause 4.5. and 5.4 of this Regulation;

4.4.2. No person or agency shall sale, import or use a Genset in India containing an Engine without valid Type Approval Certificate and Conformity of production Certificate referred to in Clause 4.5. and 5.4 of this Regulation;

4.4.3. In order to receive a type approval of an engine type or engine family, the manufacturer shall demonstrate compliance, of the engine type or engine family with the provisions of this Regulation. The manufacturer shall also ensure the use of fuels as specified in Annexure 6.

4.4.4. All the type approval tests shall be conducted in the technical agency laboratory. In case the required test facilities are accredited by the technical agency, the type approval and / or COP tests can be carried out at manufacturer's laboratory also if reasons call for. In case the test is to be carried out at any overseas test facilities, the same shall be informed to the Nodal Agency by

technical agency. The technical agency will submit a copy of accreditation letter highlighting the details of test facilities available in the manufacturer's laboratory to the Nodal Agency;

- 4.4.5. In case of the manufacturer approaches the technical agency for the first time, such manufacturer should complete the COP test(s) within three months from the commencement of commercial production or importation of 100 units.
- 4.4.6. The manufacturer may use of commercial fuels or reference fuels set out in Annexure 6, provided to be declared in the information document.
- 4.4.7. Additionally, in order to receive type approval of a Genset with an approved engine with regard to emissions or a type approval of a Genset with regard to emissions the manufacturer shall ensure compliance with the installation requirements set out in Annexure -9
- 4.4.8. The Type Approval Authority shall put together an information package consisting of the information folder accompanied by the test report and all other documents added by the technical service or by the Type Approval Authority to the information folder in the course of carrying out their functions ('the information package'). The information package shall include an index listing its contents, suitably numbered or otherwise marked so as to clearly identify all the pages and the format of each document, in order to present a record of the successive steps in the management of the type approval, in particular the dates of revisions and updating;
- 4.4.9. The approval authority shall ensure that the information contained in the information package is available for a period of at least 10 years following the end of the validity of the type approval concerned;

4.5 Certificate of Type Approval and Validity

- 4.5.1. After verification of engine(s) for the type approval, the technical agency shall issue a type approval report to manufacturer within one month from date of testing completion indicating acceptance or rejection decision and reason thereof. If the engine(s) submitted for approval pursuant to clause 4.3. of this Regulation. Approval of that engine type(s) or engine family(ies) shall be granted by the technical agency through issue of Type Approval Certificate as per format prescribed in Annexure 2 along with report. Copy of the certificate and report shall be forwarded to Nodal Agency by technical agency involved;
- 4.5.2. For the purposes of clarity and easing access to relevant data, the communication includes an addendum containing the most relevant information related with the type-approved engine type or engine family;
- 4.5.3. The certificate shall be deemed to be valid for the model(s) included herein, unless explicitly withdrawn by separate written order by the Nodal Agency;
- 4.5.4. The Type Approval certificate for an engine family issued to the manufacturer shall be valid for the same model(s) manufactured at any other manufacturing plant of the same manufacturer. The Nodal Agency or technical agency concern with type approval may visit the new plant to verify adequacy of the infrastructure;
- 4.5.5. Validity of Type Approval Certificate issued by type approval authority shall remain valid for 'current' COP-year enabling sales of such type approved engine family for that duration;
- 4.5.6. Validity of Type Approval Certificate issued by type approval authority shall remain valid further as long as following conditions are met:
 - j) Till the engine specifications change as mentioned in Annexure 1 and modification related clauses described in clause 4.6 below;
 - ii) Till the further amendments to the notification;
 - iii) Till COP is not missed / Till COP procedure compliance per clause 5 is obtained within prescribed timeframe as listed in clause 5.3.10.
- 4.5.7. In case manufacturer has not sold engines in two subsequent COP-year period and has done appropriate 'Zero volume' declaration seeking COP exemption to nodal agency, and for resuming sale for third year of such engine family, manufacturer to conduct COP test before making any

sell or a fresh new type approval application and subsequent process needs to be carried out. Refer clause 5.5 for COP certification.

4.6 Modification and Extensions of approved type

- 4.6.1. If an engine type or engine family is type approved and valid, manufacturer may approach type approval certificate issuing technical agency for modifications pertaining to parent or any engine type in the certified engine emissions family. Such modifications shall be ascertained by manufacturer utilizing guidelines described in clause 4.6.5
- 4.6.2. Manufacturer shall submit technical document in line with type approval procedure prescribed in this Regulation;
- 4.6.3. Subjected to scrutiny of manufacture's application, technical agency shall approve or seek more data pertaining but not limited to engine architecture, parameters, similarity with existing engine type from emissions and performance perspective along with evidences. Decision of technical agency will remain finally binding for allowing such amendments to existing type approval certificate of an engine family through extension(s) vs asking manufacturer to type approve as new engine family or new engine type;
- 4.6.4. Technical agency retains all rights to ask manufacture to demonstrate modified engine type for emissions conformity through applicable type approval test procedures. Submission of manufacturer run emissions data with valid test facility and procedure followed is mandatory where changes are directly or indirectly pertaining to emission affecting components, engine and after treatment system control algorithms and engine performance specifications.
- 4.6.5. Following generic rules may be utilized as example for extensions of type approval certificate:
 - 4.6.5.1. **No emission test requirements necessary:**
 - (a) change to part numbers declared through type approval documentation that is not emission affecting;
 - (b) part number change of emission affecting component that is just an administrative change supported with due declarations (proto to production Part number change as an example);
 - (c) change(s) to emission strategy for engine operation beyond altitude and temperature conditions prescribed by this Regulation however with due declaration with technical agency in this regard;
 - 4.6.5.2. **Emission test compliance required:**
 - (a) performance or specification or source change of a component declared through type approval documentation that is emissions affecting. This applies to any such component in engine and after treatment system including software;
 - (b) emissions strategy changes such as but not limited to fuelling timing, fuelling qty, fuelling modes,
 - (c) addition of alternate source component that is emission affecting with or without part number change;
 - 4.6.5.3. Emission and NOx Control Diagnostics compliance required:
 - (a) in addition to clause 4.6.5.2 at discretion of technical agency if changes to NOx control diagnostics limits or strategy or software is carried out;
 - (b) NOx control diagnostics demonstration method through failed part has been changed;
 - 4.6.5.4. In the event of an extension the Test Agency shall establish an updated communication denoted by an extension number that shall be incremental in accordance with the number of successive extensions previously granted. That communication shall clearly show the reason for the extension and the date of extension.

4.7 Type Approval Process Flow-chart

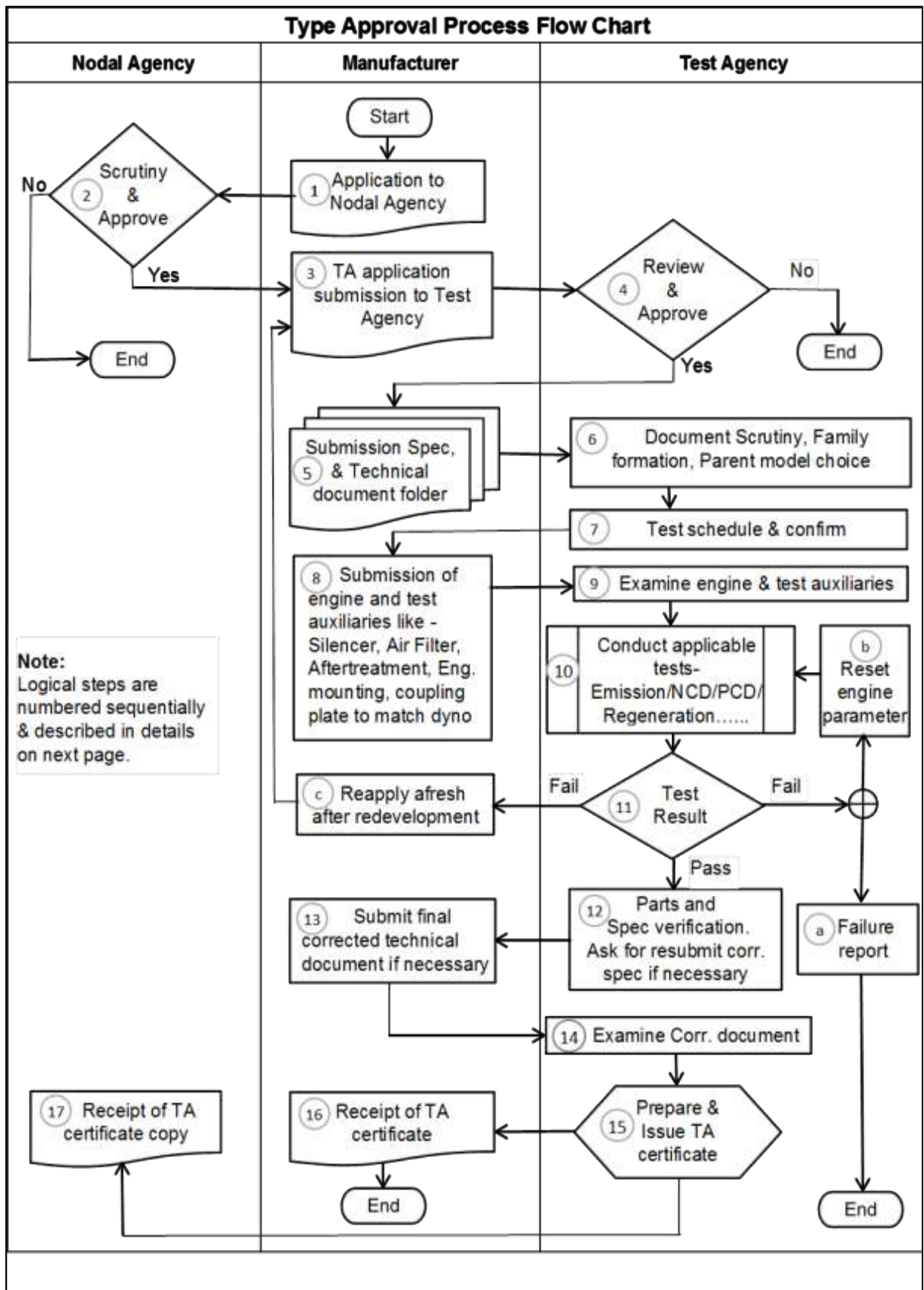

4.8 Following are the logical steps for the type approval process flow chart described in brief stepwise -

1. Application to nodal agency (CPCB) in the form of affidavit seeking permission for type approval of Genset engine family through submission provided as draft specimen in Appendix 1.
2. Upon written approval of nodal agency to manufacturer and chosen technical agency; (*This could be decision making node with "Yes" / "No" loop*)
3. Submit type approval certification application to chosen test agency. Based on provisions such application can be written or online through their secured portal;
4. Obtain technical agency approval (*This could be decision making node with "Yes" / "No" loop with NO means, provide additional data*)
5. Upon agencies application scrutiny and negotiations, submit detailed technical documentation as per requirements described in Annexure 1;
6. Obtain documentation approval from technical agency, family formation, choice of parent engine, provide additional data
7. Obtain test plan / schedule from technical agency
8. Upon approval from technical agency plan for providing engine test auxiliaries like -Silencer, air filter, after-treatment systems, engine mounting, coupling plate to match dyno, components for NCD demonstration etc.
9. Upon receipt of engine along with auxiliary technical agency examine the adaptability in test cell, make necessary modification in exhaust line, mounts, etc, if required.

Certificates of the NG/LPG fuel system components as per Annexure 10 to be validated from test agency. In absence of valid component certificate, the component to be tested and approved from test agency as per applicable standard

Alternate Fuel Gensets to be Type Approved as per safety code of practice as mentioned in document A4 before applying for noise certification. Competent authority will perform safety audit at Genset manufacturer location based on the part A4 document.

10. Conduct applicable tests-
 - 10.4. Conduct emissions test to qualify (*This could be decision making node with "Pass" / "Fail" loop. "Fail" means, a) current TA application is closed out with failure report b) adjust. reset engine parameter for retest or c) further manufacturer may re-apply afresh after redevelopment*)
 - 10.5. Conduct NCD demonstration tests to comply (*This could be decision making node with "Pass" / "Fail" loop. "Fail" means, a) current TA application is closed out with failure report b) adjust. reset engine parameter for retest or c) further manufacturer may re-apply afresh after redevelopment*)
 - 10.6. Demonstrate results related to infrequent regeneration, control condition if applicable;
11. Review of all test results with manufactures and decision about compliance, in case of failure manufacture have three options to proceed a, b, & c, act accordingly.
12. Technical agency carries out part verification of critical engine components and injection timing verification in compliance with document submission, take final review of technical document and ask manufacture to resubmit if necessary
13. Manufacture submit the corrected technical document if found necessary
14. Examine corrected document submitted in line with the requirement
15. Technical agency prepares technical report based on tests;
16. Technical agency issues type approval certificate to manufacturer;
17. Technical agency forwards a copy of type approval certificate to nodal agency

End

Appendix – 1

Application to Nodal Agency. Specimen for Submission of Affidavit & Profile details of manufacturer

Part - A

NOTARISED AFFIDAVIT ON NON-JUDICIAL STAMP PAPER -

[To be submitted to the Nodal Agency by a supplier approaching for the first time for TA]

I,, Chairman / President / Managing Director / Partner / CEO / COO / Proprietor of M/s, having Registered Office at engaged in manufacturing / import of Genset diesel/dedicated alternate fuel/Bi-fuel /dedicated gasoline / Portable Generator sets with manufacturing facilities / ware house at:

- i)
- ii)

am authorized to swear this affidavit for and on behalf of the above named Company. I do hereby solemnly affirm and declare as under:

1. That the deponent is well conversant with the facts and competent to swear this affidavit.
2. That the deponent declares that M/s are manufacturer / importer of Genset diesel / dedicated alternate fuel/Bi-fuel /dedicated gasoline / Portable engines in the brand name
 - i)
 - ii)

(Strike out if not applicable)

3. That the deponent declares that M/s are importer of diesel /dedicated alternate fuel/Bi-fuel /dedicated gasoline / Portable generator sets from M/s i)
(ii) M/s (Complete address)
(Strike out if not applicable)
4. That the deponent declares that M/s will obtain Type Approval / Conformity of Production verification only from (Name of the Certification Agency) and will not approach any other Certification Agency for Type Approval / Conformity of Production verification for any of their Genset diesel / dedicated alternate fuel/Bi-fuel /dedicated gasoline / Portable engines models, without prior permission from the nodal agency.
5. That the deponent declares that none of the Chairman, Managing Director, Partner, Director, Proprietor, Board Member in M/s has been involved with a Company / Firm which has manufactured and sold non-compliant Genset diesel/ dedicated alternate fuel/Bi-fuel /dedicated gasoline / Portable engines.
6. That the deponent declares that M/s will manufacture / import and sell only compliant Genset diesel/ dedicated alternate fuel/Bi-fuel /dedicated gasoline / Portable engines

(Name & signature with Co. stamp)

(DEPONENT)

VERIFICATION

Verified at on thisof20..... that the contents of the above affidavit are true and correct to the best of my knowledge and belief and nothing has been concealed therein.

Place:

Date.....

(Name & Signature with Co. Seal)

(DEPONENT)

Part - B

Format for Submission of Profile and Details of the Supplier

A. Company details

- Name of the Company
- Type of Company: Proprietor / Partnership / Private Ltd / Public Ltd
- Name of the Proprietor / Partners / Directors (submit relevant documents)
- Importer / manufacturer
- Registered Office Address with phone number
- Contact Address with phone number, fax number, email etc.
- Name and designation of the authorized person for submission of documents and to deal with the certification agency
- Plant addresses and contact details, in case of manufacturer
- Ware house address, in case of importer (This cannot be changed without prior intimation to Nodal Agency and Certification Agency)
- Name of the company from whom to import and its contact details, in case of importer
- Plant details, from where to import
- Authenticated Copies of following documents to be submitted
 - v) Manufacturing License from Directorate of Industries / Department of Industry (in case of Manufacturer), IEC Code (in case of importer)
 - vi) VAT and CST/GST Registration
 - vii) Excise Registration, in case of manufacturer
 - viii) Consent from State Pollution Control Board/ Pollution Committee
- No. of employees
- Engineers (if any)
- Last year Turn-over
- Any other business

B. Details of Genset engine (Proposed) manufactured / assembled / imported

Sr No	Model Names	Nos. produced /imported in current year	Nos. expected to be produced / imported in the next year
a			
b			

c			
d			

C. Details of Infrastructure

D. Land: Owned / Rented

Area (m²):

E. Covered Area

F. Machinery for manufacture

a)

b)

c)

d)

G. Testing facility equipment's

a) Load bank type and capacity

b) Measuring Instruments

c) Any other

H. Quality Control

1. Quality Control In charge

2. Quality Procedure:

ISO Certified since when (Enclose a Copy of Operating Procedure)

3. Pre-delivery Inspection Procedure on Gensets (including records maintained)

4. System of serial numbering and marking on Genset and their sub-systems – e.g. all Enclosures, etc.)

5. Any other

Date:

Place:

SIGNATURE OF THE
(Chairman /President / Managing Director
/ Partner / CEO / COO / Proprietor)

SEAL OF THE COMPANY

---End---

5. Conformity of Production Administrative Procedure

5.1 General

- 5.1.1. Conformity of Production (COP) compliance is designed to ensure manufacture's compliance and control towards a type approved genset engine family to statistically ensure engines sold under such emission certification does meet required emissions and other requirements including NOx diagnostics provisioned by this Regulation;
- 5.1.2. COP process compliance also ensures type approval certificate validity and hence right to produce and sale genset engines by a manufacturer owing such type approval certification for the next COP-year. Such provision is administratively provided by issuing Conformity of Production Certificate;
- 5.1.3. Each manufacture shall subject it's engine model range to the verification of COP, every year. For this, the year shall mean the period from 1st July of the calendar year to 30th June of the succeeding calendar year; - For above 19kW power rating
- 5.1.4. Each manufacturer shall subject engine model(s) for NOx Control Diagnostics (NCD) compliance test representative of it's NCD family as declared during type approval certification for it's entire genset engine model range. Depending on engine types certified, a manufacturer may need to submit apt and separate representation of engine types representing NCD families. Such demonstration and compliance shall be required once per COP-year per NCD family.
- 5.1.5. For this, the year shall mean the period from 1st July of the calendar year to 30th June of the succeeding calendar year;

5.2. Verification of Conformity of Production (COP)

5.2.1. COP of domestically manufactured engine families' up to 19 kW:

- 5.2.1.1. In case engines up to 19 kW power rating, the verification of COP shall be done once in a COP-year as per plan described in following 'Table 1'

Table 1

Number of families to be tested for verification of COP for domestic manufactures (for engines up to 19 kW)

Total number of families of the domestic manufacturer	Total number of families to be tested per year
1 – 3	1
4 – 7	2
8 – 11	3
12 – 15	4
>15	5

5.2.2. COP of domestically manufactured engine families more than 19 kW rated output and imported engines of all rating:

Domestically manufactured engines of more than 19 kW rated output and imported engines of all ratings shall be subjected to the verification of COP once for every 1000 units per family or once a year, whichever is earlier;

- 5.2.3. Domestically manufactured engine models(s) and imported engines of all ratings shall be subjected to the verification of NCD once every COP-year by NCD family(ies) representative

engine(s). Such demonstration is NCD family dependant and irrespective of combined volumes produced and sold under such family(ies).

5.3. Sample size, Decision and Other Criteria for verification of COP

- 5.3.1. In case of engines defined in clauses 5.2.1.and 5.2.2. above, testing shall be done on sample(s) randomly selected by certification agency from the production line / import warehouse, of one model for each family selected for COP.
- 5.3.2. In case of engines defined in clauses 5.2.3. above, testing shall be done on sample(s) randomly selected by certification agency from the production line / import warehouse for NCD compliance;
- 5.3.3. In case engines up to 19 kW power rating, a minimum quantity of 10 numbers or one day's average production volume of the engine model selected by technical agency, whichever is more shall be made available for random selection. Same criteria shall apply to random selection of after treatment system that is not integrated with engine system;
- 5.3.4. In case of domestically manufactured engines more than 19 kW power rating, a minimum one day's average production volume of the engine model selected by technical agency, shall be made available for random selection subject to minimum quantity of 3. This limit shall not be applicable in case of import of all ratings. Same criteria shall apply to random selection of after treatment system that is not integrated with engine system;
- 5.3.5. If the manufacturer is not of Indian origin, the manufacturer should establish a base office in India, which is to be declared in the initial application submitted to Nodal Agency as per Appendix 1 This base office will be responsible for Type Approval and COP compliance;
- 5.3.6. The manufacturer shall request the certification agency when they would like to make random selection of engine(s) and to seek their schedule / availability for completing the COP test;
- 5.3.7. COP verification shall be carried out for each plant of the domestic manufacturer. For imported engines, the COP testing shall be carried out on the engine manufactured for each country of origin irrespective of engine family being same;
- 5.3.8. The certification agency shall intimate to the manufacturer the schedule (month) of sampling / testing. The manufacturer shall inform the production/ import plan for the month in which the technical agency wants to carry out the COP, to the technical agency. If the manufacturer has a problem due to particular reasons such as the particular model is not likely to be scheduled for production / import at that time, or enough number of engines may not be available for random selection; the time schedule may be modified based on mutual convenience of the manufacturer and the technical agency;
- 5.3.9. The manufacturer shall complete all COP activities (such as random selection, initial running-in, emission testing, NOx Diagnostics testing and documentation) at least one month before the end of COP-year. The COP certificate shall not be issued in case of non-adherence to above schedule unless such schedule attainment is due to unavoidable reasons such as but not limited to test facility downtime, extended COP process encountered.
- 5.3.10. Following 'Table 2' gives the deadlines for the respective COP-year for the COP activities. However, manufacturer can take early action on each activity to ensure compliance.
- 5.3.11. Manufacturer must take early action on each activity for the families (more than 19 kW rated output) exceeding 1000 units of production to ensure the compliance of clause 5.2.2.

Table 2

Sr No	Activity Description	Last Date
1	Submission of production / import plan / actual details to test agency	1st March
2	Random Selection	1st April
3	Submission of engines and subsequent testing (Including extended COP if any)	31st May
4	Completion of documentation and COP Certificate issuance	30th June

- 5.3.12. The manufacturer shall inform the test agency regarding the stoppage of production of a specific model, in case this has not been anticipated at the start of the COP period. This shall be intimated well in advance so that COP selection of the engine can be completed by the technical agency before stoppage of production. Manufacture is held accountable for ensuring COP is conducted and samples are made available per requirements of this Regulation;
- 5.3.13. The manufacturer shall provide all the assistance required by the technical agency for completing the tests;
- 5.3.14. The latest updated technical specifications, procedure of pre-delivery inspection (PDI), running-in and servicing of the engine, shall also be submitted before the engine selection, if there have been revisions after the previous COP / type approval;
- 5.3.15. Pre-delivery inspection as per owner's instruction manual / service manual will be carried out by the manufacture as per procedure declared at the time of type approval and as amended and intimated to concern technical agency from time to time for the selected engine(s), under the control of technical agency;
- 5.3.16. The running-in of the engine(s) shall be carried out as per the manufacture's recommendation submitted during the type approval and as amended and intimated to the concern technical agency from time to time, for engine(s) under control of the technical agency. Running-in may also be carried out at engine manufacture's place under the control of technical agency provided adequate facilities are available. After such running-in procedure, manufacture will be permitted to carry out all the adjustments recommended in their owner's / service manual and as amended and intimated the concern technical agency from time to time published with technical agency, under the control of the technical agency;
- 5.3.17. In case of failure of any major component during the running-in or testing, the technical agency may permit to replace component only once; which has failed and which does not affect the performance and emission of the engine. Such decision is entirely with technical agency. In case of failure of emission affecting component, random selection of engine at manufacture's plant or warehouse shall be done afresh. If for such randomly selected engine (second time) or a replaced component fails again, it shall be reported to the nodal agency by the concern technical agency and agency shall await instructions from the nodal agency for further action;
- 5.3.18. The manufacture shall submit the randomly selected engine(s) to technical agency within four weeks (8 weeks in case of import subjected to last date as mentioned in clause 5.2.10. – Table 2) of completion of running-in for emission compliance test and NOx diagnostics test where applicable. Manufacturer also shall supply appropriate 'failed' parts for NCD and/or PCD demonstration in line with agreement with technical agency during type approval certification and documentation;
- 5.3.19. The technical agency should endeavour to complete the required testing of selected engine(s) within four weeks after submission of engine(s);
- 5.3.20. The testing shall be done as per applicable procedures and specifications described in Annexure 7 with test facility compliant to requirements specified Annexure 4 while utilizing data evaluation and result calculation procedures described in Annexure 5 of this Regulation;

5.3.21. Sampling plan for COP

5.3.22. Sampling Plan-I is applicable to domestically manufactured engine upto 19 kW rated output whereas Sampling Plan-II is applicable to domestically manufactured engine above 19kW as well as for imported engines of all ratings (Imported as an engine or as a genset)

5.3.23. Sampling Plan-I: Upto 19kW domestic

5.3.23.1. The number of samples to be tested shall be minimum as necessary, as given in Table 3 to arrive at a decision on whether the production unit complies with applicable emission limits;

5.3.23.2. A sample said to have failed for particular criteria pollutant if the test result of the sample for the criteria pollutant exceeds required DF and IRAF (if applicable) corrected emission limit;

5.3.23.3. The production units of all models in the family shall be deemed to comply with the emission limits if the number of failed samples as defined in clause 5.3.23.2. above for each criteria pollutant is less than or equal to the pass decision number appropriate to the cumulative number of samples tested for that criteria pollutant as given in Table 3;

5.3.23.4. The production units of all models in the family shall be deemed to be non-complying with the emission limits if the number of failed samples as defined in clause 5.3.23.2. above for each criteria pollutant is more than or equal to the fail decision number appropriate to the cumulative number of samples tested as given in Table 3;

Table 3

Sampling plan I and decision criteria for the verification of COP of the engines

Cumulative Samples	Pass decision	Fail decision	Cumulative Samples	Pass decision	Fail decision
	No. of failure			No. of failure	
1	(a)	(b)	16	6	11
2	(a)	(b)	17	7	12
3	(a)	(b)	18	7	12
4	0	(b)	19	8	13
5	0	(b)	20	8	13
6	1	6	21	9	14
7	1	7	22	10	14
8	2	7	23	10	15
9	2	8	24	11	15
10	3	8	25	11	16
11	3	8	26	12	16
12	4	9	27	12	17
13	5	10	28	13	17
14	5	10	29	14	17
15	6	11	30	16	17

(a) : Series not able to pass at this stage

(b) : Series not able to fail at this stage

Note:

- v) COP compliance or non-compliance decision is on the basis of number of failures within the respective cumulative samples tested.
- vi) During successive testing, the decision which reached first is the final.
- vii) Minimum 4 samples are required to test to reach pass decision
- viii) Minimum 6 samples are required to test to reach fail decision

5.3.23.5. Once a compliance or non-compliance decision is made for a particular criteria pollutant, the result of testing of subsequent samples for that criteria pollutant shall not influence the decision;

5.3.24. Sampling Plan-II: Above 19kW & Imported all rating

- 5.3.24.1. One engine sample selected randomly shall be tested as per procedure described in Annexure 7 of this Regulation;
- 5.3.24.2. If the engine sample as tested fails to comply with the emission limits, the manufacturer may ask for measures to be performed on a sample of engines taken from the production series and including the engine originally tested. The manufacturer shall specify the size 'n' of the sample subject to 'n' being minimum of 3 and maximum of 10 inclusive of sample originally tested;
- 5.3.24.3. The production or import units of all models in the family shall be deemed to comply with emission limits if following condition is met for each criteria pollutant except for Smoke limits:

$$\bar{x} + k \cdot S < L$$

Where,

\bar{x} = arithmetic mean of the results of the tests conducted on 'n' number of samples, for a particular specie

S = Standard deviation of the results of the tests conducted on 'n' number of samples, for the specie = $[\sum (x - \bar{x})^2 / (n - 1)]^{1/2}$

x = results of the tests conducted on 'n' number of samples, for the specie.

L = the emission limit for the specie

k = a statistical factor dependent on 'n' number of samples and as given in below table.

Table 4

Values of Statistical Factor 'k' with respect to parameter 'n'

n	2	3	4	5	6	7	8	9	10
k	0.973	0.613	0.489	0.421	0.376	0.342	0.317	0.296	0.279

5.3.25. Miscellaneous failure during COP

5.3.25.1. Reserved

5.3.25.2. **Gross Power failure** : For verifying the conformity of production, if the selected engine does not meet the gross power and rated speed limit as applicable, the another two engines in case above 19 kW power rating or four engines in case below 19 kW power rating, will be taken from the series at random and be tested as per this part. All these selected engines shall meet the limit values specified. One engine shall be subjected to the emission test for the conformance of production.

5.3.25.3. Reserved

5.3.25.4. **NCD / demonstration failure** : For verifying the conformity of production, if the selected engine does not meet the compliance requirement with respect to NCD demonstration as applicable, the another two engines in case above 19KW power rating or four engines in case below 19KW power rating, will be taken from the series at random and be tested as per this part. This selected all engines should meet the limit values specified. One engine shall be subjected to the conformance of production.

5.3.25.5. If further same failure noted in any of the additionally selected samples of caluse 5.3.25.1, 5.3.25.2, 5.3.25.3 & 5.3.25.4, the production shall be considered as non-compliance and the provision of clause 5.8, shall be put into effect.

5.4. Certificate of Conformity of Production (COP) and Its Validity

- 5.4.1. After verification for COP, the certification agency shall issue a COP verification report to the manufacturer within one month of the date of testing completion, indicating compliance or non-compliance. In case of compliance, the technical agency shall issue a COP certificate to the manufacturer as per format prescribed in Annexure 2 along with report. At the end of CoP year, details of CoP & the copies of certificate as well as report shall also be forwarded to the Nodal Agency;
- 5.4.2. Certificate of conformity of production is required to commence the production and sale of domestic genset engines in immediately next COP-year. Validity of current COP certificate shall be till successful compliance of first COP test in next COP-year
- 5.4.3. In given COP-year for engine type(s) described in clause 5.2.2., successful compliance of COP for every 1000 engines invoiced by the manufacturer shall enable further production of 1000 engine(s) and thereafter, in case engine(s) volumes for a particular engine family exceed 1000 units annually;
- 5.4.4. The COP certificate will be issued at the end once all the numbers of engine samples demanded as per the production plan submitted become tested successfully. Intermediate COP certificate i.e at each sample tested shall not be issued, However the test data report will be issued at every test sample.

5.5. COP Discontinuity

- 5.5.1. If there is no production or import of model(s) of a particular engine family for two consecutive years immediately after obtaining type approval or immediately after obtaining COP certificate, the type approval certificate for that particular engine family becomes invalid. In case the manufacturer wants to manufacture or import engine model(s) of such particular engine family, then the manufacturer shall approach Nodal Agency and technical agency to obtain a new Type Approval certificate afresh following stated procedure;
- 5.5.2. If there is no production or import of model(s) of a particular engine family for two consecutive years immediately after obtaining type approval and if the COP test is requested for the third year, then the supplier shall approach Nodal Agency to obtain approval for the extension of validity of Type Approval. This is applicable only for a new manufacturer and in case no engine(s) sale has happened post type approval;

5.6. Exemption from COP

In the following cases, engine family(ies) shall be exempted from COP process.

- 5.6.1. If Type Approval obtained in the last quarter of COP year. This clause is not applicable to the manufacturer as mentioned in clause 4.4.5.
- 5.6.2. In case of no production or import, the manufacturer shall submit a declaration to technical agency and Nodal Agency for 'No production or import' of a particular family models for every COP-year;
- 5.6.3. The COP test shall be conducted by technical agency for the next COP-year, upon receipt of declaration by the manufacturer that there was no production or import during current COP-year;
- 5.6.4. Declaration in this regard should be submitted before end of third quarter of the current COP-year; (i.e 31st March), if produced after 31st March, COP is applicable.
- 5.6.5. Any genset engine manufactured for purpose of export outside India. COP exemption shall apply for such volumes and COP test exemption shall apply if all such engine(s) produced are exported;
- 5.6.6. Any domestically manufactured genset engine intended for the purpose of sample (Maximum number of 4 units per engine family) only and not for sale in India;
- 5.6.7. Any genset engine imported for the purpose of sample testing, bench making and not intended for any commercial sale (Maximum number of 4 units per year);

- 5.6.8. Any genset engine imported for the round robin or laboratory correlation tests. Such engines shall be exported back within 12 months from the date of import; or it should be scrapped and a scrap certificate shall be provided.
- 5.6.9. For obtaining exemptions regarding clauses 5.6.6, 5.6.7 and 5.6.8, the manufacturer shall obtain written approval from Nodal Agency.
- 5.8.10. For obtaining exemptions regarding 'No production or import' as per clauses 5.6.2, the manufacturer shall obtain written approval from Nodal Agency. Nodal agency should endeavor to respond within 4 week after the receipt of application.
- 5.6.10. COP exemption shall be maximum up to three consecutive COP year, to resume sell from fourth year a fresh type approval shall be conducted
- 5.6.11. After obtaining exemption as per 5.6.2, once production resume, manufacturer shall first conduct COP before making any sell.

5.7. Production Definitely Discontinued

- 5.7.1. If manufacturer decides to discontinue production / withdraw type approval certificate of a specific engine family or multiple families from a specific plant or all plants, the manufacturer shall so inform to Test Agency involved in type approvals and COP compliance at least three month before the stoppage of production;
- 5.7.2. In such case, the manufacturer shall ensure COP compliance for the engine family(ies) from every manufacturing plant before the production of the engine family(ies) is discontinued following COP compliance process described in clauses 5.1, 5.2, 5.3 and 5.4 of this Regulation;
- 5.7.3. Upon receiving the relevant communication, the Test Agency shall inform the manufacturer the acceptance of the communication and provide an acceptance letter.

5.8. Consequences of non compliance

- 5.8.1. If the COP verification report of the technical agency for a model family indicates non-compliance, the manufacturer must stop manufacturing with immediate effect;
- 5.8.2. Further, the manufacturer must analyze the reasons for non-compliance, plan to take corrective actions in design, production line and units already produced and submit a report to the nodal agency with a copy to concern technical agency within four weeks of the receipt of the COP verification report;
- 5.8.3. If the manufacturer is unable to diagnose the reasons for non-compliance within stipulated time, this shall be clearly stated in the report;
- 5.8.4. Based on the diagnostics and corrective action plan submitted by the manufacturer, the Nodal Agency in consultation with technical agency and if both decide to, in consultation with standing committee, may take any of the following actions:
 - 5.8.4.1. Allow continuation of production or import of all models in the family if it is satisfied with the corrective actions planned or taken by the manufacturer and ability to meet emission norms;
 - 5.8.4.2. Allow continuation of production or import of some or all other models of the engine family if it determines that the reasons for non-conformance of the tested model are not relevant to these models; with or without additional verification of COP in due course;
 - 5.8.4.3. Stop production or import of some or all other models of the engine family till compliance is demonstrated by the supplier, through a re-verification of COP. In case of imported model(s), the non-compliant genset should be sent back to the original destination;
- 5.8.5. The manufacturer shall be given an opportunity to explain its views before taking final decision;
- 5.8.6. It is responsibility of the manufacturer to ensure at his cost that the modifications are carried out such as field retro fitment campaigns within period specified by the Nodal Agency on all products produced as well as sold / dispatched in the period between the dates from which the COP

became due and re-verification of COP or as decided by the Nodal Agency, in consultation with standing committee;

- 5.8.7. Nodal Agency with help from Technical agency shall audits compliance in field on random basis for corrections done and issues closure letter to manufacturer
- 5.8.8. Further, to avoid such non-compliances again in future, following precautionary measures shall be initiated to strengthen the process which will be followed for next two COP cycle after re-certification & resuming the production with new modified spec;
 - a) COP compliance shall be established once for every 500 units of production
 - b) First COP compliance to be established before crossing 50 units of production once production resume with modified spec.
 - c) COP activities to be completed in all by 31st March every COP year for the next three years. After 3-year, COP shall be as per normal practice/timeline.

5.9 COP Process Flow Chart

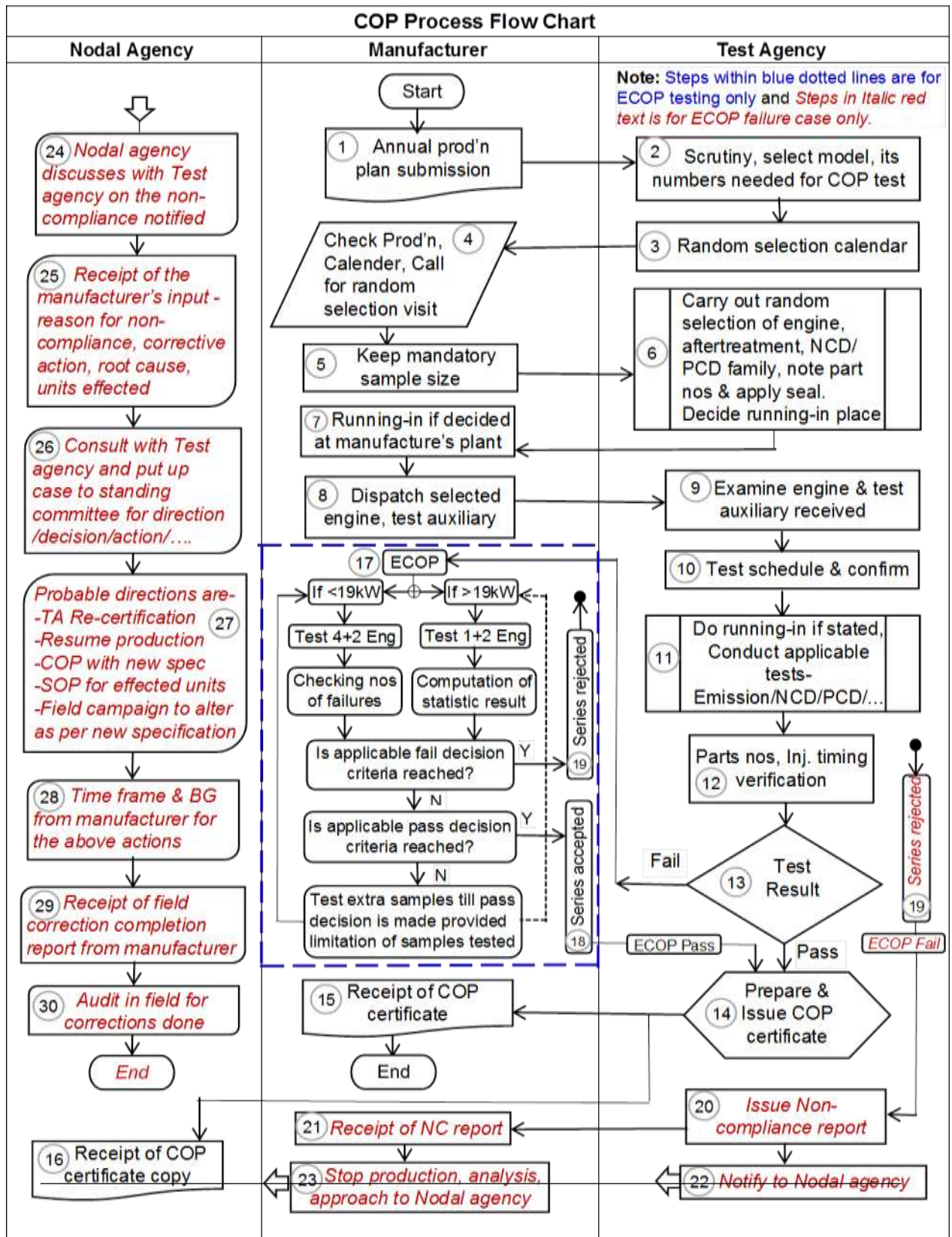

Following are the logical steps for the COP process flow chart described in brief stepwise-

COP cycle shall end with either -

- I. COP compliance with regular sample testing (Steps 1-16)
- II. COP compliance with extended samples testing (.... Steps 17-18)
- III. COP non-compliance after extended testing (.... Steps 19-30)

CASE I:

1. Manufacturer with valid Type Approval and COP certification submits annual estimated production/ import volume data to technical agency involved in the format provided within two months of start of new COP-year.
2. Technical agency, based on the production/import volumes, communicates to manufacturer, the engine type chosen and the number of samples needed for COP compliance test for all engine families of that manufacturer within one month of submission of above production volume data;
3. Technical agency also communicates to the manufacturer plan for COP engine random selection based on manufacture's input above;
4. Manufacturer coordinates adhering to technical agency provided or negotiated plan and coordinates for engine random selection at manufacturing plants/warehouses/sales points for imported engines as the case may be.
5. At the point of selection as mentioned in Sr 4, manufacturer provides with minimum required sample size for random selection;
6. Technical agency representative carries out random selection and does note emission critical component part and serial numbers. Provides with appropriate seal for avoiding tampering of assembly parameters further;
Technical agency representative randomly selects after treatment system if applicable;
Technical agency representative can also carry out random selection of an engine if from chosen representative engine family for NCD compliance utilizing the same pool of engines offered;
7. Decision, if running-in is carried out at manufacturer's location or technical agency location;
If running-in is agreed to be carried out at manufacture's facility, running-in shall be started in presence of technical agency representative.
8. Engine along with arranged after treatment shall be transported to technical agency test location;
9. Upon receipt of engine along with auxiliaries, technical agency examines the adaptability in test cell, make necessary modification in exhaust line, mounts, etc, if required.
10. Technical agency communicates the test schedule to manufacture for his witness
11. Technical agency carries out engine qualification and emissions test per applicable procedure and shares results with manufacturer;
12. Technical agency carries out critical component type/part numbers, injection timing verification and match with type approved document, in case any change noted, manufacturer to provide the declaration in this regard, till time COP certificate will be on hold.
13. Review of test result & decision on compliance;
14. If COP compliance is obtained, Technical agency prepared the compliance certificate within 4 weeks from the date of testing. Engine & after treatment, test auxiliary is returned to the manufacturer;
15. Technical agency issue compliance certificate to manufacturer
16. Technical agency forwards a copy of compliance certificate to Nodal agency

CASE II:

17. **ECOP:** If non-compliance observed after testing (at Stage No 13), process begins from extended random selection of engine(s) as per preferred options prescribed in clause 5.3.20.
- **ECOP > 19KW (Statistics is on the basis of failed emission values)**
 - 17.1 Initially test 2 more new engines
 - 17.2 Computation of the test statistic result of 3 engines (1-originally tested + 2 new)
 - a) According to the appropriate clause does the test statistic result agree with the criteria for failing the series
 - b) According to the appropriate clause does the test statistic result agree with the criteria for passing the series
 - 17.3 If, answers of a & b are NO, then; continue the testing on additional samples till pass decision is made provided limitation of samples tested as applicable (10 numbers maximum)
 - **ECOP < 19KW (Statistics is on the basis of numbers of failed engine)**
 - 17.4 For establishing the compliance minimum 4 samples are mandatory to be tested and all 4 samples should pass.
 - 17.5 If some samples failed, the additional new more samples, are required to be tested, the numbers depend on the number of samples failed earlier,
 - 17.6 Initially test 2 more new engines
 - 17.7 In the cumulative samples (4-originally tested + 2 new), note the numbers of failed samples
 - c) According to the appropriate clause does the number of failed samples agree with the criteria for failing the series
 - d) According to the appropriate clause does the number of failed samples agree with the criteria for passing the series
 - 17.8 If, answers of a & b are NO, then; continue the testing on additional samples till pass decision is made provided limitation of samples tested as applicable (30 numbers)
18. If during testing if the pass decision criteria is reached, the series is deemed to be compliance and COP certificate is issued (then continue from Stage14-16)

CASE III:

19. If during testing if the fail decision criteria is reached, the series is deemed to be non-compliance;
Or if Manufacturer opts to declare non-compliance without availing total number of samples allowed to be tested, the series is deemed to be non-compliance
20. Technical agency prepares the COP failure report
21. Technical agency issue COP failure report to manufacturer
22. Technical agency informs nodal agency about COP non-compliance of said engine family
23. Manufacturer stops production or import of the said non-compliant engine family;
Manufacturer informs nodal agency about non-conformity, stoppage of production and dispatch and their plan for failure investigation within 4 weeks of receipt of COP verification report or COP failure intimation
24. Nodal agency discusses with test agency in details on the non-compliance notified.
25. Nodal agency replies to the manufacturer about their inputs on timelines by which compliance shall be obtained as well as failure root cause and corrective action plan submission. Nodal agency also informs about any financial penalty or assurance required from the manufacturer;
Manufacturer submits root cause analysis and corrective action plans to nodal agency in consultation with technical agency;

26. Nodal agency in consultation with technical agency reviews manufacture's submissions and decides if such case shall be put forth for standing committee review and guidance if found necessary depending upon the severity of the failure.

If decided to represent at standing committee, nodal agency brings this issue to standing committee and allows manufacture to represent their submissions. If standing committee agrees / approves manufacturer's submission and plan then;

27. Nodal Agency can also decide on their own & shall take following decision:

27.1 Gives written permission to technical agency to proceed with re-verification of COP with improvements implemented by manufacturer and also type approval re-certification as the case may be.

27.2 Manufacturer offers engine sample and technical documentation to technical agency and complies with COP;

27.3 Technical agency issues compliance certificate or type approval certificate if newly approved as an option;

27.4 Manufacture begins production after obtaining new Type Approval or COP compliance certificate;

27.5 Manufacturer completes corrective actions on engines dispatched during period of COP and COP failure date;

28. Manufacturer complies with 'financial assurance related' documents asked by Nodal Agency;

29. Manufacturer submits corrective action / campaign report with adequate evidences to Nodal Agency

30. Nodal Agency with help from Technical agency audits compliance in field for corrections done and issues closure letter to manufacturer;

End

ANNEXURE – 1
Information Document from Manufacturer
Appendix – A.1
Templates for information folder and information document

1. Information folder

The information folder referred to in clause 4 of this Regulation shall contain the following:

1.1 A list of contents;

- 1.1.1 Approval copy from Nodal Agency with regard to Appendix 1
- 1.2 Manufacturer's declaration on adherence to all requirements of this Regulation in accordance with the template set out in this Appendix
- 1.3 Manufacturer's statement on the compliance of the engine type or engine family with the exhaust emission limits set out in clause 3.1 of this Regulation with regard to specified liquid fuels, fuel mixtures or fuel emulsions other than those set out in Appendix 11 of Annexure 7
- 1.4 For electronically controlled engines of categories Genset , complying with the emission limits set out in Clause 3.1 to this Regulation and using electronic control to determine both the quantity and timing of injecting fuel or using electronic control to activate, de-activate or modulate the emission control system used to reduce NO_x, a complete overview of the emission control strategy, including the base emission control strategy and the means by which every auxiliary control strategy directly or indirectly controls the output variables;
 - 1.4.1 Additional confidential information as set out in Appendix A.2 shall be made available, only for the technical service performing the tests and not included in the information folder;
- 1.5 Where applicable, a full description of the functional operational characteristics of the NO_x control measures and inducement system as referred to in Annex 9 to this Regulation;
 - 1.5.1 Where applicable, a copy of the demonstration reports set out in paragraphs A.1.10.5. and A.1.13.4. of Appendix A.1 of Annexure 8;
 - 1.5.2 Where applicable, a description of the connection for, and method to read, the records set out at paragraph A.1.5.2.1.1. (e) of Appendix A.1 of Annexure 8;
 - 1.5.3 Where the engine type or engine family is member of a NCD engine family, a justification of its membership together with the information requested in paragraph 1.5., 1.5.1. and 1.5.2. on the NCD engine family may be supplied alternatively, upon agreement of the Type Approval Authority;
- 1.6 Reserved
 - 1.6.1 Reserved
 - 1.6.2 Reserved
- 1.7 Reserved Manufacturer's declaration, and supporting test reports or data, on deterioration factors as referred to in clause 3.2.5 of Appendix 6 of Annexure 7 of this Regulation;
 - 1.7.1 Where the engine type or engine family is a member of an engine after-treatment system family, a justification of its membership together with the information requested in paragraph 1.7 on the after-treatment system family may be supplied alternatively, upon agreement of the Type Approval Authority;
- 1.8 Where applicable, the manufacturer's declaration, and supporting test reports or data, of the infrequent regeneration adjustment factors referred to in Annex 4 to this Regulation;
 - 1.8.1 Where the engine type or engine family is a member of an engine-after-treatment system family, a justification of its membership together with the information requested in paragraph 1.8 on the

engine-after-treatment system family may be supplied alternatively, upon agreement of the Type Approval Authority;

- 1.9 Manufacturer's declaration and supporting data demonstrating that the emission control strategies fitted are designed in such a way as to prevent tampering to the extent possible, as referred to in Appendix 3 of Annexure 8 of this Regulation.
- 1.9.1 For engine types and engine families that use an Electronic Control Unit (ECU) as part of the emission control system the information shall include a description of the provisions taken to prevent tampering with and modification of the ECU including the facility for updating using a manufacturer approved programme or calibration;
- 1.9.2 For engine types and engine families that use mechanical devices as part of the emission control system the information shall include a description of the provisions taken to prevent tampering with and modification of the adjustable parameters of the emission control system. This shall include the tamper resistant components such as carburettor limiter caps or sealing of carburettor screws or special screws not adjustable by user;
- 1.9.3 In order to place engines from different engine families into the same tamper prevention engine family the manufacturer shall provide confirmation to the Type Approval Authority that the measures used to prevent tampering are similar.
- 1.10 A description of overall quality-assurance management systems for conformity of production in accordance to clause 5 of this Regulation;
- 1.11 A list of scheduled emission-related maintenance requirements and the period at which each should occur including any scheduled exchange of critical emission-related components;
- 1.12 The completed information document as set out in clause 2 of this Annex;
- 1.12.1 Where the particulars appearing in the information document for an engine approval have changed, the manufacturer shall submit revised pages to the approval authority showing clearly the nature of the change(s) and the date of re-issue;
- 1.13. All relevant data, drawings, photographs and other information as required in the information document;

2. Information document

The information document shall have a reference number issued by the applicant.

2.1. All information documents shall contain the following:

2.1.1. The general information set out in Part A of Appendix 3;

2.1.2. The information set out in Part B of Appendix 3, to identify the common design parameters of all engine types within an engine family or applicable to the engine type where not part of an engine family, intended for type approval;

2.1.3. The information set out in Part C of Appendix 3 following the format of the matrix set out in clause 2.1.3.1 to identify the items applicable to the parent engine or engine type and the engine types within the engine family, if applicable:

2.1.3.1. Engine type or engine family matrix with example data

Item Number	Item Description	Parent engine/ engine type	Engine types within the engine family (if applicable)			
			type 2	type 3	type ...	type n

3.1	Engine Identification					
3.1.1	Engine type designation	A01	A02	A03	A04	A05
3.2	Performance Parameters					
3.2.1	Declared rated speed(s) (rpm):	2200	2200	2000	1800	1800
3.10	Miscellaneous devices: Yes/No					
3.10.1	Exhaust gas recirculation (EGR)					
3.10.1.1	Characteristics (cooled/uncooled, high pressure/low pressure, etc.):					
...				

2.1.3.2. Reserved

2.1.3.3. In the case of constant speed engines with multiple rated speeds an additional set column(s) of data for each speed shall be recorded in paragraph 3.2 (Performance Parameters).

2.2. Explanatory notes on creation of information document:

2.2.1. Upon agreement of the approval authority, the information in paragraph 2.1.2 and 2.1.3 may be presented in an alternative format;

2.2.2. Each engine type or the parent engine in the matrix set out in paragraph 2.1.3.1 shall be identified in accordance with the engine family designation and engine type designation set out in paragraph 2.3.

2.2.3. Only those paragraphs of this Annex relevant for the particular engine family, engine types within the engine family or engine type shall be listed; in any case, the list shall adhere to the proposed numbering system,

2.2.4. Where several options separated by forward slash are given for an entry, the unused options shall be struck out, or only the used option(s) shall be shown;

2.2.5. When the same value for or description of a certain engine characteristic applies for several or all members of an engine family the corresponding cells may be merged.

2.2.6. Where a picture, diagram or detailed information is required, a reference to an appendix may be given;

2.2.7. Where a 'type' of a component is requested, the information supplied shall uniquely identify the component; this may be a list of characteristics, a manufacturers' name and part or drawing number, a drawing, or a combination of the aforementioned or other methods that achieves the same result.

2.3. Engine type designation and engine family designation

2.3.1. Engine family designation shall be as per ISO 8178-7 guidelines; however, engine type designation is at the choice of manufacturer.

2.3.2. The manufacturer shall not use the same engine family designation to identify more than one engine family

Appendix – A.2

Confidential information on emission control strategy

A 2.0 Confidential Information on emission control technology

A.2.1. This Appendix shall apply to electronically controlled engines, which use electronic control to determine both the quantity and timing of injecting fuel.

A.2.2. Additional information shall be presented to the test agency but not annexed to the application for type approval. This information shall include all the parameters modified by any auxiliary emission control strategy and the boundary conditions under which this strategy operates and in particular:

- (a) a description of the control logic, of timing strategies and switch points, during all modes of operation for the fuel and other essential systems, resulting in effective emission control (such as exhaust gas recirculation (EGR) or reagent dosing);
- (b) a justification for the use of any auxiliary emission control strategy applied to the engine, accompanied by material and test data, demonstrating the effect on exhaust emissions. This justification may be based on test data, sound engineering analysis, or a combination of both;
- (c) a detailed description of algorithms or sensors (where applicable) used for identifying, analysing, or diagnosing incorrect operation of the NO_x control system;
- (d) reserved

A.2.3. The additional information required in paragraph A.2.2 shall be treated as strictly confidential. It shall be retained by the manufacturer and made available for inspection by the Type Approval Authority at the time of type approval or upon request at any time during the validity of the type approval. In this case, the Type Approval Authority shall treat this information as confidential and shall not disclose it to other parties.

Appendix – A.3

Template for submission of engine technical specification

PART A

- 1. GENERAL INFORMATION**
- 1.1. Make (trade name(s) of manufacturer):
- 1.2. Commercial /Brand Name name(s) (if applicable):
- 1.3. Company name and address of manufacturer:
- 1.4. Name and address of manufacturer's authorised representative (if any):
- 1.5. Name(s) and address(es) of assembly/manufacture plant(s):
- 1.6. Engine type designation/engine family designation/FT:
- 1.7. Category Constant speed or variable speed:
- 1.8. Reserved
- 1.9. Reserved
- 1.10. Reserved
- 1.11. Rated Power
- 1.12. Test cycle: D1 3-Mode Steady State cycle discrete-mode type / RMC type
- 1.13. Reserved
- 1.14. Restrictions on use (if applicable):

PART B

- 2. COMMON DESIGN PARAMETERS OF ENGINE FAMILY (1)**
- 2.1. Combustion Cycle: four stroke cycle/two stroke cycle/other (specify):
- 2.2. Ignition Type: Positive ignition:
- 2.3. Configuration of the cylinders:
- 2.3.1. Position of the cylinders in the block: Single/V/in-line/opposed/radial/other(specify):
- 2.3.2. Bore centre to centre dimension (mm):
- 2.4. Combustion chamber type/design
- 2.4.1. Open chamber/divided chamber/other(specify):
- 2.4.2. Valve and porting configuration:
- 2.4.3. Number of valves per cylinder:
- 2.5. Range of swept volume per cylinder (cm³):
- 2.6. Main Cooling medium: Air/Water/Oil:
- 2.7. Method of air aspiration: naturally aspirated/pressure charged/pressure charged with charge cooler:
- 2.8. Fuel:

- 2.8.1. Fuel Type: (Natural gas/Biomethane) / LPG / Any other alternate fuel as specified in this document
- 2.8.1.1. Reserved.
- 2.8.2. Fuelling arrangement: Dedicated / Bi -Fuel
- 2.8.3. List of additional fuels, fuel mixtures or emulsions compatible with use by the engine declared by the manufacturer in accordance with Appendix 3 to paragraph 5 of this Regulation (provide reference to recognised standard or specification):
- 2.8.4. Lubricant added to fuel: Yes/No
- 2.8.5. Fuel supply type: Pump (high pressure) line and injector/in-line pump or distributor pump/Unit injector/ Common rail./ Any other
- 2.9. Engine management systems: mechanical/electronic control strategy
- 2.10. Miscellaneous devices: Yes/No (if yes provide a schematic diagram of the location and order of the devices)
- 2.10.1. Exhaust gas recirculation (EGR): Yes/No (if yes, complete section 3.10.1 and provide a schematic diagram of the location and order of the devices)
- 2.10.2. Water injection: Yes/No (if yes, complete section 3.10.2 and provide a schematic diagram of the location and order of the devices)
- 2.10.3. **Air injection: Yes/No (if yes, complete section 3.10.3 and provide a schematic diagram of the location and order of the devices)**
- 2.10.4. Others: Yes/No (if yes specify, complete section 3.10.4 and provide a schematic diagram of the location and order of the devices):
- 2.11. Exhaust after-treatment system: Yes/No (if yes provide a schematic diagram of the location and order of the devices)
- 2.11.1. Oxidation catalyst: Yes/No
(if yes, complete section 3.11.2)
- 2.11.2. De NO_x system with selective reduction of NO_x (addition of reducing agent): Yes/No
(if yes, complete section 3.11.3)
- 2.11.3. Other De NO_x systems: Yes/No
(if yes, complete section 3.11.3)
- 2.11.4. Reserved
- 2.11.5. Reserved
- 2.11.5.1. Reserved
- 2.11.6. Reserved
- 2.11.6.1. Reserved
- 2.11.7. Reserved
- 2.11.8. Reserved
- 2.11.9. Reserved

PART C

Item Number	Item Description	Parent engine/ engine type	Engine types within the engine family (if applicable)				Explanatory notes (not included in document)
			type 2	type 3	...	type n	
3.1.	Engine Identification						
3.1.1.	Engine type designation						
3.1.2.	Engine type designation shown on engine marking: yes/no						
3.1.3.	Location of the statutory marking:						
3.1.4.	Method of attachment of the statutory marking:						
3.1.5.	Drawings of the location of the engine identification number (complete example with dimensions):						
3.2.	Performance Parameters						
3.2.1.	Declared rated speed(s) (rpm):						
3.2.1.1.	Declared rated gross power (kW):						
3.2.1.2.	Fuel delivery/stroke (mm ³) for diesel engine, fuel flow (g/h) for other engines, at rated gross power						
3.2.6.	Idle speed (rpm)						
3.2.7.	No load speed (rpm):						
3.2.8.	Overload load speed (rpm): %Overload Power load %: eg.10%						
3.3.	Run-in procedure						Optional at choice of manufacturer
3.3.1.	Run-in time:						
3.3.2.	Run-in cycle:						
3.4.	Engine test						
3.4.1.	Specific fixture required: Yes/No						For NRSh only
3.4.1.1	Description, including photographs and/or drawings, of the system for mounting the engine on the test bench including the power transmission shaft for connection to the dynamometer:						
3.4.2.	Exhaust mixing chamber permitted by manufacturer: Yes/No						For NRSh only
3.4.2.1.	Exhaust mixing chamber description, photograph and/or drawing:						If applicable
3.4.3.	Pre-conditioning for: Steady-state operation						
3.5.	Lubrication system						
3.5.1.	Lubricant temperature						If applicable
3.5.1.1.	Minimum (°C):						
3.5.1.2.	Maximum (°C):						
3.6.	Combustion Cylinder						
3.6.1.	Bore(mm):						
3.6.2.	Stroke(mm):						
3.6.3.	Number of cylinders:						

Item Number	Item Description	Parent engine/ engine type	Engine types within the engine family (if applicable)				Explanatory notes (not included in document)
			type 2	type 3	...	type n	
3.6.4.	Engine total swept volume (cm ³):						
3.6.5.	Swept volume per cylinder as % of parent engine:						If engine family
3.6.6.	Volumetric compression ratio:						Specify tolerance
3.6.7.	Combustion system description:						
3.6.8.	Drawings of combustion chamber and piston crown:						
3.6.9.	Minimum cross-sectional area of inlet and outlet ports (mm ²):						
3.6.10.	Valve timing						
3.6.10.1.	Maximum lift and angles of opening and closing in relation to dead centre or equivalent data:						
3.6.10.2.	Reference and/or setting range:						
3.6.10.3.	Variable valve timing system: Yes/No						If applicable and where intake and/or exhaust
3.6.10.3.1.	Type: continuous/(on/off)						
3.6.10.3.2.	Cam phase shift angle:						
3.6.11.	Porting configuration						2-stroke only, if applicable
3.6.11.1.	Position, size and number:						
3.7.	Cooling system						Complete relevant section
3.7.1.	Liquid cooling						
3.7.1.1.	Nature of liquid:						
3.7.1.2.	Circulating pumps: Yes/No						
3.7.1.2.1.	type(s):						
3.7.1.2.2.	Drive ratio(s):						If applicable
3.7.1.3.	Minimum coolant temperature at outlet (°C):						
3.7.1.4.	Maximum coolant temperature at outlet (°C):						
3.8.	Aspiration						
3.8.1.	Maximum allowable intake depression at rated engine speed and at 100% load (kPa)						
3.8.1.1.	With clean air cleaner:						
3.8.1.2.	With dirty air cleaner:						
3.8.1.3.	Location, of measurement:						
3.8.2.	Pressure charger(s): Yes/No						
3.8.2.1.	Type(s):						
3.8.2.2.	Description and schematic diagram of the system (e.g. maximum charge pressure,-waste gate, VGT, Twin turbo, etc.):						
3.8.3.	Charge air cooler: Yes/No						

Item Number	Item Description	Parent engine/engine type	Engine types within the engine family (if applicable)				Explanatory notes (not included in document)
			type 2	type 3	...	type n	
3.8.3.1.	Type: air-air/air-water/other(specify)						
3.8.3.2.	Maximum charge air cooler outlet temperature at rated speed and 100% load (°C):						
3.8.3.3.	Maximum allowable pressure drop across charge cooler at rated engine speed and at 100% load (kPa):						
3.8.4.	Intake throttle valve: Yes/No						
3.8.5.	Device for recycling crankcase gases: Yes/No						
3.8.5.1.	If yes, description and drawings:						
3.8.5.2.	If no, compliance with paragraph 5.7. of this Regulation: Yes/No						
3.9.	Exhaust system						
3.9.1.	Description of the exhaust system (with drawings, photos and/or part numbers as required):						
3.9.2.	Maximum exhaust temperature (°C):						
3.9.3.	Maximum permissible exhaust backpressure at rated engine speed and at 100% load (kPa):						
	Maximum permissible exhaust backpressure at at each mode of test cycle (kPa): (This data is required for the engines with EGR) 100% Load: 75% Load: 50% Load: 25% Load: 10% Load:						
3.9.3.1.	Location of measurement:						
3.9.4.	Exhaust backpressure at loading level specified by manufacturer for variable restriction after-treatment at start of test (kPa):						
3.9.4.1.	Location and speed/load conditions:						
3.9.5.	Exhaust throttle valve: Yes/No						
3.10.	Miscellaneous devices: Yes/No						
3.10.1.	Exhaust gas recirculation (EGR)						
3.10.1.1.	Characteristics: cooled/uncooled, high pressure/low pressure/other (specify):						
3.10.2.	Water injection						
3.10.2.1.	Operation principle:						
3.10.3.	Air injection						
3.10.3.1.	Operation principle						
3.10.4.	Others						
3.10.4.1.	Type(s)						

Item Number	Item Description	Parent engine/ engine type	Engine types within the engine family (if applicable)				Explanatory notes (not included in document)
			type 2	type 3	...	type n	
3.11.	Exhaust after-treatment system						
3.11.1.	Location						
3.11.1.1.	Place(s) and maximum/minimum distance(s) from engine to first after-treatment device:						
3.11.1.2.	Maximum temperature drop from exhaust or turbine outlet to first after-treatment device (°C) if stated:						
3.11.1.2.1.	Test conditions for measurement:						
3.11.1.3.	Minimum temperature at inlet to first after-treatment device, (°C) if stated:						
3.11.1.3.1.	Test conditions for measurement:						
3.11.2.	Oxidation catalyst						
3.11.2.1.	Number of catalytic converters and elements:						
3.11.2.2.	Dimensions and volume of the catalytic converter(s):						<i>Or drawing</i>
3.11.2.3.	Total charge of precious metals (g):						
3.11.2.4.	Relative concentration of each compound (%):						
3.11.2.5.	Substrate (structure and material):						
3.11.2.6.	Cell density:						
3.11.2.7.	Type of casing for the catalytic converter(s):						
3.11.3.	Catalytic exhaust after-treatment system for NO _x or three-way catalyst						
3.11.3.1.	Type:						
3.11.3.2.	Number of catalytic converters and elements:						
3.11.3.3.	Type of catalytic action :						
3.11.3.4.	Dimensions and volume of the catalytic converter(s):						<i>Or drawing</i>
3.11.3.5.	Total charge of precious metals (g):						
3.11.3.6.	Relative concentration of each compound (%):						
3.11.3.7.	Substrate (structure and material):						
3.11.3.8.	Cell density:						
3.11.3.9.	Type of casing for the catalytic converter(s):						
3.11.3.10.	Reserved						
3.11.3.10.1.	Reserved						
3.11.3.11.	Normal operating temperature range (°C):						
3.11.3.12.	Consumable reagent: Yes/No						
3.11.3.12.1.	Type and concentration of reagent needed for catalytic action:						
3.11.3.12.2.	Lowest concentration of the active ingredient present in the reagent that						

Item Number	Item Description	Parent engine/engine type	Engine types within the engine family (if applicable)				Explanatory notes (not included in document)
			type 2	type 3	...	type n	
	does not activate warning system (CD _{min}) (%vol):						
3.11.3.12.3.	Normal operational temperature range of reagent:						
3.11.3.12.4.	International standard:						If applicable
3.11.3.13.	NO _x sensor(s): Yes/No						
3.11.3.13.1.	Type:						
3.11.3.13.2.	Location(s)						
3.11.3.14.	Oxygen sensor(s): Yes/No						
3.11.3.14.1.	Type:						
3.11.3.14.2.	Location(s):						
3.11.4.	Reserved						
3.11.5.	Other after-treatment devices						
3.11.5.1.	Description and operation:						
3.11.6.	Reserved						
3.11.7.	Other devices or features						
3.11.7.1.	Type(s)						
3.12.	Fuel feed for liquid-fuelled CI or, where applicable,						
3.12.1.	Feed pump						
3.12.1.1.	Pressure (kPa) or characteristic diagram:						
3.12.2.	Injection system						
3.12.2.1.	Fuel Pump						
3.12.2.1.1.	Type(s):						
3.12.2.1.2.	Rated pump speed (rpm):						
3.12.2.1.3.	mm ³ per stroke or cycle at full injection at rated pump speed:						
3.12.2.1.4.	Reserved						
3.12.2.1.5.	Reserved						
3.12.2.1.6.	Characteristic diagram:						As alternative to entries 3.12.2.1.1. to 3.12.2.1.5.
3.12.2.1.7.	Method used: on engine/on pump bench						
3.12.2.2.	Injection timing						For Mechanical engines- static injection timing values BTDC For Electronic engines- calibration/software part number/ID number of the calibration map
3.12.2.2.1.	Injection timing curve:						Specify tolerance, if applicable
3.12.2.2.2.	Static Timing:						Specify tolerance

Item Number	Item Description	Parent engine/ engine type	Engine types within the engine family (if applicable)				Explanatory notes (not included in document)
			type 2	type 3	type ...	type n	
3.12.2.3.	Injection piping						
3.12.2.3.1.	Length(s) (mm):						
3.12.2.3.2.	Internal diameter (mm):						
3.12.2.4.	Common rail: Yes/No						
3.12.2.4.1.	Type:						
3.12.3.	Injector(s)						
3.12.3.1.	Type(s):						
3.12.3.2.	Opening pressure (kPa):						Specify tolerance
3.12.4.	ECU: Yes/No						
3.12.4.1.	Type(s):						
3.12.4.2.	Software calibration number(s):						
3.12.4.3.	Communication standard(s) for access to data stream information: ISO 27145 with ISO 15765-4 (CAN-based)/ISO 27145 with ISO 13400 (TCP/IP-based)/SAE J1939-73						
3.12.5.	Governor						
3.12.5.1.	Type(s):						
3.12.5.2.	Speed at which cut-off starts under full load:						Specify range, if applicable
3.12.5.3.	Maximum no-load speed:						Specify range, if applicable
3.12.5.4.	Idle speed:						Specify range, if applicable
3.12.6.	Cold-start system: Yes/No						
3.12.6.1.	Type(s):						
3.12.6.2.	Description:						
3.12.7.	Fuel temperature at the inlet to the fuel injection pump						
3.12.7.1.	Minimum (°C):						
3.12.7.2.	Maximum (°C):						
3.13.	Reserved						

Part D

Please refer below additional table for alternate fuel system:

Item Number	Item Description	Parent engine/ engine type	Engine types within the engine family (if applicable)				Explanatory notes (not included in document)
			type 1	Type 2	Type 3	Type n	
4.1	Details of Kit Manufacturer / Supplier / Installer						
4.1.1	Name of the Manufacturer						
4.1.2	Address						
4.1.3	Telephone No. & Fax No.						
4.2	Gas Kit Identification						
4.2.1	Identification No.						
4.2.2	Variants, if any						
4.2.3	Fuel system (Dedicated / Bi-Fuel /)						
4.2.4	Reserved						
4.2.5	Fuel (Gas Fuel (Specify Name of fuel)						
4.3	Solenoid Valve / Automatic shutoff valve						
4.3.1	Name of manufacturer						
4.3.2	Model Name / Identification No.						
4.3.3	Type						
4.3.4	Working pressure (kg/cm ²)						
4.3.5	Max test pressure (kg/cm ²)						
4.3.6	Approval reference (Test Report / Approval Number)						
4.4	High Pressure Regulator						
4.4.1	Name of manufacturer						
4.4.2	Model name / Identification No.						
4.4.3	Type						
4.4.4	Inlet pressure (kg/cm ²)						
4.4.5	Outlet pressure (kg/cm ²)						
4.4.6	No. of stages						
4.4.7	Approval reference (Test Report / TAC compliance with Date)						
4.5	Low Pressure Regulator						
4.5.1	Name of manufacturer						
4.5.2	Model name / Identification No.						
4.5.3	Type						
4.5.4	Inlet pressure (kg/cm ²)						
4.5.5	Outlet pressure (kg/cm ²)						
4.5.6	No. of stages						
4.5.7	Approval reference (Test Report / TAC compliance with Date)						
4.6	Zero Pressure Regulator						
4.6.1	Name of manufacturer						
4.6.2	Model name / Identification No.						
4.6.3	Type						
4.6.4	Inlet pressure (kg/cm ²)						
4.6.5	Outlet pressure (kg/cm ²)						
4.6.6	Approval reference (Test Report / TAC compliance with Date)						

Item Number	Item Description	Parent engine/ engine type	Engine types within the engine family (if applicable)				Explanatory notes (not included in document)
			type 1	Type 2	Type 3	Type n	
4.7	Vaporizer / Heat exchanger (for LNG)						
4.7.1	Name of manufacturer						
4.7.2	Model name / Identification No.						
4.7.3	Type						
4.7.4	Inlet pressure (kg/cm ²)						
4.7.5	Outlet pressure (kg/cm ²)						
4.7.6	Approval reference (Test Report / Approval Number)						
4.8	Filter						
4.8.1	Name of manufacturer						
4.8.2	Model name / Identification No.						
4.8.3	Type						
4.8.4	Inlet pressure (kg/cm ²)						
4.8.5	Outlet pressure (kg/cm ²)						
4.9	High Pressure Tubing						
4.9.1	Name of manufacturer						
4.9.2	Model name / Identification No.						
4.9.3	Type (rigid / flexible)						
4.9.4	Working pressure (kg/cm ²)						
4.9.5	Max. test pressure (kg/cm ²)						
4.9.6	Outer diameter / Inner Diameter (mm)						
4.9.7	Material						
4.9.8	Approval reference (Test Report / Approval Number)						
4.10	Low Pressure Tubing						
4.10.1	Name of manufacturer						
4.10.2	Model name / Identification No.						
4.10.3	Type						
4.10.4	Working pressure (kg/cm ²)						
4.10.5	Max test pressure (kg/cm ²)						
4.10.6	Outer diameter / Inner Diameter (mm)						
4.10.7	Material						
4.10.8	Approval reference (Test Report / Approval Number)						
4.11	Gas-Air Mixer						
4.11.1	Name of manufacturer						
4.11.2	Model name / Identification No						
4.11.3	Type & drawing						
4.11.4	Venturi Size (mm)						
4.11.5	Approval reference (Test Report / Approval Number)						
4.12	Gas Injector						
4.12.1	Name of manufacturer						
4.12.2	Model name / Identification No						
4.12.3	Type & drawing						
4.12.4	Injector flow specs						

Item Number	Item Description	Parent engine/ engine type	Engine types within the engine family (if applicable)				Explanatory notes (not included in document)
			type 1	Type 2	Type 3	Type n	
4.12.5	Approval reference (Test Report / Approval Number)						
4.13	Wiring Harness						
4.13.1	Name of manufacturer						
4.13.2	Electrical circuit diagram / Detail layout						
4.13.3	Approval reference (Test Report / Approval Number)						
4.14	Interfacing Unit (ECU)						
4.14.1	Name of manufacturer						
4.14.2	Identification No.						
4.14.3	Type						
4.15	Fuel selector switch						
4.15.1	Name of manufacturer						
4.15.2	Model No						
4.15.3	Type						
4.16	Fuel flow actuation mechanism (Mechanical / Electronic)						
4.16.1	Brief description of system (Attach Annexure)						
4.16.2	Schematic layout (Attach Drawing)						
4.16.3	Identification of critical components of Kit, including ECU, Lambda sensor, Pressure sensor, temperature Sensor etc with Make and Identification number (attach Annexure)						
4.17	Brief Description of System Including Dimensional Layout for kit components installation ventilation details etc.						
4.18	Joints and connections						
4.18.1	Name of manufacturer						
4.18.2	Type						
4.18.3	Number of Joints and connections represented on Drawing (Attach Drawing)						
4.19	Current limiting Device (Fuse)						
4.19.1	Name of manufacturer						
4.19.2	Identification No.						
4.19.3	Voltage / current rating						
4.19.4	Type						
4.19.5	Approval reference (Test Report / Approval Number)						
4.20	Indicator						
4.20.1	Pressure Indicator						
4.20.2	Name of manufacturer						
4.20.3	Identification No.						
4.20.4	Type						
4.20.5	Temperature Indicator (for LNG)						
4.20.6	Name of manufacturer						

Item Number	Item Description	Parent engine/ engine type	Engine types within the engine family (if applicable)				Explanatory notes (not included in document)
			type 1	Type 2	Type 3	Type n	
4.20.7	Identification No.						
4.20.8	Type						
4.21	Service shut off valve						
4.21.1	Name of manufacturer						
4.21.2	Identification No.						
4.21.3	Type						
4.22	Compartment/Sub-compartment / Gas tight housing						
4.22.1	Name of manufacturer						
4.22.2	Identification No						
4.22.3	Type						
4.22.4	Material used						
4.22.5	Approval reference (Test Report / Approval Number)						
4.23	Conduit						
4.23.1	Name of manufacturer						
4.23.2	Identification No.						
4.23.3	Inner & outer diameter						
4.23.4	Type						
4.23.5	Approval reference (Test Report / Approval Number)						
4.24	Battery cut off switch (if applicable)						
4.24.1	Name of manufacturer						
4.24.2	Identification No.						
4.24.3	Type						
4.25	Labels - Number and position						
4.26	Any other information						
	* Mention NA wherever not applicable						

Explanatory notes to Appendix 3:

(Footnote markers, footnotes, and explanatory notes not to be stated on the information document)

ANNEXURE – 2

Communication – Type Approval and COP Template to be attached here by Test Agencies

1. General

SECTION I

- 1.1. Make (trade name(s) of manufacturer):
- 1.2. Commercial name(s)/ Brand Name (if applicable):
- 1.3. Company name and address of manufacturer:
- 1.4. Name and address of manufacturer's authorised representative (if any):
- 1.5. Name(s) and address(es) of assembly/manufacture plant(s):
- 1.6. Engine type designation/engine family designation/FT:
- 1.7. Category and sub-category of the engine type/engine family:

SECTION II

1. Technical service responsible for carrying out the test(s):
2. Date(s) of the test report(s):
3. Number(s) of the test report(s):

SECTION III

The undersigned hereby certifies the accuracy of the manufacturer's description in the attached information document of the engine type/engine family ⁽²⁾ described above, for which one or more representative samples, selected by the approval authority, have been submitted as prototypes and that the attached test results apply to the engine type/engine family ⁽²⁾.

1. The engine type/engine family ⁽²⁾ meets/does not meet ⁽²⁾ the requirements laid down in GSR 804(E.) dated 3-Nov-2022 series of amendments.

2. The approval is granted/extended/refused/withdrawn ⁽²⁾

Place:

Date:

Name and signature:

Attachments:

Information folder

Test report(s)

All other documents added by the technical services or by the Type Approval Authority to the information folder in the course of carrying out their functions.

Approval number:

2. Common design parameters of the engine type/engine family

- 2.1. Combustion Cycle: four stroke cycle/two stroke cycle/rotary/other:
- 2.2. Ignition Type: Positive ignition
- 2.3.1. Position of the cylinders in the block: V/in-line/radial/other(describe) ⁽²⁾

- 2.6 Main Cooling medium: Air/Water/Oil ⁽²⁾
- 2.7. Method of air aspiration: naturally aspirated/pressure charged/pressure charged with charge cooler ⁽²⁾
- 2.8.1. Fuel Type(s): (Natural gas/Biomethane) / Alternate Fuel
- 2.8.1.1. Reserved
- 2.8.2. Fuelling arrangement: Dedicated / Bi-Fuel
- 2.8.3. List of additional fuels compatible with use by the engine declared by the manufacturer in accordance with paragraph A.3.1.2.3. of Annex 3 to paragraph 5 of this Regulation (provide reference to recognised standard or specification):
- 2.8.4. Lubricant added to fuel: Yes/No ⁽²⁾
- 2.8.5. Fuel supply type: Pump (high pressure) line and injector/in-line pump or distributor pump/Unit injector/ Common rail
- 2.9. Engine management systems: mechanical/electronic control strategy ⁽²⁾
- 2.10. Miscellaneous devices: Yes/No ⁽²⁾
- 2.10.1. Exhaust gas recirculation (EGR): Yes/No ⁽²⁾
- 2.10.2. Water injection: Yes/No ⁽²⁾
- 2.10.3. Air injection: Yes/No ⁽²⁾
- 2.10.4. Others (specify):
- 2.11. Exhaust after-treatment system: Yes/No ⁽²⁾
- 2.11.1. Oxidation catalyst: Yes/No ⁽²⁾
- 2.11.2. De NO_x system with selective reduction of NO_x (addition of reducing agent): Yes/No ⁽²⁾
- 2.11.3. Other De NO_x systems: Yes/No ⁽²⁾
- 2.11.4. Three-way catalyst combining oxidation and NO_x reduction: Yes/No
- 2.11.5. Reserved
- 2.11.6. Reserved
- 2.11.7. Reserved
- 2.11.8. Three-way catalyst combining oxidation and NO_x reduction: Yes/No
- 2.11.9. Other after-treatment devices (specify):
- 2.11.10. Other devices or features that have a strong influence on emissions (specify):

3. Essential characteristics of the engine type(s)

Item Number	Item Description	Parent Engine type	Engine types within the family (if applicable)		
3.1.1.	Engine Type Designation:				
3.1.2.	Engine type designation shown on engine mark: Yes/No				

Item Number	Item Description	Parent Engine Engine type	Engine types within the family /(if applicable)		
3.1.3.	Location of the manufacturer's statutory marking:				
3.2.1.	Declared rated speed (rpm):				
3.2.2.2.	Declared Rated Power (kW)				
3.2.3.2.	Declared Rated torque (Nm):				
3.6.3.	Number of Cylinders:				
3.6.4.	Engine total swept volume (cm ³):				
3.8.5.	Device for recycling crankcase gases: Yes/No				
3.11.3.12.	Reserved				
3.11.3.12.1.	Reserved				
3.11.3.13.	NO _x sensor(s): Yes/No				
3.11.3.14.	Oxygen sensor: Yes/No				
3.11.4.7.	Fuel borne catalyst (FBC): Yes/No				
Conditions to be respected in the installation of the engine on Genset					
3.8.1.1.	Maximum allowable intake depression at rated engine speed and at 100% load (kPa) with clean air cleaner:				
3.8.3.2.	Maximum charge air cooler outlet temperature at rated speed and 100% load (deg. C):				
3.8.3.3.	Maximum allowable pressure drop across charge cooler at rated engine speed and at 100% load (kPa) (if applicable):				
3.9.3.	Maximum permissible exhaust gas back-pressure at rated engine speed and at 100% load (kPa):				
	Maximum permissible exhaust backpressure at each mode of test cycle (kPa): (This data is required for the engines with EGR) 100% Load: 75% Load: 50% Load: 25% Load: 10% Load:				
3.9.3.1.	Location of measurement:				

Item Number	Item Description	Parent Engine Engine type	Engine types within the family /(if applicable)		
3.11.1.2	Maximum temperature drop from exhaust system or turbine outlet to first exhaust after-treatment system (deg. C) if stated:				
3.11.1.2.1.	Test conditions for measurement:				

4. Cycle emission results

Emissions	CO (g/kWh)	HC (g/kWh)	NO _x (g/kWh)	HC+ NO _x (g/kWh)	Test Cycle ⁽⁴⁾
DF incorporated adjusted emission result before rounding					
Final rounded certificate result with DF.					

CO₂ result:

(CO₂ g/kWh is only for the documentation purpose & does not have any impact on pass or fail criteria the engine)

Explanatory notes to Annex 2

(Footnote markers, footnotes, and explanatory notes not to be stated on the type-approval certificate)

- (1) Distinguishing number of the contracting party which has granted/extended/refused/withdrawn an approval.
- (2) Strike out the unused options, or only show the used option(s).
- (3) Indicate the applicable option for the category and sub-category in accordance with entry 1.7. of the information document set out in Part A of Appendix 3 to Annex 1.
- (4) Indicate the used test cycle as prescribed in Annexure 7 to this Regulation.

Appendix – A.1 Test Report

A.1.1. General requirements

One test report shall be completed for each test required for the type-approval. Each additional (e.g. a second speed on a constant speed engine) or supplementary test (e.g. another fuel is tested) will require an additional or supplementary test report.

A.1.2. Explanatory notes on creation of a test report

- A.1.2.1. A test report shall contain at least the information set out in paragraph A.1.3.
- A.1.2.2. Notwithstanding paragraph A.1.2.1, only those sections or sub-sections relevant for the particular test and for the particular engine family, engine types within the engine family or engine type tested need to be stated in the test report
- A.1.2.3. The test report may contain more information than that requested in paragraph A.1.2.1 but in any case, shall adhere to the proposed numbering system;
- A.1.2.4. Where several options separated by forward slash are given for an entry, the unused options shall be struck out, or only the used option(s) shall be shown;
- A.1.2.5. Where a 'type' of a component is requested, the information supplied shall uniquely identify the component; this may be a list of characteristics, a manufacturers' name and part or drawing number, a drawing, or a combination of the aforementioned or other methods that achieves the same result.
- A.1.2.6. The test report may be delivered on paper or in an electronic format agreed between the manufacturer, technical service and Type Approval Authority.

A.1.3 Template for the test report

1. General Information

- 1.1. Make(s) (trade name(s) of manufacturer):
- 1.2. Commercial name(s) /Brand Name_(if applicable):
- 1.3. Company name and address of manufacturer:
- 1.4. Name of test agency:
- 1.5. Address of test agency:
- 1.6. Location of test:
- 1.7. Date of test:
- 1.8. Test report number:
- 1.9. Information document reference number (if available):
- 1.10. Test report type: Primary test/additional test/supplementary test
 - Primary test -standard regular test most likely common for approval.*
 - Additional test - additional test is for in case there are more than one options for permeance/emission related components, i.e. 2 different make injector, 2 turbo etc.*
- 1.10.1. Description of the purpose of the test:

2. General engine information (test engine)

- 2.1. Engine type designation/engine family designation/FT:
- 2.2. Engine identification number:
- 2.3. Engine Category and subcategory:

3. Documentation and information Check list (primary test only)

- 3.1. Engine mapping documentation reference:
- 3.2. Deterioration factor determination documentation reference:
- 3.3. Reserved
- 3.4. NO_x control diagnostic demonstration documentation reference, where applicable:
- 3.5. Reserved
- 3.6. For engine types and engine families that use an ECU as part of the emission control system anti-tampering declaration documentation reference:
- 3.7. For engine types and engine families that use mechanical devices as part of the emission control system anti- tampering and adjustable parameters declaration and demonstration documentation reference:

4. Reference fuel(s) used for test (complete relevant subparagraph(s))

4.2. Fuels for spark ignition engine

- 4.2.1. Make:
- 4.2.2. Type:
- 4.2.3. Octane number:
- 4.2.4. Fame content (%):
- 4.2.5. Density at 15 °C (kg/m³):

4.3. Reserved

4.4. Reserved

4.5. Reserved

4.5.1. Reserved

5. Lubricant

- 5.1. Make(s):
- 5.2. Type(s):
- 5.3. SAE viscosity:
- 5.4. Lubricant and fuel are mixed: yes/no
- 5.4.1. Percentage of oil in mixture:

6. Engine Speed

- 6.1. Declared rated speed:
 - 6.1.1. Overload speed:
 - 6.1.2. Idle speed:

7. Engine Power.

8. Conditions at test

8.1. f_a within range 0.93 to 1.07: Yes/No

8.1.1. If f_a is not within specified range state altitude of test facility and dry atmospheric pressure:

If no - If these limits are exceeded, the corrected value obtained shall be given and the test conditions (temperature and pressure) shall be stated precisely in the test report

8.2. Applicable intake air temperature range: 20 to 30 °C (up 560kW/ 20 to 35 °C (greater than 560 kW only)

9. Test result 9.1. 3-mode cycle Emissions results

9.2. Deterioration Factor (DF): calculated/assigned

9.2.1. DF values and the cycle weighted emissions results to be stated in Table 6:

Note: In the event that a discrete mode 3-mode cycle is run where the K_{ru} or K_{rd} factors have been established for individual modes then a table showing each mode and the applied K_{ru} or K_{rd} should replace the shown table.

**Table 6
3-mode cycle DF values and weighted emissions results**

DF mult/add	CO	HC	NO _x	HC+ NO _x
Emissions	CO (g/kWh)	HC (g/kWh)	NO _x (g/kWh)	HC+ NO _x (g/kWh)
Test result with/without regeneration				
k_{ru}/k_{rd} mult/add				
Final rounded test result with DF				

9.3 Cycle weighted CO₂ (g/kWh):

9.3.1 Cycle average NH₃ (ppm):

9.4. Reserved

Table 7

Reserved

9.5. Sampling systems used for the 3-mode emission test:

9.5.1. Gaseous emissions:

9.5.2. Reserved

9.5.2.1. Reserved

10. Final emissions results

10.1 Cycle emissions results to be stated in Table 8.

Table 8
Final emissions results

Emissions	CO (g/kWh)	HC (g/kWh)	NO _x (g/kWh)	HC+ NO _x (g/kWh)	Test Cycle ⁽¹⁾
3-mode cycle final rounded test result with DF.					

10.2 CO₂ result:

Explanatory notes to the test report template

(Footnote markers, footnotes, and explanatory notes not to be stated on the test report)

- (1) For test cycle note the cycle indicated in Appendix 1 of Annexure 7
- (2) Copy the results from table 6
- (3) Reserved
- (4) For an engine tested on a 3-mode cycle indicate the CO₂ emissions values given in that cycle from paragraph 9.3.

ANNEXURE – 3

Labelling Requirements

A3.1. The engine or the product must be affixed with a conformance label meeting the following requirements.

A3.1.1. General Requirement

- e. The label shall be durable and legible;
- f. The label shall be affixed on a part necessary for normal operation of the engine or the product and not normally requiring replacement during the life of the engine or the product;
- g. Statement that 'this engine or product conforms to the Environment Protection Rule 1986;
- h. All the information mentioned in the conformance label must be in English language;

A3.1.2. Conformance Labelling Content Requirement

- i. Name the engine manufacturer or the engine or product importer
- j. Manufacturing plant address from where engine is manufacture
- k. Engine Model name;
- l. Rated speed and corresponding gross power in kW;
- m. Engine Unique Identification Number (Serial Number, etc.);
- n. Date of manufacturing and in case of import, date of import of engine or Genset product;
- o. Type Approval certificate number;
- p. Letter 'G' to denote that the engine is belongs to genset application. The Letter 'G' shall be engraved on the conformance label. The letter(s) should have a minimum size of 7 mm.

Compliance name plate model

Manufacturer	<input type="text"/>	 COMPANY LOGO	G		
Mfg. Plant	<input type="text"/>				
Engine Model	<input type="text"/>	Rated Speed (rpm)	<input type="text"/>	Power (kW)	<input type="text"/>
Engine Sr No	<input type="text"/>	Date of Mfg.	<input type="text"/>		
Type Approval Cert. No.	<input type="text"/>				
This engine or product conforms to the Environment Protection Rule 1986					

ANNEXURE – 4

Test equipment, test bed measurement system and test facility

A4.1 Requirement

A4.1.1 **Test facility:** The test facility to be used shall be of the certification agencies or any other facility approved by these certification agencies. The test Lab at Test Agency/ Engine Manufacturer Lab/ Third party Lab shall be accredited as per the requirement of ISO/IEC-17025 (NABL-National Accreditation Board for Testing and Calibration Laboratory) compliance for the related GSR/S&P/ISO-8178 Standards. The tests shall be carried out under the control of the certification agencies.

A4.1.2 **Test bed measurement system and equipment:** Test bed measurement system and equipment's of gaseous and particulate shall be as per the guideline given in the ISO-8178-1: 2017,2020 Reciprocating internal combustion engines — Exhaust emission measurement — Part 1: Test-bed measurement systems of gaseous and particulate emission.

ANNEXURE-5

Data evaluation, test result calculation of gaseous & emission, test execution and measurement procedures

A5.1 Requirement

A5.1.1 Method of test execution, measurement procedures, data evaluation and calculation of gaseous emission shall be as per the guideline given in the ISO-8178-4: 2017, 2020 Reciprocating internal combustion engines — Exhaust emission measurement — Part 4: Steady-state and transient test cycles for different engine applications

A5.1.2 Reserved

A5.1.3 1980 international gravity formula

The acceleration of Earth's gravity, a_g , varies depending on the location and a_g is: calculated for a respective latitude, as follows

$$a_g = 9.7803267715 \left[1 + 5.2790414 \times 10^{-3} \sin^2 \theta + 2.32718 \times 10^{-5} \sin^4 \theta + 1.262 \times 10^{-7} \sin^6 \theta + 7 \times 10^{-10} \sin^8 \theta \right]$$

Where: θ = Degrees north or south latitude

Note: Reference taken from AIS-137

ANNEXURE – 6

Technical characteristics of fuels prescribed for approval tests and to verify conformity of production tests

Appendix – 1 & Table 1

Reserved

Appendix – 2 & Table 2

Reserved

Appendix – 3 & Table 3

Reserved

Appendix – 4 Alternate Fuel Specification

2.0 Technical data on gaseous fuels for single fuel engines

2.1 Type: LPG

Table 4

LPG				
<i>Parameter</i>	<i>Unit</i>	<i>Fuel A</i>	<i>Fuel B</i>	<i>Test method</i>
Composition:				EN 27941
C ₃ -content	per cent v/v	30 ± 2	85 ± 2	
C ₄ -content	per cent v/v	Balance ¹	Balance ¹	
< C ₃ , > C ₄	per cent v/v	Maximum 2	Maximum 2	
Olefins	per cent v/v	Maximum 12	Maximum 15	
Evaporation residue	mg/kg	Maximum 50	Maximum 50	EN 15470
Water at 0 °C		Free	Free	EN 15469
Total sulphur content including odorant	mg/kg	Maximum 10	Maximum 10	EN 24260, ASTM D 3246, ASTM 6667
Hydrogen sulphide		None	None	EN ISO 8819
Copper corrosion strip (1h at 40 °C)	Rating	Class 1	Class 1	ISO 6251 ²

Odour		Characteristic	Characteristic	
Motor octane number ³		Minimum 89.0	Minimum 89.0	EN 589 Annex B
Notes: ¹ Balance shall be read as follows: balance = 100 - C ₃ - <C ₃ - >C ₄ . ² This method may not accurately determine the presence of corrosive materials if the sample contains corrosion inhibitors or other chemicals which diminish the corrosivity of the sample to the copper strip. Therefore, the addition of such compounds for the sole purpose of biasing the test method is prohibited. ³ At the request of the engine manufacturer, a higher MON could be used to perform the type approval tests.				

2.2. Type: Natural Gas/ Bio-methane

2.2.1. Specification for reference fuels supplied with fixed properties (eg from a sealed container)

As an alternative to the reference fuels set out in this paragraph, the equivalent fuels in paragraph 2.1.2. of this Annex may be used

Table 5

Natural Gas/ Bio-methane					
Characteristics	Units	Basis	Limits		Test method
			minimum	maximum	
Reference fuel G_R					
Composition:					
Methane		87	84	89	
Ethane		13	11	15	
Balance ¹	per cent mole	—	—	1	ISO 6974
Sulphur content	mg/m ³ ²	—	—	10	ISO 6326-5
Notes: ¹ Inerts + C ₂₊ ² Value to be determined at standard conditions 293.2 K (20 °C) and 101.3 kPa.					
Reference fuel G₂₃					
Composition:					
Methane		92.5	91.5	93.5	
Balance ¹	per cent mole	—	—	1	ISO 6974
N ₂	per cent mole	7.5	6.5	8.5	
Sulphur content	mg/m ³ ²	—	—	10	ISO 6326-5
Notes: ¹ Inerts (different from N ₂) + C ₂₊ C ₂₊ ² Value to be determined at 293.2 K (20 °C) and 101.3 kPa.					
Reference fuel G₂₅					
Composition:					

Methane	per cent mole	86	84	88	
Balance ¹	per cent mole	—	—	1	ISO 6974
N ₂	per cent mole	14	12	16	
Sulphur content	mg/m ³ ²	—	—	10	ISO 6326-5
<i>Notes:</i>					
¹ Inerts (different from N ₂) + C ₂ + C ₂₊					
² Value to be determined at 293.2 K (20 °C) and 101.3 kPa.					
Reference fuel G₂₀					
Composition:					
Methane	per cent mole	100	99	100	ISO 6974
Balance ⁽¹⁾	per cent mole	—	—	1	ISO 6974
N ₂	per cent mole				ISO 6974
Sulphur content	mg/m ³ ⁽²⁾	—	—	10	ISO 6326-5
Wobbe Index (net)	MJ/m ³ ⁽³⁾	48.2	47.2	49.2	
⁽¹⁾ Inerts (different from N ₂) + C ₂ + C ₂₊ .					
⁽²⁾ Value to be determined at 293.2 K (20 °C) and 101.3 kPa.					
⁽³⁾ Value to be determined at 273.2 K (0 °C) and 101.3 kPa.					
Note –					
In absence of availability of reference fuel for testing, commercial available fuel as notified under CMVR (ammended time to time) shall be used for testing					

2.2.2. Specification for reference fuel supplied from a pipeline with admixture of other gases with gas properties determined by on-site measurement

As an alternative to the reference fuels in this paragraph the equivalent reference fuels in paragraph 2.2.1. of this Annex may be used.

2.2.2.1. The basis of each pipeline reference fuel (GR, G20, ...) shall be gas drawn from a utility gas distribution network, blended, where necessary to meet the corresponding lambda-shift (S_λ) specification in Table A.5-1, with an admixture of one or more of the following commercially (the use of calibration gas for this purpose shall not be required) available gases:

- (a) Carbon dioxide;
- (b) Ethane;
- (c) Methane;
- (d) Nitrogen;
- (e) Propane.

2.2.2.2. The value of S_λ of the resulting blend of pipeline gas and admixture gas shall be within the range specified in Table A.5-1 for the specified reference fuel.

Table A.5-1
Required range of S_λ for each reference fuel

Reference fuel	Minimum S _λ	Maximum S _λ
----------------	------------------------	------------------------

G_{R^2}	0.87	0.95
G_{20}	0.97	1.03
G_{23}	1.05	1.10
G_{25}	1.12	1.20
¹ The engine shall not be required to be tested on a gas blend with a Methane Number (MN) less than 70. In the case that the required range of S_{λ} for G_R would result in an MN less than 70 the value of S_{λ} for G_R may be adjusted as necessary until a value of MN no less than 70 is attained.		

2.2.2.3. The engine test report for each test run shall include the following:

- (a) The admixture gas(es) chosen from the list in paragraph 2.2.2.1. of this Annex;
- (b) The value of S_{λ} for the resulting fuel blend;
- (c) The Methane Number (MN) of the resulting fuel blend.

2.3 Fuels and their applicable standards:

Refer the applicable standards amended time to time for the fuels

Sr. No.	Fuel	Applicable Standard
1	Natural Gas	Annexure IV - L - CMVR Refer rule 115 H
2	Bio methane	IS 16087: 2016
3	Bio Gas	IS 16087: 2016
4	LPG	IS 14861 : 2000 (REAFFIRMED 2020)
5	E10	IS 2796: 2017
6	E12	IS 17586: 2021
7	E15	IS 17586: 2021
8	E20	IS 17021: 2018
9	E85	IS 16634: 2017
10	E100	IS 15464: 2004
11	M15	IS 17076: 2019
12	M85	Annexure ZB - CMVR Refer rule 115 H
13	M100	IS 17075 : 2019
14	Hydrogen	IS 16061: 2021
15	Hydrogen blended with CNG (18% hydrogen)	IS 17314 : 2019

ANNEXURE – 7

Requirements, Tests and Test Procedures

7.1. General

Engines shall be designed, constructed and assembled so as to enable them to comply with the provisions of this Regulation.

7.1.1. The technical measures taken by the manufacturer shall be such as to ensure that the gaseous pollutant emissions are effectively limited, as set out in Table 1 of clause 3 of this Regulation throughout the emission durability period of the engine, as set out in Appendix 6 to this Annexure 7, and under normal conditions of use.

7.1.1.1. For this purpose, the engine final emission test result calculated according to the requirements of clause 7.1.2 shall not exceed the exhaust emission limits set out in Table 1 of clause 3, when:

- (a) tested in accordance with the test conditions and detailed technical procedures set out in Annexure 5 to this Regulation,
- (b) using the fuel(s) specified in paragraph 7.1.3.
- (c) using the test cycles specified in Appendix 1 to Annexure 7 of this Regulation.

7.1.2 The final exhaust emission test results for engines subject to this Regulation shall be calculated by applying all of the following to the laboratory test results:

- (a) the emissions of crankcase gases as required by Appendix 5 of Annexure 7;
- (b) any necessary adjustment factor, where the engine includes an infrequently regenerating exhaust after-treatment system;
- (c) in respect of all engines, as a final step in the calculation, deterioration factors appropriate to the emission durability periods specified in Appendix 6 to this Annexure 7 and calculated according to the prescription set out in Annexure 5.

7.1.3 In accordance to Annexure 7 of this Regulation, the testing of an engine type or engine family to determine whether it meets the emission limits set out in this Regulation shall be carried out by using the following reference fuels or fuel combinations, as appropriate:

- (a) natural gas/bio methane
- (b) ethanol.
- (c) methanol

The engine type or engine family shall, in addition, meet the exhaust emission limits set out in this Regulation in respect of any other specified fuels, fuel mixtures or fuel emulsions included by a manufacturer in an application for type- approval and described in the Appendix 11 to paragraph 7 of this Regulation.

7.1.4 As regards the conduct of measurements and tests, the technical requirements shall be met in respect of:

- (a) apparatus and procedures for the conduct of tests;
- (b) apparatus and procedures for emission measurement and sampling;
- (c) methods for data evaluation and calculations;
- (d) methods for establishing deterioration factors;
- (e) methods for taking account of emissions of crankcase gases;
- (f) methods for determining and taking account of continuous or infrequent regeneration of exhaust after-treatment systems;

(g) Reserved

- 7.1.5. Any adjustment, repair, disassembly, cleaning or replacement of engine components or systems which are scheduled to be performed on a periodic basis to prevent malfunction of the engine, shall only be done to the extent that is technologically necessary to ensure proper functioning of the emission control system.
- 7.2. Reserved
- 7.3. The technical requirements relating to emission control strategies as set out in Annexure 8 to this regulation shall apply;
- 7.4. The use of defeat strategies shall be prohibited;
- 7.5. Engine types and engine families shall be designed and fitted with emission control strategies in such a way as to prevent tampering to the extent possible;

Appendix – 1

Emission Test Cycles Introduction

1. Test cycles

The type-approval test shall be conducted using test cycle as specified in Table A for constant speed speed application.

1.1 Steady-state test cycles

Steady-state test cycles are specified in below clause 2 of this Appendix as a list of discrete modes (operating points), where each operating point has one value of speed and one value of torque. A steady-state test cycle shall be measured with a warmed up and running engine according to manufacturer's specifications

1.2. Steady-state discrete mode test cycles

The steady-state discrete mode test cycles are hot running cycles where emissions shall be started to be measured after the engine is started, warmed up and running as per specified boundary conditions. Each cycle consists of a number of speed and load modes (with the respective weighing factor for each mode) which cover the typical operating range of the specified engine category.

1.3. Steady-state ramped mode test cycles

Steady-state ramped mode test cycles are hot running cycles where emissions shall be started to be measured after the engine is started, warmed up and running as per specified boundary conditions. Test cycle with a sequence of steady state engine test modes with defined speed and torque criteria at each mode and defined speed and torque ramps between these modes.

2. Characteristics of the steady-state test cycles

2.1. Test cycles applicable to Genset engine categories are set out in Table A

Table A-Test cycles

Test cycles for Genset engine categories			
Category	Speed operation	Purpose	Test Cycle
Genset	Constand speed engine	Constant speed engine upto 800 kW	D1 3-mode Steady-state discrete mode test cycle specified in ISO-8178-Part 4, OR D1 3-mode Steady-state ramped mode test cycle specified in ISO-8178-Part 4

2.2. Steady-state constant speed and test cycles:

The detailed description of the test modes and weighting factors for the steady-state discrete-mode genset engine is are set out in Tables B.

2.2.1 Constant Speed test Cycle

Table B- Discrete D1 test modes

Test modes and weighting factors			
Mode number (cycle D1)	1	2	3
Speed (a)	100%		
Torque (b) (%)	100	75	50

Weighting factor	0.3	0.5	0.2
Mode length (Second)	600	600	600

(a) Rated speeds as declared by manufacturer
(b) per cent torque is relative to the torque corresponding to the rated gross power declared by the manufacturer. Considering the applicable power tolerance, the torque setting for 2 & 3 mode, shall be based on actual torque measured at 1st mode during test.

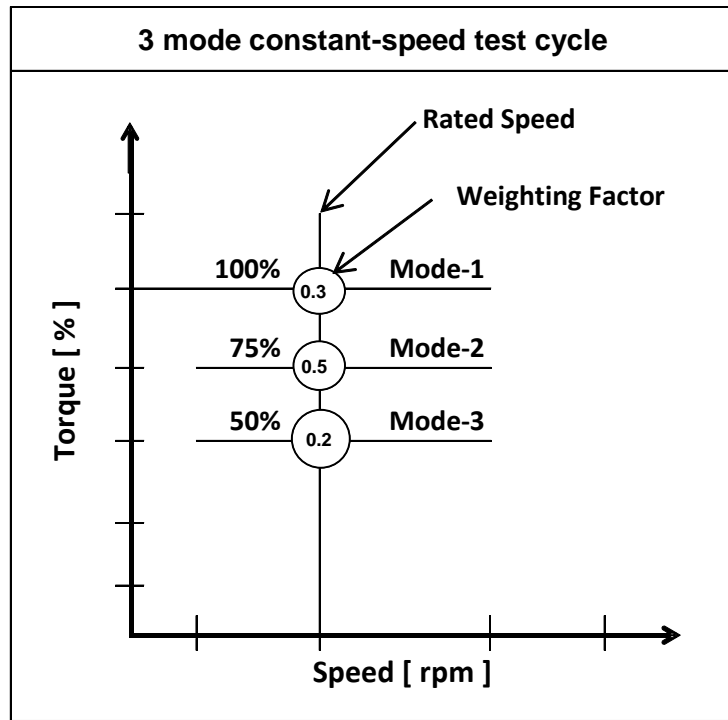

Table C
Reserved

2.2.2 Reserved

Table D, E & F
Reserved

Note: Reference
ISO 8178-4:2017,2020;
Reciprocating internal combustion engines — Exhaust emission measurement — Part 4: Steady-state and transient test cycles for different engine applications.

Appendix – 2
Reserved

A2.1, A2.2, A2.3, A2.4 and A2.5 - Reserved

Appendix – 3
Reserved

A3.1, A3.2, A3.3, A3.4, A3.4 - Reserved

Appendix – 4

Gross Power Measurement Procedure

- 1.0 Declared power (kWm) means rated gross mechanical power declared by manufacturer for type approval at declared rated speed.
- 2.0 Gross observed power shall be the criteria for adjusting dynamometer load as well as calculating the specific emission values
- 3.0 The declared rated gross power shall be verified with the observed gross corrected power as mentioned below. Certification Power verification will be at reference atmospheric condition.
- 4.0 Power observed in the emission test cycle for all test mode points shall be corrected as per mentioned below formula and 1st mode corrected power is the corrected rated gross power.
- 5.0 Power Corrections Factors:

Definition: The power correction factor is the coefficient by which the measured power must be multiplied to determine the engine power under the reference atmospheric conditions specified as below

$$P_{\text{corr}} = \alpha P_{\text{obs}}$$

Where,

P_{corr} is the corrected power (i.e. power under reference atmospheric conditions)

α is the correction factor

P_{obs} is the measured power (test power)

Reference atmospheric conditions:

- Temperature (T): 298 K
- Dry pressure (Ps): 99 kPa

Note: The dry pressure is based on a total pressure of 100 kPa and a water vapour pressure of 1 kPa.

Test atmospheric conditions:

- The atmospheric conditions during the test shall be the following:
- Temperature (T): Between 283 K and 313 K
- Pressure (P): Between 80 kPa and 110 kPa

Determination of correction factor:

(The tests may be carried out in air -conditioned tests rooms where the atmospheric conditions may be controlled.)

The power correction factor α for Positive Ignition Engines (Naturally aspirated or supercharged) obtained by applying the formula:

The correction Factor (α) is obtained by applying the formula:

$$\alpha = (99 / P_s)^{1.2} (T / 298)^{0.6}$$

Where,

Ps= the dry atmospheric pressure in kPa, that is the total barometric pressure minus water vapour pressure and

T= the absolute temperature in Kelvin (K) at the engine air inlet

The formula applies to carburetted engines and to other engines where the management system is designed to maintain relatively constant fuel / air ratio as ambient conditions change.

(The references for Power correction factor are taken from IS 14599:1999 clause 6.4.1)

- 6.0 The gross declared corrected power of the engine shall be measured on a test bench at rated speed of the engine. The measured power and speed may differ from the power and speed specified by the manufacturer as specified below:

Declared rated corrected gross Power & speed tolerance

➤ **For Constant speed engine**

(i) For Type Approval:

- For single cylinder engines, $\pm 5\%$ at the rated power point
- For all other engines, $\pm 4\%$ at the rated power point

(ii) For Conformity of Production:

- For single cylinder engines, at rated power point, $\pm 6\%$ of the type approved figure
- For all other engines, at rated power point, $\pm 5\%$ of the type approved figure

Declared rated Speed at rated power point shall vary within $\pm 1\%$

- 7.0 For verifying the conformity of production, for the selected engine, if the gross power and rated speed does not meet the limits, two additional engines for $>19\text{kW}$ or four in case $<19\text{kW}$ power rating category shall be tested for the rated gross power and rated speed.

The additional selected all engines shall meet the limits for the rated gross power and speed, out of these engines, one engine shall be subjected to the emission test for the conformance of production as mentioned in this part.

- 8.0 Single & two-cylinder engines shall be tested with the engine intake system. All the other engine shall be tested with either air intake system of applying maximum declared air intake depression of clean air intake

- 9.0 The engine shall be tested with the maximum exhaust back pressure values declared by the manufacturer. In case of the engines fitted with exhaust after treatment device and external EGR system, the manufacturer shall declare exhaust back pressure values at all five test points. The engine will be tested with the declared exhaust back pressure values set at laboratory condition with a tolerance of $\pm 10\%$ at rated load. At part load points the tolerance shall be as low as possible in the test laboratory conditions.

- 10.0 The no load speed or high idle speed and overload speed (correspondence to % overload power declared by manufacturer) shall be verified and documented against value specified by the manufacturer.

Appendix – 5

Crankcase Ventilation Requirements

The Regulation does not enforce a specific crankcase ventilation system for Genset engines. With option of Open and Close crankcase ventilation systems, verifying emissions of crankcase gases is required for engines with gross power >56 kW.

Crank case ventilation requirement shall be as per the guideline given in the ISO-8178-4: 2017, 2020 Reciprocating internal combustion engines — Exhaust emission measurement — Part 4: Steady-state and transient test cycles for different engine applications

Appendix – 6

Emission Durability Period (EDP), Deterioration Factor and Methodology for Adapting Emission Lab Test Results

1. Definitions

For the purposes of this appendix, the following definitions apply. Refer clause 2.1 for extensive set of definitions:

- 1.1. **“Ageing cycle”** means the engine operation (speed, load, power) to be executed during the service accumulation period.
- 1.2. **“Critical emission-related components”** means the exhaust after- treatment system, the electronic engine control unit and its associated sensors and actuators, and the EGR system including all related filters, coolers, control valves and tubing.
- 1.3. **“Critical emission-related maintenance”** means the maintenance to be performed on critical emission-related components of the engine.
- 1.4. **“Emission-related maintenance”** means the maintenance which substantially affects emissions or which is likely to affect emissions performance of the engine during normal in-use operation.
- 1.5. **“Engine-after-treatment system family”** means a manufacturer’s grouping of engines that comply with the definition of engine family, but which are further grouped into a family of engine families utilising a similar exhaust after-treatment system.
- 1.6. **“Non-emission-related maintenance”** means maintenance which does not substantially affect emissions and which does not have a lasting effect on the emissions performance deterioration of the engine during normal in-use operation once the maintenance is performed.
- 1.7. **“Service accumulation schedule”** means the ageing cycle and the service accumulation period for determining the deterioration factors for the engine-after-treatment system family.

2. General

- 2.1. This Appendix details the procedures for selecting engines to be tested over a service accumulation schedule for the purpose of determining deterioration factors for engine type approval and conformity of production assessments. The deterioration factors shall be applied to the emissions measured in accordance with Annex 4 and calculated in accordance with Annex 5 in accordance with the procedure set out in paragraph 3.2.7 of this appendix, respectively.
- 2.2. The service accumulation tests or the emissions tests performed to determine deterioration need not be witnessed by the Type Approval Authority.
- 2.3. This appendix also details the emission-related and non-emission-related maintenance that should be or may be carried out on engines undergoing a service accumulation schedule. Such maintenance shall conform to the maintenance performed on in-service engines and communicated to the end-users of new engines.

3. Engine categories Genset

- 3.1. Selection of engines for establishing emission durability period deterioration factors
 - 3.1.1. Engines shall be selected from the engine family defined in Clause 4.1 to establish emission durability period deterioration factors.
 - 3.1.2. Engines from different engine families may be further combined into families based on the type of exhaust after-treatment system utilised, or where no after-treatment is used, based upon the

similarity of the technical characteristics of the emission control system. Engines of different bore and stroke, different configuration, different air management systems, different fuel systems may be considered as equivalent in respect to emissions deterioration characteristics if the manufacturer provides data to the Type Approval Authority that there is a reasonable technical basis for such determination. In order to place engine families having similar technical specifications and installation for the exhaust after-treatment systems into the same engine after-treatment system family, the manufacturer shall provide data to the Type Approval Authority that demonstrates that the emissions reduction performance of such engines is similar.

- 3.1.3. The test engine shall represent the emission deterioration characteristics of the engine families that will apply the resulting deterioration factors for type approval. The engine manufacturer shall select one engine representing the engine family, group of engine families or engine-after-treatment system family, as determined in accordance with paragraph 3.1.2. of this Appendix, for testing over the service accumulation schedule referred to in paragraph 3.2.2. of this Appendix, which shall be reported to the Type Approval Authority before any testing commences.
- 3.1.4. If the Type Approval Authority decides that the worst-case emissions of the engine family, group of engine families or engine-after-treatment system family can be better characterised by another test engine, the test engine to be used shall be selected jointly by the Type Approval Authority and the engine manufacturer.

3.2. Determination of emission durability period deterioration factors

3.2.1. General

Deterioration factors applicable to an engine family, group of engine families or engine-after-treatment system family shall be developed from the selected engines based on a service accumulation schedule that includes periodic testing for gaseous emissions over each test cycle applicable to the engine category.

- 3.2.1.1. At the request of the manufacturer, the Type Approval Authority may allow the use of deterioration factors that have been established using alternative procedures to those specified in paragraphs 3.2.2. to 3.2.5. of this Appendix. In that case, the manufacturer shall demonstrate to the satisfaction of the Type Approval Authority that the alternative procedures used are not less rigorous than those set out in paragraphs 3.2.2. to 3.2.5. of this Annex.

3.2.2. Service accumulation schedule

Service accumulation schedules may be carried out at the choice of the manufacturer by running a Genset equipped with the selected engine over an "in-service" accumulation schedule or by running the selected engine over a "dynamometer service" accumulation schedule. The manufacturer shall not be required to use reference fuel for the service accumulation in-between emission measurement test points.

3.2.2.1. In-service and dynamometer service accumulation

- 3.2.2.1.1. The manufacturer shall determine the form and duration of the service accumulation and the ageing cycle for engines in a manner consistent with good engineering judgment.

- 3.2.2.1.2. The manufacturer shall determine the test points where gaseous emissions will be measured over the applicable cycles, as follows:

- 3.2.2.1.2.1. When running a service accumulation schedule shorter than the emission durability period in accordance with paragraph 3.2.2.1.7. of this Appendix, the minimum number of test points shall be three, one at the beginning, one approximately in the middle and one at the end of the service accumulation schedule.

- 3.2.2.1.2.2. When completing the service accumulation up to the end of the emission durability period, the minimum number of test points shall be two, one at the beginning and one at the end of the service accumulation.

- 3.2.2.1.2.3. The manufacturer may additionally test at evenly spaced intermediate points.

- 3.2.2.1.3. The emission values at the start point and at the emission durability period endpoint either calculated in accordance with paragraph 3.2.5.1. of this Appendix or measured directly in accordance with paragraph 3.2.2.1.2.2. of this Appendix, shall be within the limit values applicable to the engine family. However individual emission results from the intermediate test points may exceed those limit values.
- 3.2.2.1.4. Type Approval Authority to run only one test cycle) at each test point
- 3.2.2.1.5. Reserved
- 3.2.2.1.6. Service accumulation schedules may be different for different engine-after-treatment system families.
- 3.2.2.1.7. Service accumulation schedules may be shorter than the emission durability period, but shall not be shorter than the equivalent of at least one quarter of the relevant emission durability period as specified in below table

Emission durability period for Genset Engines > 19KW

Category (Power Band)	Emission durability period (hours)
>19 ≤ 56 kW (constant speed Engines)	3000
> 56 kW (All engines)	8000

- 3.2.2.1.8. Accelerated ageing by adjusting the service accumulation schedule on a fuel consumption basis is permitted. The adjustment shall be based on the ratio between the typical in-use fuel consumption and the fuel consumption on the ageing cycle, but fuel consumption on the ageing cycle shall not exceed typical in-use fuel consumption by more than 30 per cent.
- 3.2.2.1.9. At the request of the manufacturer and with the agreement of the Type Approval Authority, alternative methods of accelerated ageing may be permitted.
- 3.2.2.1.10. The service accumulation schedule shall be fully described in the application for type-approval and reported to the Type Approval Authority before the start of any testing.
- 3.2.2.2. If the Type Approval Authority decides that additional measurements need to be performed between the points selected by the manufacturer it shall notify the manufacturer. The revised service accumulation schedule shall be prepared by the manufacturer and agreed by the Type Approval Authority.

3.2.3. Engine testing

3.2.3.1. Engine stabilisation

- 3.2.3.1.1. For each engine-after-treatment system family, the manufacturer shall determine the number of hours of engine running (or a Genset application) after which the operation of the engine-after-treatment system has stabilised. If requested by the Type Approval Authority, the manufacturer shall make available the data and analysis used to make this determination. As an alternative, the manufacturer may run the engine or a Genset between 60 and 125 hours or the equivalent time on the ageing cycle to stabilise the engine-after-treatment system.
- 3.2.3.1.2. The end of the stabilisation period determined in paragraph 3.2.3.1.1. of this Appendix shall be deemed to be the start of the service accumulation schedule.

3.2.3.2. Service accumulation testing

- 3.2.3.2.1. After stabilisation, the engine shall be run over the service accumulation schedule selected by the manufacturer, as described in paragraph 3.2.2. of this Appendix. At the periodic intervals in the service accumulation schedule determined by the manufacturer, and, where applicable, decided by the Type Approval Authority in accordance with paragraph 3.2.2.2. of this Appendix, the engine shall be tested for gaseous and particulate emissions over steady state cycle as applicable to the engine category

The manufacturer may select to measure the pollutant emissions before any exhaust after-treatment system separately from the pollutant emissions after any exhaust after-treatment system.

In accordance with paragraph 3.2.2.1.4. of this Appendix, if it has been agreed that only one steady state test cycle (applicable 3-mode emission cycle) be run at each test point, at the beginning and at the end of the service accumulation schedule.

- 3.2.3.2.2. During the service accumulation schedule, maintenance shall be carried out on the engine in accordance with paragraph 3.4. of this Appendix.
- 3.2.3.2.3. During the service accumulation schedule, unscheduled maintenance on the engine may be performed, for example if the manufacturer's normal diagnostic system has detected a problem that would have indicated to genset operator that a fault had arisen.

3.2.4. Reporting

- 3.2.4.1. The results of all emission tests (applicable 3-mode emission cycle) conducted during the service accumulation schedule shall be made available to the Type Approval Authority. If an emission test is declared to be void, the manufacturer shall provide reasons why the test has been declared void. In such a case, another series of emission tests shall be carried out within the following 100 hours of service accumulation.
- 3.2.4.2. The manufacturer shall retain records of all information concerning all the emission tests and maintenance carried out on the engine during the service accumulation schedule. This information shall be submitted to the Type Approval Authority along with the results of the emission tests conducted over the service accumulation schedule.
- 3.2.5. Determination of deterioration factors
 - 3.2.5.1. When running a service accumulation schedule in accordance with paragraph 3.2.2.1.2.1. or paragraph 3.2.2.1.2.3. of this Appendix, for each pollutant measured over the applicable D1 – 3 mode emission cycle at each test point during the service accumulation schedule, a "best fit" linear regression analysis shall be made on the basis of all test results. The results of each test for each pollutant shall be expressed to the same number of decimal places as the limit value for that pollutant, as applicable to the engine family, plus one additional decimal place.

Where in accordance with paragraph 3.2.2.1.4. or paragraph 3.2.2.1.5. of this Appendix, only one steady state test cycle (applicable 3-mode emission cycle) has been run at each test point, the regression analysis shall be made only on the basis of the test results from the test cycle run at each test point.

The manufacturer may request the prior approval of the Type Approval Authority for a non-linear regression.

- 3.2.5.2. The emission values for each pollutant at the start of the service accumulation schedule and at the emission durability period end point that is applicable for the engine under test shall be either:
 - (a) determined by extrapolation of the regression equation in paragraph 3.2.5.1. of this Appendix, when running a service accumulation schedule in accordance with paragraph 3.2.2.1.2.1. or paragraph 3.2.2.1.2.3. of this Appendix, or
 - (b) measured directly, when running a service accumulation schedule in accordance with paragraph 3.2.2.1.2.2. of this Appendix.

Where emission values are used for engine families in the same engine-after-treatment family or group of engine families but with different emission durability periods, then the emission values at the emission durability period end point shall be recalculated for each emission durability period by extrapolation or interpolation of the regression equation as determined in paragraph 3.2.5.1. of this Appendix.

- 3.2.5.3. The deterioration factor (DF) for each pollutant is defined as the ratio of the applied emission values at the emission durability period end point and at the start of the service accumulation schedule (multiplicative deterioration factor).

The manufacturer may request the prior approval of the Type Approval Authority for the application of an additive DF for each pollutant may be applied. The additive DF is defined as the difference between the calculated emission values at the emission durability period end point and at the start of the service accumulation schedule.

An example for determination of DFs by using linear regression is shown in Figure A.8-1. for NOX emission.

Mixing of multiplicative and additive DFs within one set of pollutants is not permitted.

If the calculation results in a value of less than 1.00 for a multiplicative DF, or less than 0.00 for an additive DF, then the deterioration factor shall be 1.0 or 0.00, respectively.

In accordance with paragraph 3.2.2.1.4. of this Appendix, if it has been agreed that only one steady state test cycle (D1 – 3 Mode) be run at each test point

**Figure A.8-1.
Example of DF determination**

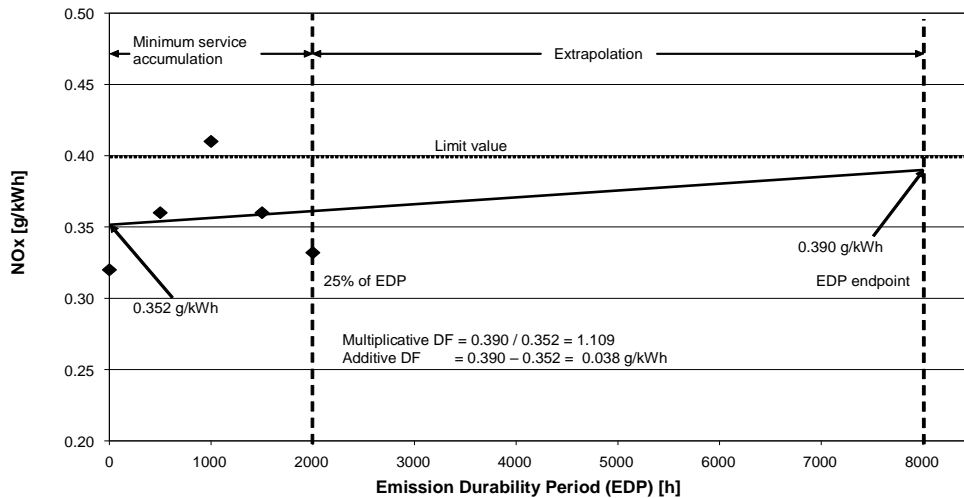

3.2.6. Assigned deterioration factors

3.2.6.1. As an alternative to using a service accumulation schedule to determine DFs, engine manufacturers may select to use assigned multiplicative DFs, as given in Table A.6-1.

Table A.6-1.

Assigned deterioration factors

Category (Power Band)	Deterioration Factors (DF)		
	CO	HC	NOx
>19 kW (Constant Speed Engine)	1.3	1.3	1.15

Note: When opted for assigned multiplicative DF, no verification is required.

Assigned additive DFs shall not be given. The assigned multiplicative DFs shall not be transformed into additive DFs.

3.2.6.2. Where assigned DFs are used, the manufacturer shall present to the Type Approval Authority robust evidence that the emission control components can reasonably be expected to have the emission durability associated with those assigned factors. This evidence may be based upon design analysis, or tests, or a combination of both.

3.2.7. Application of deterioration factors

3.2.7.1. The engines shall meet the respective emission limits for each pollutant, as applicable to the engine family, after application of the deterioration factors to the test result as measured in

accordance with Annex 5 (cycle-weighted specific emission for each individual gas). Depending on the type of DF, the following provisions apply:

- (a) Multiplicative: (cycle weighted specific emission) * DF ≤ emission limit
- (b) Additive: (cycle weighted specific emission) + DF ≤ emission limit

Cycle weighted specific emission may include the adjustment for infrequent regeneration, where applicable.

3.2.7.2. For a multiplicative NO_x + HC DF, separate HC and NO_x DFs shall be determined and applied separately when calculating the deteriorated emission levels from an emissions test result before combining the resultant deteriorated NO_x and HC values to establish compliance with the emission limit.

3.2.7.3. The manufacturer may carry across the DFs determined for an engine-after-treatment system family to an engine that does not fall into the same engine-after-treatment system family. In such cases, the manufacturer shall demonstrate to the Type Approval Authority that the engine for which the engine-after-treatment system family was originally tested and the engine for which the DFs are being carried across have similar technical specifications and installation requirements on the Genset and that the emissions of such engine are similar.

Where DFs are carried across to an engine with a different emission durability period, the DFs shall be recalculated for the applicable emission durability period by extrapolation or interpolation of the regression equation as determined in paragraph 3.2.5.1. of this Appendix.

3.2.7.4. The DF for each pollutant for each applicable test cycle shall be recorded in the test report set out in Annexure 2.

3.3. **Checking of conformity of production**

3.3.1. Conformity of production for emissions compliance is checked on the basis clause 5.

3.3.2. The manufacturer may measure the pollutant emissions before any exhaust after-treatment system at the same time as the type-approval test is being performed. For that purpose, the manufacturer may develop informal DFs separately for the engine without after-treatment system and for the after-treatment system that may be used by the manufacturer as an aid to end of production line auditing.

3.3.3. For the purposes of approval, only the DFs determined in accordance with paragraph 3.2.5. or 3.2.6. of this Appendix shall be recorded in the test report set out in Annexure 2.

3.4. **Maintenance**

For the purpose of the service accumulation schedule, maintenance shall be performed in accordance with the manufacturer's manual for service and maintenance.

3.4.1. Scheduled emission-related maintenance

3.4.1.1. Scheduled emission-related maintenance during engine running, undertaken for the purpose of conducting a service accumulation schedule, shall occur at equivalent intervals to those that are specified in the manufacturer's maintenance instructions to the end-user of the engine. This schedule maintenance may be updated as necessary throughout the service accumulation schedule provided that no maintenance operation is deleted from the maintenance schedule after the operation has been performed on the test engine.

3.4.1.2. Any adjustment, disassembly, cleaning, or exchange of critical emission-related components which is performed on a periodic basis within the emission durability period to prevent malfunction of the engine, shall only be done to the extent that is technologically necessary to ensure proper functioning of the emission control system. The need for scheduled exchange, within the service accumulation schedule and after a certain running time of the engine, of critical emission-related components other than those qualifying as routine exchange items shall be avoided. In this context, consumable maintenance items for regular renewal or items that require cleaning after a certain running time of the engine, shall qualify as routine exchange items.

3.4.1.3. Any scheduled maintenance requirements shall be subject to approval by the Type Approval Authority before type-approval is granted and shall be included in the customer's manual. The

Type Approval Authority shall not refuse to approve maintenance requirements that are reasonable and technically necessary, including but not limited to those identified in paragraph 3.4.1.4. of this Appendix.

3.4.1.4. The engine manufacturer shall specify for the service accumulation schedules any adjustment, cleaning, maintenance (where necessary) and scheduled exchange of the following items:

- filters and coolers in the exhaust gas re-circulation system
- positive crankcase ventilation valve, if applicable
- fuel injector tips (only cleaning is permitted)
- fuel injectors
- turbocharger
- electronic engine control unit and its associated sensors and actuators
- NO_x after-treatment system (including related components)
- exhaust gas re-circulation system, including all related control valves and tubing
- any other exhaust after-treatment system.

3.4.1.5. Scheduled critical emission-related maintenance shall only be performed if it is required to be performed in-use and that requirement is communicated to the end-user of the engine.

3.4.2. Changes to scheduled maintenance

The manufacturer shall submit a request to the Type Approval Authority for approval of any new scheduled maintenance that it wishes to perform during the service accumulation schedule and subsequently to recommend to end-users of engines. The request shall be accompanied by data supporting the need for the new scheduled maintenance and the maintenance interval.

3.4.3. Non-emission-related scheduled maintenance

Non-emission-related scheduled maintenance which is reasonable and technically necessary (for example oil change, oil filter change, fuel filter change, air filter change, cooling system maintenance, idle speed adjustment, governor, engine bolt torque, valve lash, injector lash, adjustment of the tension of any drive-belt, etc.) may be performed on engines selected for the service accumulation schedule at the least frequent intervals recommended by the manufacturer to the end-user (for example not at the intervals recommended for severe service).

3.5. Repair

3.5.1. Repairs to the components of an engine selected for testing over a service accumulation schedule shall be performed only as a result of component failure or engine malfunction. Repair of the engine itself, the emission control system or the fuel system is not permitted except to the extent defined in paragraph 3.5.2. of this Appendix.

3.5.2. If the engine, its emission control system (includes Oxidation catalyst, De-NO_x catalyst,) or its fuel system fails during the service accumulation schedule, the service accumulation shall be considered void, and a new service accumulation shall be started with a new engine.

The previous paragraph shall not apply when the failed components are replaced with equivalent components that have been subject to a similar number of hours of service accumulation.

Appendix – 7

Procedure for the Measurement & Calculation of Ammonia Emissions

3. **Ammonia measurement equipment** shall be as per the guideline given in the ISO-8178-1: 2017, 2020 Reciprocating internal combustion engines — Exhaust emission measurement — Part 1: Test-bed measurement systems of gaseous and particulate emission.
4. **Ammonia measurement procedure & calculation** shall be as per the guideline given in the ISO-8178-4: 2017, 2020 Reciprocating internal combustion engines — Exhaust emission measurement — Part 4: Steady-state and transient test cycles for different engine applications

Appendix – 8 Reserved

Appendix – 9 Reserved

ANNEXURE – 8

Requirements regarding emission control strategies, NO_x control measures

1. Definitions abbreviations and general requirements

1.1. For the purposes of this Annex, the following definitions and abbreviations apply:

- (a) "diagnostic trouble code ("DTC")" means a numeric or alphanumeric identifier which identifies or labels a NCM and/ PCM;
- (b) "confirmed and active DTC" means a DTC that is stored during the time the NCD system concludes that a malfunction exists;
- (c) "NCD engine family" "means a manufacturer's grouping of engines having common methods of monitoring/diagnosing NCMs
- (d) "NO_x Control Diagnostic system (NCD)" means a system on-board the engine/control room which has the capability of
 - (i) detecting a NO_x Control Malfunction,
 - (ii) identifying the likely cause of NO_x control malfunctions by means of information stored in computer memory and/or communicating that information off-board;
- (e) "NO_x Control Malfunction (NCM)" means an attempt to tamper with the NO_x control system of an engine or a malfunction affecting that system that might be due to tampering, that is considered by this Regulation as requiring the activation of a warning or an inducement system once detected;
 - (i) "Scan-tool" means an external test equipment used for off-board communication with the NCD system.

1.2. Ambient temperature

Where reference is made to ambient temperature in relation to environments other than a laboratory environment, the following provisions shall apply:

1.2.1 For an engine installed in a test-bed, ambient temperature shall be the temperature of the combustion air supplied to the engine, upstream of any part of the engine being tested.

1.2.2 For an engine installed in Genset, ambient temperature shall be the air temperature immediately outside the perimeter of the Genset. Manufacture may opt to consider temperature inside genset enclosure as an ambient temperature for certain diagnostics in consultation with type approval agency and using sound Engineering judgement.

2. Technical requirements relating to emission control strategies

2.1. This paragraph 2. shall apply for electronically controlled genset engines of all powered category complying with the emission limits set out in clause 3 of this Regulation and using electronic control to determine both the quantity and timing of injecting fuel or using electronic control to activate, de-activate or modulate the emission control system used to reduce NO_x.

2.2. Requirements for base emission control strategy

2.2.1 The base emission control strategy shall be designed as to enable the engine, in normal use, to comply with the provisions of this Regulation. Normal use is not restricted to the control conditions as specified in paragraph 2.4.

2.2.2. Base emission control strategies are, but not limited to, maps or algorithms for controlling:

- (a) timing of fuel injection or ignition (engine timing);

- (b) exhaust gas recirculation (EGR);
 - (c) SCR catalyst reagent dosing.
- 2.2.3. Any base emission control strategy that can distinguish engine operation between a standardised approval test and other operating conditions and subsequently reduce the level of emission control when not operating under conditions substantially included in the approval procedure is prohibited.
- 2.2.3.1. Reserved
- 2.2.4 The manufacturer shall demonstrate to the technical agency at the time of the type-approval test that the operation of the base emission control strategy complies with the provisions of this section. The demonstration shall consist of an evaluation of the documentation referred to in paragraph 2.6. of this Annex. The manufacturer shall comply with the documentation requirements laid down in paragraph 1.4. of Annex 1 and Appendix A.2 to that Annex.
- 2.3. Requirements for auxiliary emission control strategy.
- 2.3.1 An auxiliary emission control strategy may be activated by an engine or Genset, provided that the auxiliary emission control strategy:
- 2.3.1.1. does not permanently reduce the effectiveness of the emission control system;
 - 2.3.1.2. operates only outside the control conditions specified in paragraphs 2.4.3. of this Annex for the purposes defined in paragraph 2.3.5. of this Annex and only as long as is needed for those purposes, except as permitted by paragraphs 2.3.1.3., 2.3.2. and 2.3.4. of this Annex;
 - 2.3.1.3. is activated only exceptionally within the control conditions in paragraphs 2.4.3. of this Annex, respectively, has been demonstrated to be necessary for the purposes identified in paragraph 2.3.5. of this Annex has been approved by the Type Approval Authority, and is not activated for longer than is needed for those purposes;
 - 2.3.1.4. ensures a level of performance of the emission control system that is as close as possible to that provided by the base emission control strategy;
- 2.3.2. Where the auxiliary emission control strategy is activated during the type-approval test, activation shall not be limited to occur outside the control conditions set out in paragraph 2.4. of this Annex, and the purpose shall not be limited to the criteria set out in paragraph 2.3.5. of this Annex.
- 2.3.3. Where the auxiliary emission control strategy is not activated during the type-approval test, it must be demonstrated that the auxiliary emission control strategy is active only for as long as required for the purposes set out in paragraph 2.3.5. of this Annex.
- 2.3.4. Cold temperature operation.
- An auxiliary emission control strategy may be activated on an engine equipped with exhaust gas recirculation (EGR) irrespective of the control conditions in paragraph 2.4. of this Annex if the ambient temperature is below 275 K (2 °C) and one of the two following criteria is met:
- (a) intake manifold temperature is less than or equal to the temperature defined by the following equation: $IMT_c = P_{IM} / 15.75 + 304.4$, where: IMT_c is the calculated intake manifold temperature, K and P_{IM} is the absolute intake manifold pressure in kPa;
 - (b) engine coolant temperature is less than or equal to the temperature defined by the following equation: $ECT_c = P_{IM} / 14.004 + 325.8$, where: ECT_c is the calculated engine coolant temperature, K and P_{IM} is the absolute intake manifold pressure, kPa.
- 2.3.5. Except as permitted by paragraph 2.3.2. of this Annex, an auxiliary emission control strategy may solely be activated for the following purposes:
- (a) by on-board signals, for protecting the engine (including air-handling device protection) and/or Genset into which the engine is installed from damage;
 - (b) for operational safety reasons;

- (c) for prevention of excessive emissions, during cold start or warming-up, during shut-down;
 - (d) if used to trade-off the control of one regulated pollutant under specific ambient or operating conditions, for maintaining control of all other regulated pollutants, within the emission limit values that are appropriate for the engine concerned. The purpose is to compensate for naturally occurring phenomena in a manner that provides acceptable control of all emission constituents.
- 2.3.6. The manufacturer shall demonstrate to the technical agency at the time of the type-approval test that the operation of any auxiliary emission strategy complies with the provisions of this paragraph. The demonstration shall consist of an evaluation of the documentation referred to in paragraph 2.6. of this Annex.
- 2.3.7. Any operation of an auxiliary emission control strategy non-compliant with paragraphs 2.3.1. to 2.3.5. of this Annex is prohibited.

2.4. Control conditions

The control conditions specify an altitude, ambient temperature and engine coolant range that determines whether auxiliary emission control strategies may generally or only exceptionally be activated in accordance with paragraph 2.3. of this Annex.

The control conditions specify an atmospheric pressure which is measured as absolute atmospheric static pressure (wet or dry) ("Atmospheric pressure")

- 2.4.1. Reserved
- 2.4.2. Reserved

2.4.3. Control conditions for engines of power bands $56 \leq P < 800$ kW

- (a) the atmospheric pressure greater than or equal to 82,5 kPa;
- (b) the ambient temperature within the following range:
 - (i) equal to or above 273K (0 °C)
 - (ii) less than or equal to the temperature determined by the following equation at the specified atmospheric pressure: $T_c = -0.4514 \cdot (101.3 - P_b) + 311$, where: T_c is the calculated ambient air temperature, K and P_b is the atmospheric pressure, kPa; (With Ambient pressure P_b 100kPa, $T_c=38.58$ °C and P_b 82.5kPa, Altitude at 1700 meter /5500 feet, $T_c=46.5$ °C)
- (c) the engine coolant temperature above 343 K (70 °C).

Where the auxiliary emission control strategy is activated when the engine is operating within the control conditions set out in points (i), (ii) and (c), the strategy shall only be activated when demonstrated to be necessary for the purposes identified in clause 5.3.2.2.3. below and approved by the Test Agency.

- 2.5. Where the engine inlet air temperature sensor is being used to estimate ambient air temperature the nominal offset between the two measurement points shall be evaluated for an engine type or engine family. Where used, the measured intake air temperature shall be adjusted by an amount equal to the nominal offset to estimate ambient temperature for an installation using the specified engine type or engine family.

The evaluation of the offset shall be made using good engineering judgement based on technical elements (calculations, simulations, experimental results, data etc.) including:

- (a) the typical Genset enclosures into which the engine type or engine family will be installed; and,
- (b) the installation instructions provided to the OEM by the manufacturer.

A copy of the evaluation shall be made available to the Type Approval Authority upon request.

2.6. Documentation requirements

- 2.6.1 The manufacturer shall comply with the documentation requirements laid down in Annexure 1
- 2.6.2 The manufacturer shall ensure all documents used for this purpose are marked with an identification number and date. Whenever particulars recorded are changed the relevant pages shall be marked to clearly show the date of revision and the nature of the amendment. A consolidated, updated version, accompanied by a detailed description of the amendments, shall be deemed to fulfil the requirement of this paragraph. /Clause

3. Technical requirements relating to NO_x control measures

- 3.1. Clause 3. of this Annex shall apply to electronically controlled engines complying with the emission limits set out in clause 3 of this Regulation and using electronic control to determine both the quantity and timing of injecting fuel or using electronic control to activate, de-activate or modulate the emission control system used to reduce NO_x.
- 3.2. The manufacturer shall provide complete information on the functional operational characteristics of the NO_x control measures using the documents set out in Annexure 1.
- 3.3. The NO_x control strategy shall be operational under all environmental conditions regularly occurring in India especially at low ambient temperatures.
- 3.4. The manufacturer shall demonstrate that the emission of ammonia during the applicable emission test cycle of the type approval procedure, when a reagent is used, does not exceed a mean value of 10 ppm for >56 kW & 25 ppm for <56 kW engine categories.
- 3.5. For reagent containers installed on a genset/engine, means for taking a sample of the reagent inside the containers must be included. The sampling point must be easily accessible without requiring the use of any specialised tool or device.
- 3.6. In addition to the requirements set out in clauses 3.2. to 3.5. of this Annex, the technical requirements set out in Appendix A.1 of this Annex shall apply for engines.

4.0 Reserved

Appendix – A.1

Additional technical requirements on NO_x control measures for engines, including the method to demonstrate these strategies

A.1.1. Introduction

This Appendix sets out the additional requirements to ensure the correct operation of NO_x control measures. It includes requirements for engines that rely on the use of a reagent in order to reduce emissions. The type approval shall be made conditional upon the application of the relevant provisions on engine/genset operator or genset control room instruction, installation documents, operator warning system, inducement system and reagent freeze protection that are set out in this Appendix.

A.1.2. General requirements

The engine shall be equipped with a NO_x Control Diagnostic system (NCD) able to identify the NO_x control malfunctions (NCMs). Any engine covered by this paragraph shall be designed, constructed and installed so as to be capable of meeting these requirements throughout the normal life of the engine under normal conditions of use. In achieving this objective, it is acceptable that engines which have been used in excess of the emission durability period as specified in Appendix 6 to Annexure 7 of this Regulation show some deterioration in the performance and the sensitivity of the NO_x Control Diagnostic system (NCD), such that the thresholds specified in this Annexure may be exceeded before the warning and/or inducement systems are activated.

A.1.2.1. Required information

A.1.2.1.1. If the emission control system requires a reagent, the type of reagent, information on concentration when the reagent is in solution, its operational temperature conditions a reference to international standards for composition and quality and other characteristics of that reagent shall be specified by the manufacturer in accordance with Appendix A.3 of Annexure 1.

A.1.2.1.2. Detailed written information fully describing the functional operation characteristics of the engine or genset operator/genset control room warning system set out in paragraph A.1.4. of this Annexure and of the operator inducement system set out in paragraph A.1.5. of this Annexure shall be provided to the Type Approval Authority at the time of approval.

A.1.2.1.3. The manufacturer shall provide the OEM with documents with instructions on how to install the engine in the Genset in such manner that the engine, its emission control system and the Genset parts, operate in conformity with the requirements of this Appendix. This documentation shall include the detailed technical requirements of the engine (software, hardware, and communication) needed for the correct installation of the engine in the Genset application.

A.1.2.2. Operating conditions

A.1.2.2.1. Monitoring for reagent level in the storage tank shall be conducted under all conditions where measurement is technically feasible (for instance, under all conditions when a liquid reagent is not frozen).

A.1.2.2.2. Reagent freeze protection shall apply at ambient temperatures at or below 273K (0 °C).

A.1.2.2.3. All elements of the NO_x control diagnostic system other than those listed in paragraphs A.1.2.2.1. and A.1.2.2.2. of this Annexure shall, at a minimum be operational at the applicable control conditions set out in paragraph 2.4 of this Annexure for each engine category. The diagnostic system shall remain operational outside of this range where technically possible.

A.1.2.3. Reagent freeze protection

- A.1.2.3.1. It is permitted to use a heated or a non-heated reagent tank and dosing system. A heated system shall meet the requirements of paragraph A.1.2.3.2.2. of this Annexure. A non-heated system shall meet the requirements of paragraph A.1.2.3.2.3. of this Annexure.
- A.1.2.3.1.1. The use of a non-heated reagent tank and dosing system shall be indicated in the written instructions to the end-user of the Genset.
- A.1.2.3.2. Reagent tank and dosing system
- A.1.2.3.2.1. If the reagent has frozen, the reagent shall be available for use within a maximum of 70 minutes after the start of the engine at or above 273 K (0 °C) ambient temperature.
- A.1.2.3.2.2. Design criteria for a heated system
- A heated system shall be so designed that it meets the performance requirements set out in this paragraph A.1.2.3.2. when tested using the procedure defined.
- Demonstration test at the time of type approval is not mandatory.
- A.1.2.3.2.2.1. The reagent tank and dosing system shall be soaked at 255 K (- 18°C) for 72 hours or until the reagent becomes solid, whichever occurs first.
- A.1.2.3.2.2.2. After the soak period set out in paragraph A.1.2.3.2.2.1. of this Annexure, the Genset engine shall be started and operated at 266 K (- 7 °C) ambient temperature or lower as follows:
- (a) 10 to 20 minutes idling, followed by
- (b) up to 50 minutes at no more than 40 per cent of rated torque.
- A.1.2.3.2.2.3. At the conclusion of the test procedure set out in paragraph A.1.2.3.2.2.2. of this Annexure, the reagent dosing system shall be fully functional.
- A.1.2.3.2.2.4. Evaluation of the design criteria may be performed in a cold chamber test cell using an entire Genset or parts representative of those to be installed on such machinery or based on field tests.
- A.1.2.3.2.3. Activation of the operator warning and inducement system for a non-heated system
- A.1.2.3.2.3.1. The operator warning system described in paragraph A1.4 of this Annexure shall be activated if no reagent dosing occurs at an ambient temperature ≥ 273 K (0°C).
- A.1.2.3.2.3.2. The Operator inducement system described in paragraph A1.5. of this Annexure shall be activated if no reagent dosing occurs within a maximum of 70 minutes after engine start at an ambient temperature ≥ 273 K (0°C).
- A.1.2.4. Diagnostic requirements
- A.1.2.4.1. The NO_x Control Diagnostic system (NCD) shall be able to identify the NO_x control malfunctions (NCMs) by means of Diagnostic Trouble Codes (DTCs) stored in the computer memory and to communicate that information off-board upon request.
- A.1.2.4.2. Requirements for recording Diagnostic Trouble Codes (DTCs)
- A.1.2.4.2.1. The NCD system shall record a DTC for each distinct NO_x Control Malfunction (NCM).
- A.1.2.4.2.2. The NCD system shall conclude within 60 minutes of engine operation whether a detectable malfunction is present. At this time, a "confirmed and active" DTC shall be stored and the warning system be activated according to paragraph A.1.4. of this Annex.
- A.1.2.4.2.3. In cases where more than 60 minutes running time is required for the monitors to accurately detect and confirm a NCM (e.g. monitors using statistical models or with respect to fluid consumption on the Genset), the Type Approval Authority may permit a longer period for monitoring provided the manufacturer justifies the need for the longer period (for example by technical rationale, experimental results, in house experience, etc.).
- A.1.2.4.3. Requirements for erasing Diagnostic trouble codes (DTCs)

- (a) DTCs shall not be erased by the NCD system itself from the computer memory until the failure related to that DTC has been remedied.
- (b) The NCD system may erase all the DTCs upon request of a proprietary scan or maintenance tool that is provided by the engine manufacturer upon request, or using a pass code provided by the engine manufacturer.

A.1.2.4.4. An NCD system shall not be programmed or otherwise designed to deactivate partially or totally based on age of Genset during the actual life of the engine, nor shall the system contain any algorithm or strategy designed to reduce the effectiveness of the NCD system over time.

A.1.2.4.5. Any reprogrammable computer codes or operating parameters of the NCD system shall be resistant to tampering.

A.1.2.4.6. NCD engine family

The manufacturer is responsible for determining the composition of an NCD engine family. Grouping engines within an NCD engine family shall be based on good engineering judgment and be subject to approval by the Type Approval Authority.

Engines that do not belong to the same engine family may still belong to the same NCD engine family.

A.1.2.4.6.1. Parameters defining an NCD engine family

An NCD engine family is characterized by basic design parameters that shall be common to engines within the family.

In order that engines are considered to belong to the same NCD engine family, the following list of basic parameters shall be similar:

- (a) emission control systems;
- (b) methods of NCD monitoring;
- (c) criteria for NCD monitoring;
- (d) monitoring parameters (e.g. frequency).

These similarities shall be demonstrated by the manufacturer by means of relevant engineering demonstration or other appropriate procedures and subject to the approval of the Type Approval Authority.

The manufacturer may request approval by the Type Approval Authority of minor differences in the methods of monitoring/diagnosing the NCD system due to engine configuration variation, when these methods are considered similar by the manufacturer and they differ only in order to match specific characteristics of the components under consideration (for example size, exhaust gas flow, etc.); or their similarities are based on good engineering judgment.

A.1.3. Maintenance requirements

A.1.3.1. The OEM shall provide to all end-users of genset written instructions about the emission control system and its correct operation in accordance with Appendix 2 of Annexure 9.

A.1.4. Operator or control room warning system

A.1.4.1. The genset shall include an operator or control room warning system using visual and audible component that informs the operator when a low reagent level, incorrect reagent quality, interruption of dosing or a malfunction specified in clause A.1.9. of this Annexure has been detected that will lead to activation of the operator inducement system if not rectified in a timely manner. The warning system shall remain active when the operator inducement system described in paragraph A.1.5. of this Annexure has been activated.

- A.1.4.2. The warning shall not be the same as the warning used for the purposes of malfunction or other engine maintenance, though it may use the same warning system.
- A.1.4.3. The operator warning system may consist of one or more lamps, or display short messages, which may include, for example, messages indicating clearly:
- (a) the remaining time before activation of the low-level and / or severe inducements,
 - (b) the amount of low-level and / or severe inducement, for example the amount of torque reduction or effective disablement of operation.,
 - (c) the conditions under which Genset disablement can be cleared.
- Where messages are displayed, the system used for displaying these messages may be the same as the one used for other maintenance purposes.
- A.1.4.4. The warning system shall include an audible component to alert the operator in line with A.1.14 of this Annexure. The cancelling of audible warnings by the operator shall be permitted. An audible alarm system must be activated at minimum when the operator inducement system described in paragraph A.1.5. of this Annexure has been activated.
- A.1.4.5. The operator warning system shall be activated as specified in paragraphs A.1.2.3.2.3.1., A.1.6.2., A.1.7.2., A.1.8.3., and A.1.9.3. of this Annexure respectively.
- A.1.4.6. The operator warning system shall be deactivated when the conditions for its activation have ceased to exist. The operator warning system shall not be automatically deactivated without the reason for its activation having been remedied.
- A.1.4.7. The warning system may be temporarily interrupted by other warning signals providing important safety related messages.
- A.1.4.8. Details of the operator warning system activation and deactivation procedures are described in paragraph A.1.11. of this Annexure.
- A.1.4.9. As part of the application for approval under this Regulation, the manufacturer shall demonstrate the operation of the operator warning system, as specified in paragraph A.1.10. of this Annexure.

A.1.5. Operator inducement system

- A.1.5.1. The engine shall incorporate an operator inducement system based on one of the following principles:
- A.1.5.1.1. a two-stage inducement system starting with a low-level inducement Audio-Visual Alarm followed by a severe inducement (effective disablement of Genset operation);
 - A.1.5.1.2. a one-stage severe inducement system (effective disablement of Genset operation) activated under the conditions of a low-level inducement system as specified in paragraphs A.1.6.3.1., A.1.7.3.1., A.1.8.4.1., and A.1.9.4.1. of this Annexure.
- Where the manufacturer elects to shut down the engine to fulfil the requirement for one-stage severe inducement then the inducement for reagent level may, at the choice of the manufacturer, be activated under the conditions of paragraph A.1.6.3.2. of this Annexure instead of the conditions of paragraph A.1.6.3.1. of this Annexure.
- A.1.5.2. Reserved
- A.1.5.3. Low-level inducement system
- A.1.5.3.1. The low-level inducement system shall be activated after any of the conditions specified in paragraphs A.1.6.3.1., A.1.7.3.1., A.1.8.4.1., and A.1.9.4.1. of this Annexure has occurred.
 - A.1.5.3.2. Reserved
 - A.1.5.3.3. For constant speed engines, low level inducement shall the Audio-Visual Alarm
 - A.1.5.3.4. Other inducement measures that are demonstrated to the Type Approval Authority as having the same or greater level of severity may be used.

- A.1.5.4. Severe inducement system
- A.1.5.4.1. The severe inducement system shall be activated after any of the conditions specified in paragraphs A.1.2.3.2.3.2., A.1.6.3.2., A.1.7.3.2., A.1.8.4.2., and A.1.9.4.2. of this Annexure has occurred.
- A.1.5.4.2. The severe inducement system shall effectively disable Genset operation to cause the operator to remedy any problems related to paragraphs A.1.6. to A.1.9. of this Annexure. The following strategy shall be applied:
- (a) Strategy A:**
- An audio/visual warning and a grace period of 72 hours after which the severe inducement will effectively disable Genset operation to cause the operator to remedy any problems related to paragraphs A.1.6. to A.1.9. of this Annexure. (To mention no torque de-rate with this severe inducement strategy)
- (b) Strategy B:**
- An audio/visual warning with a torque de-rate of minimum 50% and a grace period of 120 hours after which the severe inducement will effectively disable Genset operation to cause the operator to remedy any problems related to paragraphs A.1.6. to A.1.9. of this Annexure.
- A.1.5.4.2.1. Genset engines, torque between the peak torque speed and the governor breakpoint shall be gradually reduce to zero torque and Minimum speed of 1 per cent per minute to zero percent of maximum torque within same time to speed reduction to Minimum speed within the same time as the torque reduction.
- Genset with severe-inducement condition activated when shut down; shall not start in next attempt barring activation of operator overrides described in paragraph A.1.5.5. of this annexure.
- A.1.5.4.2.2. Manufacturer may have option for direct disablement of engine after key off without going to torque / torque and speed de-rate schedule for severe level inducement as described in paragraph A.1.5.4.2.1 of this Annexure.
- A.1.5.4.2.3. Other inducement measures that are demonstrated to the Type Approval Authority as having the same or greater level of severity may be used.
- A.1.5.5. In order to account for safety concerns and to allow for self-healing diagnostics, use of an inducement override function for releasing full engine power is permitted provided it
- (a) is limited to 3 activations during each activation period that the operator inducement system is active and
- (b) each activation period is limited to 30 minutes
- A.1.5.6. The operator inducement system shall be deactivated when the conditions for its activation have ceased to exist. The operator inducement system shall not be automatically deactivated without the reason for its activation having been remedied.
- A.1.5.7. Details of the operator inducement system activation and deactivation procedures are described in paragraph A.1.11. of this Annexure.
- A.1.5.8. As part of the application for approval under this Regulation, the manufacturer shall demonstrate the operation of the operator inducement system, as specified in clause A.1.10. of this Annexure.
- A.1.6. Reagent Availability**
- A.1.6.1. Reagent level indicator
- The genset/engine shall include an indicator that clearly informs the operator /control room of the level of reagent in the reagent storage tank. The minimum acceptable performance level for the reagent indicator is that it shall continuously indicate the reagent level whilst the operator warning system referred to in paragraph A.1.4. of this Annexure is activated. The reagent indicator may be in the form of an analogue or

digital display, and may show the level as a proportion of the full tank capacity, the amount of remaining reagent, or the estimated operating hours remaining

Additionally, remote information and monitoring system described in Appendix 4 of this Annexure where applicable shall provide with reagent level information at least when operator warning system referred to in paragraph A.1.4. of this Annexure is activated.

- A.1.6.2. Activation of the operator warning system
 - A.1.6.2.1. The operator warning system specified in paragraph A.1.4. of this Annexure shall be activated when the level of reagent goes below 10 per cent of the capacity of the reagent tank or a higher percentage at the choice of the manufacturer.
 - A.1.6.2.2. The warning provided shall be sufficiently clear, in conjunction with the reagent indicator, for the operator to understand that the reagent level is low. When the warning system includes a message display system, the visual warning shall display a message indicating a low level of reagent. (for example, "urea level low", "AdBlue level low", or "reagent low").
 - A.1.6.2.3. The operator warning system does not initially need to be continuously activated (for example a message does not need to be continuously displayed), however activation shall escalate in intensity so that it becomes continuous as the level of the reagent approaches empty and the point where the operator inducement system will come into effect is approached (for example frequency at which a lamp flashes). It shall culminate in an operator notification at a level that is at the choice of the manufacturer, but sufficiently more noticeable at the point where the operator inducement system in paragraph A.1.6.3. of this Annexure comes into effect than when it was first activated.
 - A.1.6.2.4. The continuous warning shall not be easily disabled or ignored. When the warning system includes a message display system, an explicit message shall be displayed (for example "fill up urea", "fill up AdBlue", or "fill up reagent"). The continuous warning may be temporarily interrupted by other warning signals providing important safety related messages.
 - A.1.6.2.5. It shall not be possible to turn off the operating warning system until the reagent has been replenished to a level not requiring its activation.
 - A.1.6.2.6. Additionally, audio warning system described in paragraph A.1.14 of this Annexure shall become active when the level of reagent goes below 10 per cent of the capacity of the reagent tank or at a percentage operator warning system is activated at the choice of the manufacturer.
- A.1.6.3 Activation of the operator inducement system
 - A.1.6.3.1 The low-level inducement system described in paragraph A.1.5.3. of this Annexure shall be activated if the reagent tank level goes below 2.5 per cent of its nominally full capacity or a higher percentage at the choice of the manufacturer.
 - A.1.6.3.2. The severe inducement system described in paragraph A.1.5.4. of this Annexure shall be activated if the reagent tank is empty, that is, when the dosing system is unable to draw further reagent from the tank, or at any level below 2.5 per cent of its nominally full capacity at the discretion of the manufacturer.
 - A.1.6.3.3. Except to the extent permitted by paragraph A.1.5.5. of this Annexure, it shall not be possible to turn off the low-level or severe inducement system until the reagent has been replenished to a level not requiring their respective activation.

A.1.7. Reagent Quality Monitoring

- A.1.7.1. The engine, or Genset shall include a means of determining the presence of an incorrect reagent on board.
 - A.1.7.1.1. The manufacturer shall specify a minimum acceptable reagent concentration CD_{min} , which results in tailpipe NO_x emissions not exceeding the lower of either the applicable NO_x limit multiplied by 2.25 or the applicable NO_x limit plus 1.5 g/kWh. For engine sub-categories with a combined HC and NO_x limit, the applicable NO_x limit value for the

purpose of this paragraph shall be the combined limit value for HC and NO_x reduced by 0.19 g/kWh.

- A.1.7.1.1.1. The value of CD_{min} specified by the manufacturer shall be used during the demonstration set out in paragraph A.1.13. of this Annexure and recorded in the extended documentation package as specified in Appendix A.3 to Annex 1.
- A.1.7.1.2. Any reagent concentration lower than CD_{min} shall be detected and be regarded, for the purpose of paragraph A.1.7.1. of this Annexure, as being incorrect reagent.
- A.1.7.1.3. A specific counter ("the reagent quality counter") shall be attributed to the reagent quality. The reagent quality counter shall count the number of engine operating hours with an incorrect reagent.
- A.1.7.1.3.1. Optionally, the manufacturer may group the reagent quality failure together with one or more of the failures listed in paragraphs A.1.8. of this Annexure and A.1.9. of this Annexure into a single counter.
- A.1.7.1.4. Details of the reagent quality counter activation and deactivation criteria and mechanisms are described in paragraph A.1.11. of this Annexure.
- A.1.7.2. Activation of the operator warning system

When the monitoring system confirms that the reagent quality is incorrect, the operator warning system described in paragraph 1.4 shall be activated. When the warning system includes a message display system, it shall display a message indicating the reason of the warning (for example "incorrect urea detected", "incorrect AdBlue detected", or "incorrect reagent detected").
- A.1.7.3 Activation of the operator inducement system
- A.1.7.3.1. The low-level inducement system described in paragraph A.1.5.3. of this Annexure shall be activated if the reagent quality is not rectified within a maximum of 36 engine operating hours after the activation of the operator warning system as described in paragraph A.1.7.2. of this Annexure.
- A.1.7.3.2. The severe inducement system described in paragraph A.1.5.4. of this Annexure shall be activated if their emission performance does not require reagent dosing. The severe inducement system described in clause A.1.5.4. of this Appendix shall be activated if the reagent quality is not rectified within a maximum of 72 engine operating hours after the activation of the operator warning system as described in clause A.1.7.2. of this Appendix.
- A.1.7.3.3. The number of hours prior to activation of the inducement systems shall be reduced in case of a repetitive occurrence of the malfunction according to the mechanism described in clause A.1.11. of this Appendix.
- A.1.8. Reagent Dosing Activity
- A.1.8.1 The engine shall include a means of determining interruption of dosing.
- A.1.8.2. Reagent dosing activity counter
- A.1.8.2.1. A specific counter shall be attributed to the dosing activity (the "dosing activity counter"). The counter shall count the number of engine operating hours which occur with an interruption of the reagent dosing activity. This is not required where such interruption is demanded by the engine ECU because the Genset operating conditions are such that their emission performance does not required reagent dosing.
- A.1.8.2.1.1. Optionally, the manufacturer may group the reagent dosing failure together with one or more of the failures listed in paragraphs A.1.7. and A.1.9. of this Annexure into a single counter.
- A.1.8.2.2. Details of the reagent dosing activity counter activation and deactivation criteria and mechanisms are described in paragraph A.1.11. of this Annexure.
- A.1.8.3. Activation of the operator warning system

The operator warning system described in paragraph A.1.4. of this Annexure shall be activated in the case of interruption of dosing which sets the dosing activity counter in accordance with paragraph A.1.8.2.1. of this Annexure. When the warning system includes a message display system, it shall display a message indicating the reason of the warning (e.g. "urea dosing malfunction", "AdBlue dosing malfunction", or "reagent dosing malfunction").

A.1.8.4. Activation of the operator inducement system

A.1.8.4.1. The low-level inducement system described in paragraph A.1.5.3. of this Annexure shall be activated if an interruption in reagent dosing is not rectified within a maximum of 36 engine operating hours after the activation of the operator warning system in accordance with paragraph A.1.8.3. of this Annexure.

A.1.8.4.2. The severe inducement system described in paragraph A.1.5.4. of this Annexure shall be activated if an interruption in reagent dosing is not rectified within a maximum of **72** engine operating hours after the activation of the operator warning system in accordance with paragraph A.1.8.3. of this Annexure.

A.1.8.4.3. The number of hours prior to activation of the inducement systems shall be reduced in case of a repetitive occurrence of the malfunction according to the mechanism described in paragraph A.1.11. of this Annexure.

A.1.9. Other failures that may be attributed to tampering

A.1.9.1. In addition to the level of reagent in the reagent tank, the reagent quality, and the interruption of dosing, the following failures shall be monitored because they may be attributed to tampering:

(a) failures of the NO_x Control Diagnostic (NCD) system as described in paragraph A.1.9.2.1. of this Annexure;

(b) failures of the exhaust gas recirculation (EGR) valve as described in paragraph A.1.9.2.2. of this Annexure;

A.1.9.2. Monitoring requirements and counters

A.1.9.2.1. NCD system

A.1.9.2.1.1. The NO_x Control Diagnostic (NCD) system shall be monitored for electrical failures and for removal or deactivation of any sensor that prevents it from diagnosing any other failures set out in paragraphs A.1.6. to A.1.8. (component monitoring) of this Annexure.

A non-exhaustive list of sensors that affect the diagnostic capability are those directly measuring NO_x concentration, urea quality sensors, ambient sensors and sensors used for monitoring reagent dosing activity, reagent level or reagent consumption.

A.1.9.2.1.2. A counter shall be attributed to each of the monitoring failures. The NCD system counters shall count the number of engine operating hours when the DTC associated to a malfunction of the NCD system is confirmed to be active. Different NCD system failures may be grouped into a single counter.

A.1.9.2.1.2.1. The manufacturer may group the NCD system failure together with one or more of the failures listed in paragraphs A.1.7., A.1.8. and paragraph A.1.9.2.2 of this Annexure into a single counter.

A.1.9.2.1.3. Details of the NCD system counter(s) activation and deactivation criteria and mechanisms are described in paragraph A.1.11. of this Annexure.

A.1.9.2.2. EGR valve

A.1.9.2.2.1. The EGR system shall be monitored for an impeded EGR valve.

A.1.9.2.2.2. A counter shall be attributed to an impeded EGR valve. The EGR valve counter shall count the number of engine operating hours when the DTC associated to an impeded EGR valve is confirmed to be active.

- A.1.9.2.2.2.1. The manufacturer may group the impeded EGR valve failure together with one or more of the failures listed in paragraphs A.1.7., A.1.8. and A.1.9.2.1 of this Annexure. into a single counter.
- A.1.9.2.2.3. Details of the EGR valve counter activation and deactivation criteria and mechanisms are described in paragraph A.1.11. of this Annexure.
- A.1.9.3. Activation of the operator warning system

The operator warning system set out in paragraph 1.4. shall be activated in case any of the failures specified in paragraph A.1.9.1. of this Annexure occur, and shall indicate that an urgent repair is required. When the warning system includes a message display system, it shall display a message indicating either the reason of the warning (for example "reagent dosing valve disconnected", or "critical emission failure").
- A.1.9.4. Activation of the operator inducement system
 - A.1.9.4.1. The low-level inducement system described in paragraph A.1.5.3. of this Annexure shall be activated if a failure specified in paragraph A.1.9.1. of this Annexure is not rectified within a maximum of **36** engine operating hours after the activation of the operator warning system set out in paragraph A.1.9.3. of this Annexure.
 - A.1.9.4.2. The severe inducement system described in paragraph A.1.5.4. of this Annexure shall be activated if a failure specified in paragraph A.1.9.1. of this Annexure is not rectified within a maximum of **72** engine operating hours after the activation of the operator warning system set out in paragraph A.1.9.3. of this Annexure.
 - A.1.9.4.3. The number of hours prior to activation of the inducement systems shall be reduced in case of a repetitive occurrence of the malfunction according to the mechanism described in paragraph A.1.11. of this Annexure.
 - A.1.9.5. As an alternative to the monitoring requirements set out in paragraph A.1.9.2. of this Annexure, the manufacturer may monitor for failures using a NO_x sensor located in the exhaust system. In this case,
 - (a) the NO_x value at which the NCM shall be detected shall not exceed the lower of either the applicable NO_x limit multiplied by 2.25 or the applicable NO_x limit plus 1.5 g/kWh. For engine sub-categories with a combined HC and NO_x limit, the applicable NO_x limit value for the purpose of this paragraph shall be the combined limit value for HC and NO_x reduced by 0.19 g/kWh.
 - (b) a single warning may be used, including, where messages are used, the statement 'high NO_x – root cause unknown',
 - (c) in paragraph A.1.9.4.1. of this Annexure the maximum number of engine operating hours between the activation of the operator warning system and the activation of the low-level inducement system shall be 36 hours
 - (d) in paragraph A.1.9.4.2. of this Annexure the maximum number of engine operating hours between the activation of the operator warning system and the activation of the severe inducement system shall be 72 hours

A.1.10. Demonstration requirements

- A.1.10.1. General

The compliance to the requirements of this Appendix shall be demonstrated during type-approval by performing, as illustrated in Table A.8-1. and specified in paragraph A.1.10. of this Annexure:

 - (a) a demonstration of the warning system activation
 - (b) a demonstration of the low-level inducement system activation, if applicable
 - (c) a demonstration of the severe inducement system activation
- A.1.10.2. Engine families and NCD engine families

The compliance of an engine family or an NCD engine family with the requirements of paragraph A.1.10. of this Annexure may be demonstrated by testing one of the

members of the considered family, provided the manufacturer demonstrates to the Type Approval Authority that the monitoring systems necessary for complying with the requirements of this Appendix are similar within the family.

- A.1.10.2.1. The demonstration that the monitoring systems for other members of the NCD engine family are similar may be performed by presenting to the approval authorities such elements as algorithms, functional analyses, etc.
- A.1.10.2.2. The test engine is selected by the manufacturer in agreement with the Type Approval Authority. It may or may not be the parent engine of the considered family.
- A.1.10.2.3. In the case where engines of an engine family belong to an NCD engine family that has already been type-approved, according to paragraph A.1.10.2.1. (Figure A.8-3.) of this Annexure the compliance of that engine family is deemed to be demonstrated without further testing, provided the manufacturer demonstrates to the authority that the monitoring systems necessary for complying with the requirements of this Appendix are similar within the considered engine and NCD engine families.

Table A.8-1.

Illustration of the content of the demonstration process in accordance with the provisions in paragraphs A.1.10.3. and A.1.10.4.

Mechanism	Demonstration elements
Warning system activation specified in paragraph A.1.10.3. of this Annexure	2 activation tests (incl. lack of reagent) Supplementary demonstration elements, as appropriate
Low-level inducement activation specified in paragraph A.1.10.4. of this Annexure	2 activation tests (incl. lack of reagent) - Supplementary demonstration elements, as appropriate 1 The Audio-Visual Alarm
Severe inducement activation specified in paragraph A.1.10.4. of this Annexure	2 activation tests (incl. lack of reagent) - Supplementary demonstration elements, as appropriate

Figure A.8-3.

Previously demonstrated conformity of an NCD engine family

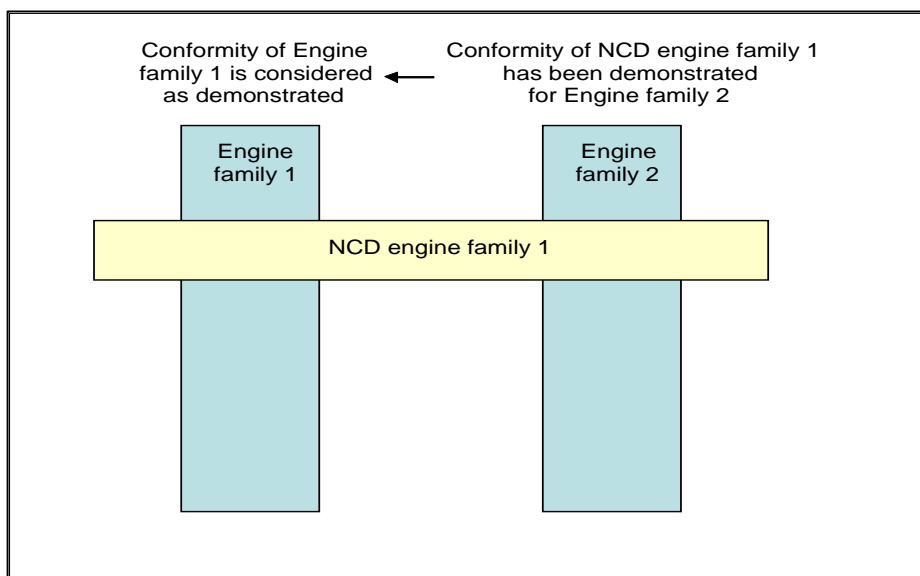

- A.1.10.3. Demonstration of the warning system activation

- A.1.10.3.1. The compliance of the warning system activation shall be demonstrated by performing two tests: lack of reagent, and one failure category identified in paragraphs A.1.7, A.1.8. or A.1.9. of this Annexure.
- A.1.10.3.2. Selection of the failure to be tested from paragraphs A.1.7., A.1.8., or A.1.9. of this Annexure.
 - A.1.10.3.2.1. The Type Approval Authority shall select one failure category. In the case that a failure is selected from points A.1.7. or A.1.9. of this Annexure the additional requirements set out in points A.1.10.3.2.2. or A.1.10.3.2.3. of this Annexure respectively shall apply.
 - A.1.10.3.2.2 For the purpose of demonstrating the activation of the warning system in case of a wrong reagent quality, a reagent shall be selected with a dilution of the active ingredient at least as dilute as that communicated by the manufacturer according to the requirements set out in paragraph A.1.7. of this Annexure.
 - A.1.10.3.2.3. For the purpose of demonstrating the activation of the warning system in case of failures that may be attributed to tampering, and are defined in paragraph A.1.9. of this Annexure the selection shall be performed according to the following requirements:
 - A.1.10.3.2.3.1. The manufacturer shall provide the Type Approval Authority with a list of such potential failures.
 - A.1.10.3.2.3.2. The failure to be considered in the test shall be selected by the Type Approval Authority from this list referred to in paragraph A.1.10.3.2.3.1. of this Annexure.
- A.1.10.3.3. Demonstration
 - A.1.10.3.3.1. For the purpose of this demonstration, a separate test shall be performed for the lack of reagent and the failure selected in paragraph A.1.10.3.2. of this Annexure.
 - A.1.10.3.3.2. During a test, no failure shall be present other than the one addressed by the test.
 - A.1.10.3.3.3. Prior to starting a test, all DTC shall have been erased.
 - A.1.10.3.3.4. At the request of the manufacturer, and with the agreement of the Type Approval Authority, the failures subject to testing may be simulated.
 - A.1.10.3.3.5. Detection of failures other than lack of reagent.

For failures other than lack of reagent, once the failure installed or simulated, the detection of that failure shall be performed as follows:

 - A.1.10.3.3.5.1. The NCD system shall respond to the introduction of a failure selected as appropriate by the Type Approval Authority in accordance to the provisions of this Appendix. This is demonstrated if activation occurs within two consecutive NCD test-cycles according to paragraph A.1.10.3.3.7. of this Annexure.

When it has been specified in the monitoring description and agreed by the Type Approval Authority that a specific monitor needs more than two NCD test-cycles to complete its monitoring, the number of NCD test-cycles may be increased to 3 NCD test-cycles.

Each individual NCD test-cycle in the demonstration test may be separated by an engine shut-off. The time until the next start-up shall take into consideration any monitoring that may occur after engine shut-off and any necessary condition that must exist for monitoring to occur at the next start up.
 - A.1.10.3.3.5.2 The demonstration of the warning system activation is deemed to be accomplished if, at the end of each demonstration test performed according to paragraph A.1.10.3.3. of this Annexure, the warning system has been properly activated and the DTC for the selected failure has got the “confirmed and active” status.
 - A.1.10.3.3.6. Detection in case of lack of reagent availability

For the purpose of demonstrating the activation of the warning system in case of lack of reagent availability, the engine shall be operated over one or more NCD test cycles at the discretion of the manufacturer.

- A.1.10.3.3.6.1. The demonstration shall start with a level of reagent in the tank to be agreed between the manufacturer and the Type Approval Authority but representing not less than 10 per cent of the nominal capacity of the tank.
- A.1.10.3.3.6.2. The warning system is deemed to have performed in the correct manner if the following conditions are met simultaneously:
- (a) the warning system has been activated with a reagent availability **greater** or equal to 10 per cent of the capacity of the reagent tank
 - (b) the "continuous" warning system has been activated with a reagent availability greater or equal to the value declared by the manufacturer in accordance with the provisions of paragraph A.1.6. of this Annexure.
- A.1.10.3.3.7. NCD test cycle
- A.1.10.3.3.7.1 The NCD test cycle considered in clause A.1.10. of this Annexure for demonstrating the correct performance of the NCD system is the D1- 3 Mode cycle for constant speed engine
- A.1.10.3.3.7.2 On request of the manufacturer with approval of the test agency, an alternative NCD Cycle (e.g. other than D1-3 Mode cycle) can be used for specific monitoring
- A.1.10.3.4. The demonstration of the warning system activation is deemed to be accomplished if, at the end of each demonstration test performed according to paragraph A.1.10.3.3. of this Annexure, the warning system has been properly activated.
- A.1.10.4. Demonstration of the inducement system
- A.1.10.4.1. The demonstration of the inducement system shall be done by tests performed on an engine test bench.
- A.1.10.4.1.1. Any components or sub-systems not physically mounted on the engine, such as, but not limited to, ambient temperature sensors, level sensors, and operator warning and information systems, that are required in order to perform the demonstrations shall be connected to the engine for that purpose, or shall be simulated, to the satisfaction of the Type Approval Authority.
- A.1.10.4.1.2. If the manufacturer chooses, and subject to the agreement of the Type Approval Authority, the demonstration tests may be performed on a complete Genset either by mounting the same on a suitable test bed or, notwithstanding paragraph A.1.10.4.1. of this Annexure, by running it outside test laboratory under controlled conditions.
- A.1.10.4.2. The test sequence shall demonstrate the activation of the inducement system in case of lack of reagent and in case of the failure selected by the Approval Authority according to paragraph A.1.10.3.2.1. of this Annexure for the test of the warning system.
- A.1.10.4.3. For the purpose of this demonstration,
- (a) the manufacturer shall, in agreement with the Type Approval Authority, be permitted to accelerate the test by simulating the achievement of a certain number of operating hours,
 - (b) Reserved
 - (c) the low-level inducement, if applicable, shall be demonstrated according to the requirements of paragraph A.1.10.4.5. of this Annexure.
 - (d) the severe inducement shall be demonstrated according to the requirements of paragraph A.1.10.4.6. of this Annexure.
- A.1.10.4.4. The manufacturer shall, in addition, demonstrate the operation of the inducement system under those failure conditions defined in paragraphs A.1.7., A.1.8. or A.1.9. of this Annexure which have not been chosen for use in demonstration tests described in paragraphs A.1.10.4.1. to A.1.10.4.3. of this Annexure.
- These additional demonstrations may be performed by presentation to the Type Approval Authority of a technical case using evidence such as algorithms, functional analyses, and the result of previous tests.

- A.1.10.4.4.1. These additional demonstrations shall demonstrate to the satisfaction of the Type Approval Authority the inclusion of the correct torque reduction mechanism in the engine ECU.
- A.1.10.4.5. Demonstration test of the low-level inducement system
- A.1.10.4.5.1. This demonstration starts when the warning system or when appropriate "continuous" warning system has been activated as a result of the detection of a failure selected by the Type Approval Authority.
- A.1.10.4.5.2. When the system is being checked for its reaction to the case of lack of reagent in the tank, the engine shall be run until the reagent availability has reached a value of 2.5 per cent of the tank nominal full capacity of the tank or the value declared by the manufacturer in accordance with paragraph A.1.6.3.1. of this Annexure at which the low-level inducement system is intended to operate.
- A.1.10.4.5.2.1. The manufacturer may, with the agreement of the Type Approval Authority, simulate continuous running by extracting reagent from the tank, either whilst the engine is running or is stopped.
- A.1.10.4.5.3. When the system is checked for its reaction in the case of a failure other than a lack of reagent in the tank, the engine shall be run for the relevant number of operating hours indicated in Table A.8-4. or, at the choice of the manufacturer, until the relevant counter has reached the value at which the low-level inducement system is activated.
- A.1.10.4.5.4. The demonstration of the low-level inducement system shall be deemed to be accomplished if, at the end of each demonstration test performed according to paragraphs A.1.10.4.5.2. and A.1.10.4.5.3. of this Annexure, the manufacturer has demonstrated to the Type Approval Authority that the engine ECU has activated the Audio-Visual Alarm or torque reduction mechanism.
- A.1.10.4.6. Demonstration test of the severe inducement system
- A.1.10.4.6.1. This demonstration shall start from a condition where the low-level inducement system, where applicable, has been previously activated and may be performed as a continuation of the tests undertaken to demonstrate the low-level inducement system.
- A.1.10.4.6.2. When the system is checked for its reaction in the case of lack of reagent in the tank, the engine shall be run until the reagent tank is empty, or has reached the level below 2.5 per cent of nominal full capacity of the tank at which the manufacturer has declared to activate the severe inducement system.
- A.1.10.4.6.2.1. The manufacturer may, with the agreement of the Type Approval Authority, simulate continuous running by extracting reagent from the tank, either whilst the engine is running or is stopped.
- A.1.10.4.6.3. When the system is checked for its reaction in the case of a failure that is not a lack of reagent in the tank, the engine shall then be run for the relevant number of operating hours indicated in Table A.8-4. or, at the choice of the manufacturer, until the relevant counter has reached the value at which the severe inducement system is activated.
- A.1.10.4.6.4. The demonstration of the severe inducement system shall be deemed to be accomplished if, at the end of each demonstration test performed according to paragraphs A.1.10.4.6.2. and A.1.10.4.6.3. of this Annexure, the manufacturer has demonstrated to the Type Approval Authority that the severe inducement mechanism considered in this Appendix has been activated.
- A.1.10.4.7. Alternatively, if the manufacturer chooses, and subject to the agreement of the Type Approval Authority, the demonstration of the inducement mechanisms may be performed on a complete Genset in accordance with the requirements of paragraphs A.1.5.4. and A.1.10.4.1.2. of this Annexure, either by mounting the Genset on a suitable test bed or by running it outside test laboratory under controlled conditions.
- A.1.10.4.7.1. The Genset shall be operated until the counter associated with the selected failure has reached the relevant number of operating hours indicated in Table A.8-4. or, as appropriate, until either the reagent tank is empty or, has reached the level below 2.5

per cent of nominal full capacity of the tank at which the manufacturer has chosen to activate the severe inducement system.

A.1.10.5. Documentation of the demonstration

A.1.10.5.1 A demonstration report shall be created that documents the demonstration of the NCD system.

The report shall:

- (a) identify the failures examined;
- (b) describe the demonstration performed including the applicable test cycle;
- (c) confirm that the applicable warnings and inducements were activated as required by this regulation;
- (d) be included in the information folder as set out in Annexure 1.

A.1.11. Description of the operator warning and inducement activation and deactivation mechanisms

A.1.11.1 To complement the requirements specified in this Appendix concerning the warning and inducement activation and deactivation mechanisms, paragraph A.1.11. of this Annexure specifies the technical requirements for an implementation of those activation and deactivation mechanisms.

A.1.11.2. Activation and deactivation mechanisms of the warning system

A.1.11.2.1. The operator warning system shall be activated when the diagnostic trouble code (DTC) associated with a NCM justifying its activation has the status defined in Table A.8-2.

**Table A.8-2
Activation of the operator warning system**

Failure type	DTC status for activation of the warning system
Poor reagent quality	confirmed and active
Interruption of dosing	confirmed and active
Impeded EGR valve	confirmed and active
Malfunction of the monitoring system	confirmed and active
NO _x threshold, if applicable	confirmed and active

A.1.11.2.2. The operator warning system shall be deactivated when the diagnosis system concludes that the malfunction relevant to that warning is no longer present or when the information including DTCs relative to the failures justifying its activation is erased by a scan tool.

A.1.11.2.2.1. Requirements for erasing " NO_x control information"

A.1.11.2.2.1.1. Erasing / resetting " NO_x control information" by a scan-tool

On request of the scan tool, the following data shall be erased or reset to the value specified in this Appendix from the computer memory (see Table A.8-3.).

**Table A.8-3.
Erasing / resetting "NO_x control information" by a scan-tool**

NO_x control information	Erasable	Resettable

All DTCs	X	
The value of the counter with the highest number of engine operating hours		X
The number of engine operating hours from the NCD counter(s)		X

- A.1.11.2.2.1.2. NO_x control information shall not be erased by disconnection of the battery(ies) of the Genset.
- A.1.11.2.2.1.3. The erasing of " NO_x control information" shall only be possible under "engine-off" conditions.
- A.1.11.2.2.1.4. When "NO_x control information" including DTCs are erased, any counter associated with these failures and which is specified in this Appendix shall not be erased, but reset to the value specified in the appropriate paragraph of this Appendix.
- A.1.11.3. Activation and deactivation mechanism of the operator inducement system
- A.1.11.3.1. The operator inducement system shall be activated when the warning system is active and the counter relevant to the type of NCM justifying their activation have reached the value specified in Table A.8-4
- A.1.11.3.2. The operator inducement system shall be deactivated when the system no longer detects a malfunction justifying its activation, or if the information including the DTCs relative to the NCMs justifying its activation has been erased by a scan tool or maintenance tool.
- A.1.11.3.3. The operator warning and inducement systems shall be immediately activated or deactivated as appropriate according to the provisions of paragraph A.1.6. of this Annexure after assessment of the reagent quantity in the reagent tank. In that case, the activation or deactivation mechanisms shall not depend upon the status of any associated DTC.
- A.1.11.4. Counter mechanism
- A.1.11.4.1. General
- A.1.11.4.1.1. To comply with the requirements of this Appendix, the system shall contain counters to record the number of hours during which the engine has been operated while the system has detected any of the following NCM:
- (a) an incorrect reagent quality;
 - (b) an interruption of reagent dosing activity;
 - (c) an impeded EGR valve;
 - (d) a failure of the NCD system.
- A.1.11.4.1.1.1. The manufacturer may use one or more counters for grouping the NCMs indicated in paragraph A.1.11.4.1.1. of this Annexure.
- A.1.11.4.1.2. Each of the counters shall count up to the maximum value provided in a 2 byte counter with 1 hour resolution and hold that value unless the conditions allowing the counter to be reset to zero are met.
- A.1.11.4.1.3. A manufacturer may use a single or multiple NCD system counters. A single counter may accumulate the number of hours of 2 or more different malfunctions relevant to that type of counter, none of them having reached the time the single counter indicates.
- A.1.11.4.1.3.1. When the manufacturer decides to use multiple NCD system counters, the system shall be capable of assigning a specific monitoring system counter to each malfunction relevant according to this Appendix to that type of counters.
- A.1.11.4.2. Principle of counters mechanism

- A.1.11.4.2.1. Each of the counters shall operate as follows:
- A.1.11.4.2.1.1. If starting from zero, the counter shall begin counting as soon as a malfunction relevant to that counter is detected and the corresponding diagnostic trouble code (DTC) has the status defined in Table A.8-2.
- A.1.11.4.2.1.2. In case of repeated failures, one of the following provisions shall apply at the choice of the manufacturer.
- (a) If a single monitoring event occurs and the malfunction that originally activated the counter is no longer detected or if the failure has been erased by a scan tool or a maintenance tool, the counter shall halt and hold its current value. If the counter stops counting when the severe inducement system is active, the counter shall be kept frozen at the value defined in Table A.8-4. or a value of greater than or equal to the counter value for severe inducement minus 30 minutes.
- (b) The counter shall be kept frozen at the value defined in Table A.8-4. or a value of greater than or equal to the counter value for severe inducement minus 30 minutes.
- A.1.11.4.2.1.3. In the case of a single monitoring system counter, that counter shall continue counting if a NCM relevant to that counter has been detected and its corresponding Diagnostic trouble code (DTC) has the status "confirmed and active". It shall halt and hold one of the values specified in paragraph A.1.11.4.2.1.2. of this Annexure, if no NCM that would justify the counter activation is detected or if all the failures relevant to that counter have been erased by a scan tool or a maintenance tool.

**Table A.8-4.
Counters and inducement**

#	DTC status for first activation of the counter	Counter value for low-level inducement	Counter value for severe inducement	Frozen value held by the counter
Reagent quality counter	confirmed and active	≤ 10 hours	≤ 72 hours	≥ 90 per cent of counter value for severe inducement
Dosing counter	confirmed and active	≤ 10hours	≤ 72hours	≥ 90 per cent of counter value for severe inducement
EGR valve counter	confirmed and active	≤ 36 hours	≤ 72hours	≥ 95 per cent of counter value for severe inducement
Monitoring system counter	confirmed and active	≤ 36 hours	≤ 72hours	≥ 95 per cent of counter value for severe inducement
NO _x threshold, if applicable	confirmed and active	≤ 10 hours	≤ 72hours	≥ 90 per cent of counter value for severe inducement

A.1.11.4.2.1.4. Once frozen, the counter shall be reset to zero when the monitors relevant to that counter have run at least once to completion of their monitoring cycle without having detected a malfunction and no malfunction relevant to that counter has been detected during 40 engine operating hours since the counter was last held (see Figure A.8-4.).

A.1.11.4.2.1.5. The counter shall continue counting from the point at which it had been held if a malfunction relevant to that counter is detected during a period when the counter is frozen (see Figure A.8-4.).

A.1.12. Illustration of the activation and deactivation and counter mechanisms

A.1.12.1. This paragraph A.1.12. of this Annexure illustrates the activation and deactivation and counter mechanisms for some typical cases. The Figures and descriptions given in paragraphs A.1.12.2., A.1.12.3. and A.1.12.4. of this Annexure are provided solely for the purposes of illustration in this Appendix and should not be referenced as examples of either the requirements of this Regulation or as definitive statements of the processes involved. The counter hours in Figures A.8-6. and A.8-7. refer to the maximum severe inducement values in Table A.8-4.. For simplification purposes, for example, the fact that the warning system will also be active when the inducement system is active has not been mentioned in the illustrations given.

**Figure A.8-4.
Reactivation and resetting to zero of a counter after a period when its value has been frozen**

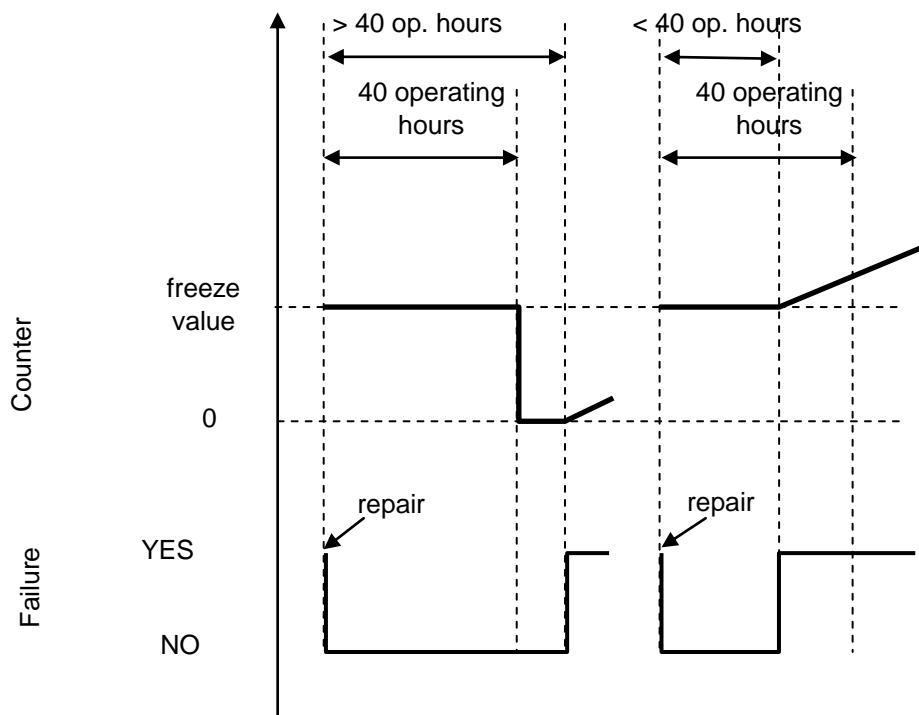

A.1.12.2. Figure A.8-5. illustrates the operation of the activation and deactivation mechanisms when monitoring the reagent availability for four cases:

- (a) use case 1: the operator continues operating the Genset in spite of the warning until Genset operation is disabled;
- (b) Adequate refilling case 1: the operator refills the reagent tank so that a level above the 10 per cent threshold is reached. Warning and inducement are de-activated;

- (c) Inadequate refilling cases 2 and 3: The warning system is activated. The level of warning depends on the amount of available reagent;
- (d) Very Inadequate refilling case 4: The low-level inducement is activated immediately.

Figure A.8-5.
Reagent availability

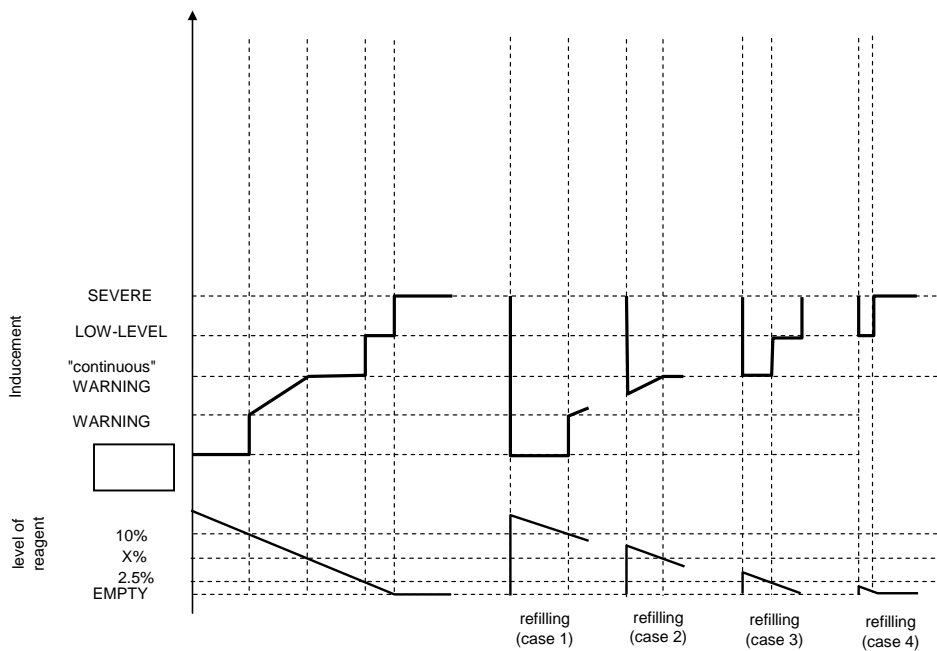

A.1.12.3. Figure A.8-6. illustrates three cases of wrong reagent quality:

- (a) use case 1: the operator continues operating the Genset in spite of the warning until Genset operation is disabled.
- (b) repair case 1 ("bad" or "dishonest" repair): after disablement of the Genset, the operator changes the quality of the reagent, but soon after, changes it again for a poor quality one. The warning, inducement and counting processes start from zero. The inducement system is immediately reactivated and Genset operation is disabled after 2 engine operating hours.
- (c) repair case 2 ("good" repair): after disablement of the Genset, the operator rectifies the quality of the reagent. However, sometime afterwards, he refills again with a poor-quality reagent. The low-level inducement system is immediately reactivated and the counter restarts from the value it had at the time of repair. The warning, inducement and counting processes restart from zero.

Figure A.8-6.
Filling with poor reagent quality

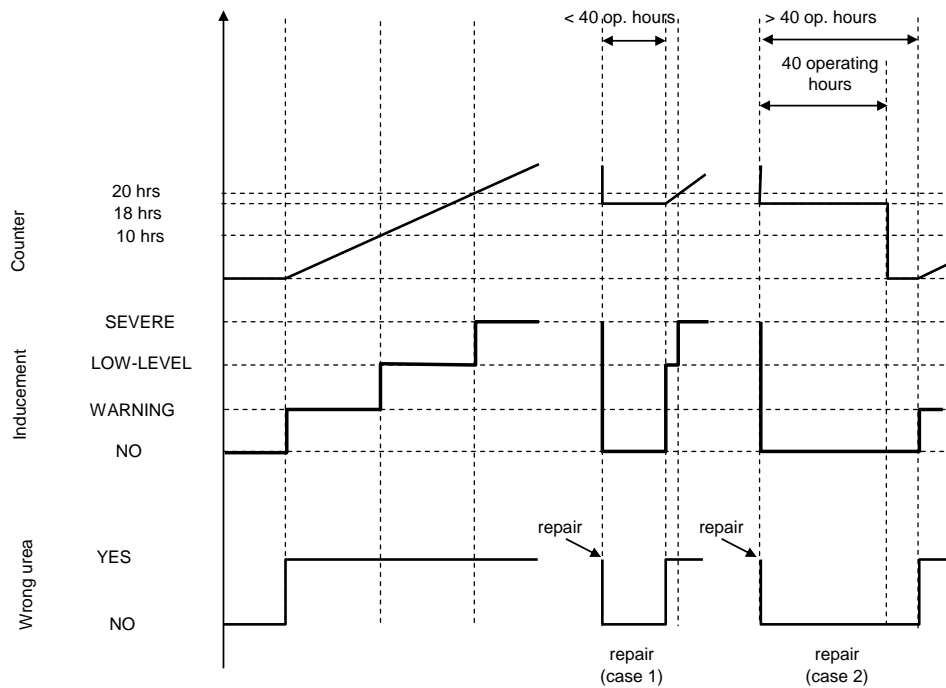

A.1.12.4. Figure A.8-7. illustrates three cases of failure of the urea dosing system. This figure also illustrates the process that applies in the case of the monitoring failures described in paragraph A.1.9. of this Annexure.

- (a) use case 1: the operator continues operating the Genset in spite of the warning until Genset operation is disabled.
- (b) repair case 1 ("good" repair): after disablement of the Genset engine, the operator repairs the dosing system. However, some time afterwards, the dosing system fails again. The warning, inducement and counting processes restart from zero.
- (c) repair case 2 ("bad" repair): during the low-level inducement time (torque reduction), the operator repairs the dosing system. Soon after, however, the dosing system fails again. The low-level inducement system is immediately reactivated and the counter restarts from the value it had at the time of repair.

**Figure A.8-7.
Failure of the reagent dosing system**

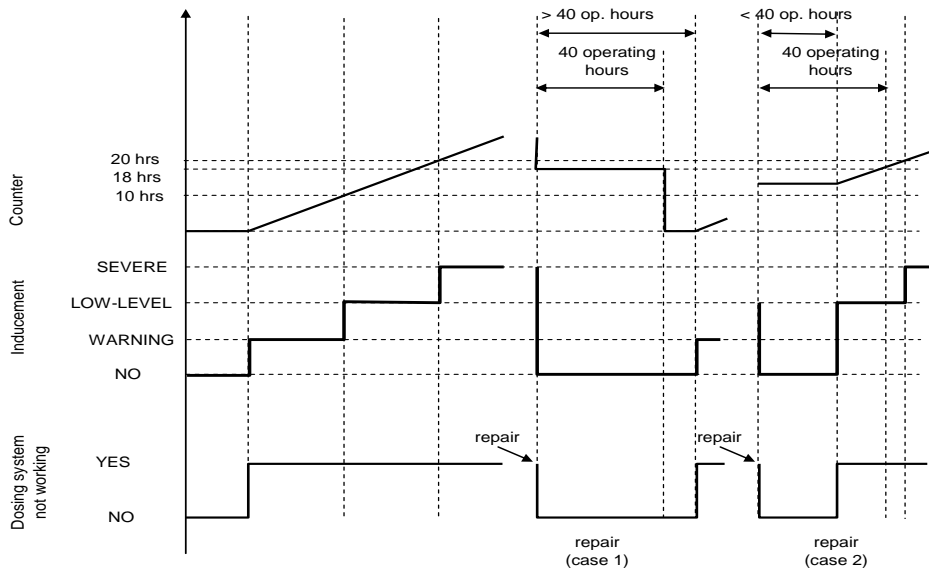

A.1.13. Demonstration of the minimum acceptable reagent concentration CD_{min}

A.1.13.1. The manufacturer shall demonstrate the correct value of CD_{min} during type approval by performing the applicable D1-3 mode constant speed cycle for constant speed engine using a reagent with the concentration CD_{min} .

A.1.13.2. The test shall follow the appropriate NCD cycle(s), permitting a closed loop NO_x control system to perform adaptation to the quality of the reagent with the concentration CD_{min} .

A.1.13.3. The pollutant emissions resulting from this test shall not exceed the NO_x threshold specified in paragraph A.1.7.1.1. of this Annexure.

A.1.13.4. Documentation of the demonstration

A.1.13.4.1. A demonstration report shall be created that documents the demonstration of the minimum acceptable reagent concentration.

The report shall:

- (a) identify the failures examined;
- (b) describe the demonstration performed including the applicable test cycle;
- (c) confirm that the pollutant emissions arising from this demonstration did not exceed the NO_x threshold specified in point A.1.7.1.1 of this Annexure;
- (d) be included in the information folder as set out in Annexure 1

A.1.14. Technical requirements for Audible Operator warning system.

This section describes technical requirements for audible operator warning system associated with NO_x Control Diagnostics. Same could be leveraged by manufacturer for warning of other faults such as engine de-rates due to safety reason however with different pattern.

A.1.14.1. Specification requirements for audible warning system

Audible operator warning system as installed on Genset application shall satisfy following requirements:

- (a) Sound intensity of the system as measured at distance of 1 m facing Genset panel with controls and displays those accompany operator warning lights shall be 80-85 decibels;
- (b) Such warning system (sound source) shall be all weather compatible and durable for life of Genset;

- (c) Shall have diagnostics associated with it including DTC inline with paragraph A.1.10 of this Annexure if tampered with;
 - (d) Manufacturer may opt to integrate such warning system within Genset enclosure or may provide an external hooter compliant with above requirements;
- A.1.14.2. Audio warning system pattern requirements
- A.1.14.2.1. Audio warning system for operator inducements shall be enabled per any of the options below:
- Option: A**
- A.1.14.2.1.1. When operator warning has become active for low-level inducement, activate visual warning with no alarms.
 - A.1.14.2.1.2. At commencement of low-level inducement, the audio warning system shall beep once in 5 seconds with 2-second-long beep. Such audio warning shall remain active as long as low-level inducement state is active.
 - A.1.14.2.1.3. At commencement of severe-level inducement, the audio warning system shall beep once in 2 seconds with 2-second-long beep. Such audio warning shall remain active when Engine Ignition is ON or Engine shutdown but ignition is ON.
- Option: B**
- A.1.14.2.1.4. Any specific pattern of alarm with specific duration and frequency of beeps that will alert the operator on Inducements as defined by the manufacturer which needs to be demonstrated at the time of testing as part of Inducement strategy
 - A.1.14.2.4. Manufacture may opt to use same audio warning pattern as paragraph A.1.14.2.1.3 of this Annexure for non-inducement fault codes those are engine and equipment safety related and will cause immediate derate or shutdown of an engine;
- A.1.14.3. Audio warning system extent requirements
- A.1.14.3.1. Audio warning associated with low-level inducement commencement shall remain active as long as low-level inducement state is active;
 - A.1.14.3.2. Audio warning associated with severe-level inducement commencement shall remain active when Engine Ignition is ON or Engine shutdown but ignition is ON.
- A.1.14.4. Details of the operator warning system activation and deactivation procedures are described in paragraph A.1.11. of this Annexure those shall apply to audio warning system;
- A.1.14.5. As part of the application for approval under this Regulation, the manufacturer shall demonstrate the operation of the audio operator warning system, as specified in paragraph A.1.10. of this Annexure;

Appendix – A.2

Reserved

Appendix – A.3

Technical details for prevention of tampering

- A.3.1. For engine types and engine families that use an ECU as part of the emission control system the manufacturer shall provide to the approval authority a description of the provisions taken to prevent tampering with and modification of the ECU including the facility for updating using a manufacturer-approved program or calibration;
- A.3.2. For engine types and engine families that use mechanical devices as part of the emission control system the manufacturer shall provide to the approval authority a description of the provisions taken to prevent tampering with and modification of the adjustable parameters of the emission control system. This shall include the tamper resistant components. Such as Fuel injection pump limiter caps or sealing of Fuel injection pump screws or special screws not adjustable by user.
- A.3.2.1. The manufacturer shall demonstrate to the Test Agency that the adjustable parameters of the emission control system cannot be easily tampered by applying reasonable forces, either:
- (a) using the tools supplied together with the engine; or,
 - (b) using ordinary tools such as screwdriver, pliers (including cutting pliers) or wrenches.
- Ordinary tools do not include: most cutting or grinding tools, drills and rotary cutters, or tools that generate excessive heat or flame.
- A.3.3. For the purpose of this Appendix, engines from different engine families may be further combined into families based upon the type and design of tamper prevention measures utilized. In order to place engines from different engine families into the same tamper prevention engine family the manufacturer shall provide confirmation to the approval authority that the measures used to prevent tampering are similar. In this case the requirements of paragraphs A.3.1. and A.3.2. of this Annexure may be performed for one representative engine and the corresponding documentation used during the type approval of all engines in the same tamper prevention engine family.
- A.3.4. Manufacturers shall provide a warning in the operator's manual stating that tampering with the engine voids the type-approval of that particular engine.

Appendix – A.4

Technical details for Remote Information and Monitoring Requirements

A.4.1. General Requirements

A.4.1.1. Gensets powered by electronically controlled engines with >56 kW power shall be equipped with remote information and monitoring system utilizing telematics.

Gensets unlike non-road machines and On road vehicles are operated typically without human intervention and does not have an 'Operator' required to be present during its operation. This makes 'Operator Warning System' in line with non-road machines difficult to follow through as well as getting timely inputs to the operator of a Genset.

A.4.1.2. Manufacturer in conjunction with GOEM shall provide a cellular data based remote information monitoring system that is capable of working with Application (App) able to work with desktop computers and cellular hand-held devices such cellphone. Such app once installed shall be able to provide essential information and warnings to Genset owner/s, operator/s highlighting any mal-function related to emission control by a suitable "Engine Malfunction" icon indicated prominently on the user interface.

A.4.1.3. Manufacturer/GOEM may choose to demonstrate the remote monitoring function as mentioned in A.4.1.2 on engine test bench during engine type approval and COP or on the Genset during Genset type approval & COP.

ANNEXURE – 9

Installation in the Genset Application

9.1. Information and instructions intended for OEMs and end-users.

- 9.1.1. A manufacturer shall not supply to GOEMs or end-users any technical information related to the particulars provided for in this Regulation which diverges from the particulars approved by the Type Approval Authority;
- 9.1.2. The manufacturer shall make available to GOEMs all relevant information and instructions that are necessary for the correct installation of an engine in Genset, including a description of any special conditions or restrictions linked to the installation or use of the engine;
- 9.1.3. The manufacturer shall make available to GOEMs all relevant information and necessary instructions intended for the end-user, including a description of any special conditions or restrictions linked to the use of an engine.
- 9.1.4. Details of the relevant information and instructions for the GOEMs are set out in Appendix 1 to Annexure 9.

9.2. Obligations of GOEMs concerning the installation of engines

- 9.2.1. GOEMs shall install approved engines in Genset in accordance with the instructions provided by the manufacturer pursuant to paragraph 9.1.2, and in a manner that does not adversely affect the engine's performance with regard to its gaseous pollutant emissions;
- 9.2.2. Where an GOEM does not follow the instructions referred to in paragraph 9.2.1., or modifies an engine in the course of its installation of genset, in a manner that adversely affects the engine's performance with regard to its gaseous pollutant emissions, that GOEM shall be considered to be a manufacturer for the purposes of this Regulation and shall, in particular, be subject to the obligations laid down in clauses 3, 4 and 5 of this Regulation;
- 9.2.3. OEMs shall install type-approved engine(s) in genset(s) only in accordance with the kinds of exclusive use provided for the engine categories set out in clause 1.
- 9.2.5. Details of the relevant information and instructions for the end-users are set out in Appendix 2 to Annexure 9;
- 9.2.6. The safety code of practice to be followed along with the instructions provided by the manufacturer pursuant to paragraph 9.1.2, and in a manner that does not adversely affect the engine's performance with regard to its gaseous pollutant emissions; The test agency will certify the installation of the engine in GENSET canopy as per safety code of practice. The separate document 'A4' named "SAFETY CODE OF PRACTICE" shall be referred for more clarification. The noise level certificate shall be issued only after compliance of GENSET to safety code of practice.

Appendix – 1

Details of the relevant information and instructions for the GOEMs

- A.1.1. As required by paragraph 9.1., the manufacturer shall provide to the GOEM all relevant information and instructions to ensure that the engine conforms to the approved engine type when installed in Gensets. Instructions for this purpose shall be clearly identified to the GOEM;
- A.1.2. The instructions may be provided on paper or a commonly used electronic format;
- A.1.3. Where a number of engines requiring the same instructions are supplied to the same GOEM it shall be necessary to provide one set of instructions at minimum;
- A.1.4. The information and instructions to the OEM shall include at minimum:
 - A.1.4.1. installation requirements to achieve the emissions performance of the engine type, including the emission control system, that shall be taken into account to ensure the correct operation of the emissions control system;
 - A.1.4.2. a description of any special conditions or restrictions linked to the installation or use of the engine, as noted on the communication set out in Annexure 1
 - A.1.4.3. a statement indicating that the installation of the engine shall not permanently constrain the engine to exclusively operate within a power range corresponding to a (sub-)category with gaseous pollutant emission limits more stringent than the (sub-) category the engine belongs to;
For e.g.:
 - c) Engine certified for > 56 KW power can be permanently constrained to power less than 56 KW
 - d) However, engine certified for > 560 KW power cannot be permanently constrained to power less than 560 KW
 - A.1.4.4. for engine families to which appendix 2 of annexure 7 of this Regulation applies, the upper and lower boundaries of the applicable control area and a statement indicating that the installation of the engine shall not constrain the engine to exclusively operate at speed and load points outside of the control area for the torque curve of the engine;
 - A.1.4.5. where applicable, design requirements for the components supplied by the OEM that are not part of the engine and are necessary to ensure that, when installed, the engine conforms to the approved engine type;
 - A.1.4.6. where applicable, design requirements for the reagent tank, including freeze protection, monitoring of reagent level and means to take samples of reagent;
 - A.1.4.7. where applicable, information on installation of a non-heated reagent system;
 - A.1.4.9. where applicable, a statement indicating that the OEM shall provide a warning system as set out in Appendices 1, 2 and 3 of Annexure 8;
 - A.1.4.10. where applicable, information on the interface between the engine and genset for the operator warning system, referred to in paragraph A.1.4.9.;
 - A.1.4.11. where applicable, information on the interface between the engine and Genset for the operator inducement system, as set out in Annexure 8;
 - A.1.4.12. where applicable, information on a means to temporarily disable the operator inducement as defined in Annexure 8;
 - A.1.4.13. where applicable, information on the inducement override function as defined in Annexure 8;
 - A.1.4.14. Reserved
 - (a) Reserved
 - (b) Reserved

(c) Reserved

A.1.4.15. In the case of a constant-speed engine equipped with alternative speeds as set out in paragraph 4.1.2.3. of Clause 4:

- (a) a statement indicating that the installation of the engine shall ensure that:
 - i. the engine is stopped prior to resetting the constant-speed governor to an alternative speed; and,
 - ii. the constant-speed governor is only set to the alternative speeds permitted by the engine manufacturer;
- (b) details of each (sub-)category and operating mode (speed operation) for which the engine is type-approved and may be set when installed;

A.1.4.16. In the case that the engine is equipped with an idle speed for start-up and shut-down, a statement indicating that the installation of the engine shall ensure that the constant-speed governor function is engaged prior to increasing the load-demand to the engine from the no-load setting.

A.1.5. The manufacturer shall provide to the GOEM all information and necessary instructions that the GOEM shall provide to the end-users in accordance with Appendix 2 to Annexure 9.

Appendix – 2

Details of the relevant information and instructions for the end-users

- A.2.1. The GOEM shall provide to the end-users all information and necessary instructions for the correct operation of the engine in order to maintain the gaseous pollutant emissions of the engine within the limits of the approved engine type or engine family. Instructions for this purpose shall be clearly identified to the end-users.
- A.2.2. The instructions to the end-users shall be:
 - A.2.2.1. written in a clear and non-technical manner using the same language that is used in the instructions to end-users for gensets;
 - A.2.2.2. be provided on paper or, alternatively, a commonly used electronic format;
 - A.2.2.3. be part of the instructions to end-users for the Genset,
- A.2.3. The information and instructions to the end-users shall include at least:
 - A.2.3.1. a description of any special conditions or restrictions linked to the use of the engine, as noted on the type-approval communication;
 - A.2.3.2. a statement indicating that the engine, including the emissions control system, shall be operated, used and maintained in accordance with the instructions provided to the end-users in order to maintain the emissions performance of the engine within the requirements applicable to the engine's category;
 - A.2.3.3. a statement indicating that no deliberate tampering with or misuse of the engine emissions control system should take place; in particular, with regard to deactivating or not maintaining an exhaust gas recirculation (EGR) or a reagent dosing system;
 - A.2.3.4. a statement indicating that it is essential to take prompt action to rectify any incorrect operation, use or maintenance of the emissions control system in accordance with the rectification measures indicated by the warnings referred to in paragraph A.2.3.5. and A.2.3.6.;
 - A.2.3.5. detailed explanations of the possible malfunctions of the emissions control system generated by incorrect operation, use or maintenance of the installed engine and due to failure to emission control system components, accompanied by the associated warning signals and the corresponding rectification measures;
 - A.2.3.6. detailed explanations of the possible incorrect use of the Genset that would result in malfunctions of the engine emissions control system, accompanied by the associated warning signals and the corresponding rectification measures;
 - A.2.3.7. for gensets with an operator warning system, a statement indicating that the operator will be informed by the operator warning system when the emission control system does not function correctly;
 - A.2.3.8. for Genset with an operator inducement system a statement indicating that ignoring the operator warning signals will lead to the activation of the operator inducement system, resulting in an effective disablement of genset operation;
 - A.2.3.9. for Genset with an inducement override function for releasing full engine power justified by safety concerns or to allow for self-healing diagnostics, information about the operation of this function;
 - A.2.3.10. where applicable, explanations of how the operator warning and inducement systems referred to in paragraphs A.2.3.7., A.2.3.8. and A.2.3.9. operate, including the consequences, in terms of performance and fault logging, of ignoring the warning system signals and of not replenishing, where used, the reagent or rectifying the problem identified;
 - A.2.3.11. for genset with a means to disable the operator inducement, information about the operation of this function, and a statement indicating that this function shall be only activated in case of emergencies, that any activation will be recorded in the on-board computer log and that Central

or State pollution Control Board inspection authorities will be able to read these records with a scan tool;

- A.2.3.12. information on the fuel(s) necessary to maintain the performance of the emissions control system in particular:
 - (a) reserved
 - (b) where additional fuels, fuel mixtures or fuel emulsions are compatible with use by the engine, as declared by the manufacturer and stated in the type-approval communication, these shall be indicated. Such fuel type shall be constrained by alternate fuel definitions of this Regulation;
- A.2.3.13. information on the lubrication oil specifications necessary to maintain the performance of the emissions control system;
- A.2.3.14. where the emission control system requires a reagent, the generic name, characteristics of that reagent, including the type of reagent, information on concentration when the reagent is in solution, operational temperature conditions and reference to Indian and international standards for composition and quality, consistent with the specification set-out in the engine type-approval;
- A.2.3.15. where applicable, instructions specifying how consumable reagents have to be refilled by the operator between normal maintenance intervals. They shall indicate how the operator should refill the reagent tank and the anticipated frequency of refill, depending upon of the genset based on average per day operation;
- A.2.3.16. a statement indicating that in order to maintain the emissions performance of the engine, it is essential to use and refill reagent in accordance with the specifications set out in clause A.2.3.14. and A.2.3.15.;
- A.2.3.17. scheduled emission-related maintenance requirements including any scheduled exchange of critical emission-related components;

ANNEXURE – 10

ALTERNATE FUEL SYSTEM SAFETY STANDARDS

Sr. No.	Component	Certifying / Verifying Authority	Applicable Standards
1	Regulator (For CNG & BIO-CNG) / Regulator and Vaporizer(LNG)*	Testing of the component as per IS: 15713 or ISO-15500 by test agency. Alternatively, test agency to verify the test certificate or report conforming to the above standard issued by accredited testing laboratory.	IS: 15713 or ISO -15500
		LNG regulator and Vaporizer / heat exchanger shall meet requirements of UN R110 or equivalent standard	UN R 110 or equivalent standard
2	Gas-Air Mixer*	Testing of the component as per IS: 15714 or ISO-15500 by test agency. Alternatively, test agency to verify the test certificate or report conforming to the above standard issued by accredited testing laboratory.	IS: 15714 or ISO-15500
3	Gas Injector*	Testing of the component as per ISO-15500-7 by test agency. Alternatively, test agency to verify the test certificate or report conforming to the above standard issued by accredited testing laboratory.	ISO-15500-7
4	Gas Solenoid Valve / Automatic Shutoff valve*	Testing of the component as per IS: 15712 or ISO-15500 by test agency. Alternatively, test agency to verify the test certificate or report conforming to the above standard issued by accredited testing laboratory.	IS: 15712 or ISO-15500
		Automatic shutoff valve of LNG System (which comes in contact with LNG shall meet requirements of UN R110 or equivalent standards)	Automatic shutoff Valve for LNG System : UN R110 or equivalent standards
5	Testing of Conduit*	Testing of the component or verification of certificate or test report as per IS: 15715 by test agency.	IS: 15715
6	CNG / BIO-CNG / LNG fuel line		
6.1	High pressure exceeding 100 kPa*		
6.1.1	Exceeding 2.15 MPa		

	Rigid pipe	Testing of the component or verification of certificate or test report as per IS : 15716 by test agency.	IS: 15716
		LNG rigid pipeline shall meet requirements of UN R 110 or IS : 15716 or equivalent standard.	UN R 110 or IS: 15716 or equivalent standard.
	Flexible hose	Testing of the component or verification of certificate or test report as per IS 15718 by test agency.	IS 15718 or AIS-028 (Rev. 1) (Part A)
		LNG flexible pipeline shall meet requirements of UN R110 or IS: 15718 or equivalent standard.	UN R 110 or IS: 15718 or equivalent standard
6.1.2	Pressure upto 2.15 Bar	Testing of the component or verification of certificate or test report as per IS : 15722 by test agency.	IS : 15722 with amendments
		LNG pipeline shall meet requirements of UN R110 or IS : 15722 or equivalent standard.	UN R 110 or IS: 15722 or equivalent standard
6.2	Joints and connections*	Testing by test agency.	Clause 3.1.4.1, 3.2.1 (b) of AIS-028 (Rev. 1) (Part A)
		LNG joints & connection shall meet requirements of UN R 110 or equivalent standard	UN R 110 or equivalent standard
7	Compartment or Sub-compartment*	Testing of the component or verification of certificate or test report as per IS: 15720 by test agency.	IS: 15720
8	Specific LNG components	Following specific components, as applicable shall meet requirements of UN R 110 or equivalent standard LNG Fuel pump, Pressure Relief valves, Pressure sensor, check valve, excess flow valve, manual valve and non-return valve.	UN R 110 or equivalent standard
9	Safety check for installation of Gaseous fuel system	Safety checks to be carried out by test agency as per AIS-028 (Rev.1) (Part A)	Relevant clauses of AIS-028 (Rev. 1) (Part A)
10	Electrical wiring and harness		AIS 028
11	Non-moisture retaining hard rubber/equivalent material		AIS 028
12	Electrical fuses		AIS 028

* Certificate issued by accredited testing agency of the country of origin or a report issued by internationally accredited test laboratory may also be accepted.

Note 1 - Only the standards, as amended from time to time, as mentioned above, shall be referred for compliance.

Note 2 - Components downstream the Heat exchanger / vaporizer shall be considered as CNG components and prevailing Indian standard / ISO standard or equivalent standards shall be acceptable

****END****

This page intentionally kept blank

Part – A3

Portable Generator sets

1. SCOPE

This Part-A3 document lays down the applicability and requirements, system & procedure for compliance to the rules vide notification no. GSR 804(E.) dated 3-Nov-2022 on emission limits for Portable Generator sets (PI engines below 19kW and up to 800 cc displacement) application, issued by Ministry of Environment, Forests & Climate change, Government of India.

Portable Generator sets running on,

- Gasoline fuel
- Dedicated alternate fuels
- Bi-fuel run either on Gasoline or on any one of the alternate fuels*

*Alternate fuels - Natural Gas/ Bio-CNG, LPG

Following standards has been referred while drafting this system & procedure.

Sr No.	Standard	Title
1	ISO 8178-1 :2017 ISO 8178-1 :2020	Reciprocating internal combustion engines — Exhaust emission measurement — Part 1: Test-bed measurement systems of gaseous and particulate emission
3	ISO 8178-4: 2017 ISO 8178-4: 2020	Reciprocating internal combustion engines — Exhaust emission measurement — Part 4: Steady-state and transient test cycles for different engine application
4	ISO 8178-7:2015	Reciprocating internal combustion engine-Exhaust emission measurement-Part-7: Engine family determination
5	IS 14599 :1999 (Reaffirmed 2019)	Automotive vehicles- performance requirements (Measurement of Power, SFC, Opacity) of positive and compression ignition engines- Method of test
6	40 CFR Part 1039	US EPA Regulation: 40 CFR Part 1039 - Control of emissions from new and in-use nonroad compression-ignition engines
7	40 CFR Part 1065	US EPA Regulation: 40 CFR Part 1065 – Engine testing procedures

2. DEFINITION & ABBREVIATIONS

2.1 DEFINITIONS

1. **“Approval of a genset (genset family)”** means the approval of portable genset type/portable genset family with regards to the level of the gaseous emission pollutants by the genset;
2. **“Declared electrical power output (VA)”** means rated gross electrical power declared by manufacturer for type approval at declared rated speed;
3. **“Mechanical power output (kW)”** means mechanical power at engine crank shaft output at rated speed which is calculated as $V \times A / 1000 \times \text{Alternator efficiency}$;
4. **“Internal combustion engine (ICE)”** means an engine, which works on the either compression-ignition principle or positive ignition principle utilising liquid, gaseous or combination of both fuels;
5. **“Emissions-related defect”** means a deviation from normal production tolerances in design, materials, system or assembly that affects any parameter, specification or component belonging to the emission control system. A missing component may be considered to be an emission-related defect;
6. **“Emission control system”** means the exhaust after treatment system, the electronic management controllers of the engine system (if utilized) and any emission related component of the engine system in the exhaust which supplies an input to or receives an output from these controllers and when applicable the communication interface between the engine system electronic control unit (ECU) and any other power train with respect to emissions management;
7. **“Engine system”** means the engine, the emission control system and the communication interface (hardware and messages) between the engine system electronic control unit (ECU) and any other power train;
8. **“Genset family”** means a manufacturer’s grouping of engine systems which, through their design have similar exhaust emission characteristics, all members of the family must comply with the applicable emission limit values described in Clause 3.1. Also refer ISO 8178-7;
9. **“Parent genset”** means a genset selected from genset family in such a way that its emissions characteristics will be representative for that genset family and that it complies with the requirements set out in ISO 8178-7
10. **“Genset type”** means a category of genset, which do not differ in such essential respects as genset characteristics as defined in ISO 8178-7
11. **“High idle speed”** High idle speed is the speed reached under governor control at full throttle condition.
12. **“Exhaust after treatment system”** means ‘a catalyst (oxidation or 3-way), or any other emission-reducing device that is installed downstream of the engine. This definition excludes exhaust gas recirculation, which, where fitted is considered an integral part of the engine system;
13. **“Power generating set or Genset”** means any equipment which is used for electric power generation in absence or failure of grid power utilizing engine system defined in this document as prime mover;
14. **“Percent load”** means the fraction of available current(A)/mechanical power at a rated engine speed.
15. **“Test Cycle”** means a sequence of test points each with a defined speed and torque to be followed by the engine during standardised emission assessment test. Also refer ISO 8178-4;

16. **For Domestic products**, Date of Manufacture means the date on which the engine is invoiced; This is in with consideration the production volume declaration for COP.
17. **For Imported products**, Date of Import means the date of payment of custom duties applicable to the Genset; This is with consideration with the import volume declaration for COP
18. **“Manufacturer”** means engine or Genset manufacturer, importer or, assembler (as noted in notification);
19. **“Applicable emission limit”** means an emission limit to which an engine is subject to for approval;
20. **“Constant speed engine”** means an engine whose type approval or certification is limited to constant-speed operation. Engines whose constant-speed governor function is removed or disabled are no longer constant-speed engines;
21. **“Constant speed operation”** means engine operation with a governor that automatically controls the operator’s demand to maintain engine speed, even under changing load. Governors do not always maintain exactly constant speed.
22. **“Engine governed speed”** means the engine operating speed when it is controlled by the installed governor;
23. **“Critical emission related components”** means the components which are designed primarily for emission control, that is, any exhaust after-treatment system, the electronic engine control unit and its associated sensors and actuators, fuel injection equipment and it’s integral control actuators;
24. **“Critical emission related maintenance”** means the maintenance to be performed on critical emission-related components;
25. **“Discrete mode”** means relating to a discrete mode type of steady-state test, as described in ISO 8178-4.
26. **“Electronic control unit (ECU)”** means an engine’s electronic device that uses data from engine sensors to control engine parameters as primary function. ECU may contain more functionality than stated above of interest;
27. **“Emission control strategy”** means a combination of an emission control system with one base emission control strategy and with one set of auxiliary emission control strategies, incorporated into the overall design of an engine or Genset into which the engine is installed;
28. **“Emission related maintenance”** means maintenance which substantially affects emissions, or which is likely to affect emissions performance deterioration of the vehicle or the engine and exhaust after treatment system during normal in-use operation;
29. **“Non-emission related maintenance”** means maintenance which does not substantially affect emissions, and which does not have a lasting effect on the emissions performance deterioration of the machine or the engine during normal in-use operation once the maintenance is performed;
30. **“Gaseous pollutant”** means carbon monoxide (CO), hydrocarbons (HC – assuming a ratio of C₁H_{1.85}) and oxides of nitrogen (NO_x), the last named being expressed in nitrogen dioxide (NO₂) equivalent; Actual CH ratio of the test fuel may be considered as per fuel specification certificate.
31. **“Oxides of Nitrogen (NO_x)”** means compounds containing only nitrogen and oxygen as measured by the procedures specified in this Regulation. Oxides of nitrogen are expressed quantitatively as if the NO is in the form of NO₂, such that an effective molar mass is used for all oxides of nitrogen equivalent to that of NO₂.

32. **“Hydrocarbon (HC)”** means Total Hydrocarbon (THC), non-methane hydrocarbon (NMHC) as applicable. Hydrocarbon generally means the hydrocarbon group on which the emission standards are based for each type of fuel and engine;
33. **“Non-methane hydrocarbons (NMHC)”** means the sum of all hydrocarbon species except methane;
34. **“Idle speed”** means the lowest engine speed with minimum load (greater than or equal to zero load), where an engine governor function controls engine speed. For engines without a governor function that controls idle speed, idle speed means the manufacturer-declared value for lowest engine speed possible with minimum load. Note that warm idle speed is the idle speed of a warmed-up engine.
35. **“Portable Generator”** Electric Generator is defined as Portable if it suits the definition and satisfies the following condition.
- A portable generator is the combination of an electrical generator and an engine (prime mover) mounted together to form a single piece of equipment. This combination is also called an engine-generator set or a gen-set which usually can be moved, pulled, pushed by a person, and not build permanently into a structure such as power house or station.
- Portable Electric Generator, a generator which satisfy the following condition-
- Power output is up to 19 kW & up to 800 cc engine displacement
 - Power by PI air cooled engine
 - It is on Hand-cart mounted units
36. **“Placing on the market”** means the action of making available a product covered by this Regulation on the market of a country applying this Regulation, for payment or free of charge, with a view to distribution and/or use in the country
37. **“Type approval”** means the approval of portable genset type/portable genset family with regard to its emissions measured in accordance with the procedures specified in this Regulation;

2.2 Abbreviations

A	Ampere
BSFC	Brake-specific fuel consumption
BIS	Bureau of Indian Standards
CPCB	Central Pollution Control Board
C ₁	Carbon 1 équivalent hydrocarbon
cc	Cubic Centimetre
CH ₄	Methane
C ₂ H ₆	Ethane
C ₃ H ₈	Propane
CNG	Compressed Natural Gas
CO	Carbon monoxide
CO ₂	Carbon dioxide
COP	Conformity of Production
COP-Year	Period starting 1 st July of preceding year till 30 th June of subsequent year
ECM	Electronic control module
IS	Indian Standard
GOEM	Genset Original Equipment Manufacturer
HC	Hydrocarbon
H ₂ O	Water
ISO	International Organization for Standardization
LPG	Liquefied Petroleum Gas
NMHC	Non-methane hydrocarbon
NO _x	Oxides of nitrogen
NO	Nitric oxide
NO ₂	Nitrogen dioxide
O ₂	Oxygen
PI	Positive Ignition (Engine)
PPM	Part per million
RMS	Root-mean square
S	Sulphur
THC	Total hydrocarbonos
RHC	Reactive Hydrocarbones
V	Voltage

3 Exhaust Emission Limits, Applicability and Requirement

3.1 Exhaust Emission Limits

The emissions of the carbon monoxide, the emissions of hydrocarbons and the emissions of the oxides of nitrogen obtained during emission certification and conformity of production emission test/s conducted in accord with in Annexure 4 of this regulation shall not exceed the amount shown in Table 1 below:

Table 1
Emission limits for Portable Genset engines

Class	Engine displacement (cc)	CO (g/kWh)	NOx +THC NOx + NMHC NOx + RHC (g/kWh)	Test Cycle
1	Up to 99 cc	250	10	D1-3-mode test cycle as specified in ISO 8178 Part 4
2	> 99 and up to 225 cc	250	8	
3	> 225 cc	250	6	

Notes:

- 1) The test shall be done on resistive load bank.
- 2) The testing shall be done as per test procedures mentioned in Annexure 4.
- 3) Test method shall be as specified in ISO 8178: Part 1 & 4, Reciprocating internal combustion engines — Exhaust emission measurement; Steady-state and transient test cycles for different engine applications. The measurement mode shall be D1-3 mode cycle specified under ISO 8178: Part 4 (Weighting Factor of 0.3 for 100 percent load, 0.5 for 75 percent load and 0.2 for 50 percent load). Detail procedure is laid down in Annexure 4 of this document.
- 4) Every manufacturer, importer or assembler (hereafter referred as manufacturer) of the genset manufactured or imported into India shall obtain Type Approval and comply with Conformity of Production (COP) requirements of their product(s) for emission limits which shall be valid for next COP year.
- 5) The above mentioned limit shall be applicable to Type approval and Conformity of Production (COP) carried out by authorized test agencies.
The term 'COP year' means the period from 1st July of a preceding calendar year to 30th June of the following year
- 6) Specific provisions on total hydrocarbon (HC) limits for fully and partially gaseous-fuelled engines (This shall apply to dual fuel engines)
- 7) NOx + NMHC shall be measured in case of NG genset. NMHC shall be equal to 0.3×Total Hydrocarbon (THC) in case of NG. Alternatively, NMHC can be measured by subtracting CH₄ emission from THC.
NOx + RHC shall be measured in case of LPG genset and RHC is equal to 0.5×THC in case of LPG
- 8) Testing shall be on complete genset which includes silencer, air filter, alternator, canopy etc. the prototype shall be acceptable.

3.2 Rounding off

Determine the official emission result for each pollutant to at least one more decimal place than the applicable standard. then round the figure to the same number of decimal places as the emission standard. Compare the rounded emission levels to the emission standard for each emission-data engine. In the case of NOX+HC standards, add the results before rounding. Test report shall have both, the final rounded certificate emission result and test result before rounding for better clarity on the decision.

Use the following rounding convention

- i. If the first (left-most) digit to be removed is less than five, remove all the appropriate digits without changing the digits that remain. For example, 3.141593 rounded to the second decimal place is 3.14.
- ii. If the first digit to be removed is greater than five, remove all the appropriate digits and increase the lowest-value remaining digit by one. For example, 3.141593 rounded to the fourth decimal place is 3.1416.
- iii. If the first digit to be removed is five with at least one additional non-zero digit following the five, remove all the appropriate digits and increase the lowest-value remaining digit by one. For example, 3.141593 rounded to the third decimal place is 3.142.
- iv. If the first digit to be removed is five with no additional non-zero digits following the five, remove all the appropriate digits, increase the lowest-value remaining digit by one if it is odd and leave it unchanged if it is even. For example, 1.75 and 1.750 rounded to the first decimal place are 1.8; while 1.85 and 1.850 rounded to the first decimal place are also 1.8. Note that this rounding procedure will always result in an even number for the lowest-value digit.

Examples-

#		1	2	3	4	5	6
1	Measured value - HC+NOx	0.49	0.50	5.49	5.50	6.49	6.50
2	Emission Limit	6	6	6	6	6	6
3	Final rounded certificate emission value	0	1	5	6	6	7
4	Decision Pass/Fail	Pass	Pass	Pass	Pass	Pass	Fail

Note: Rounding Reference taken form US EPA Regulation 40 CFR -1039 and 40 CFR- 1065

3.3 Gross Power & Speed tolerance

The measured power and speed/frequency may differ from the power and speed/frequency declared by manufactured as specified below.

#	Gross Power Tolerance	Speed/Frequency Tolerance
Type Approval	± 5% at rated	± 2% at rated & all part load points
COP	± 6% at rated	

3.4 Compliance to Safety

All Genset run on dedicated Natural Gas (NG) or Liquefied Petroleum Gas (LPG) or Bio-CNG, Gasoline and Natural Gas (NG)/ Liquefied Petroleum Gas (LPG), shall meet Safety requirements prescribed in the SAFETY CODE OF PRACTICE as per specified in Part A4.

3.5 Additional requirement for variable speed portable generator sets

Additional requirement for variable speed portable generator set shall be applicable as set out details in Annexure 8 of this Regulation.

4 Type Approval Administrative Procedure

4.1 Genset type and Genset family

4.1.1. Genset type

The technical features of an Genset type shall be those defined in its information document drafted in accordance with the template set out in Annexure 1.

4.1.2. Genset family criteria

4.1.2.1. General

For type approval and conformity of production certification, the manufacturer genset range shall be divided into model families consisting of parent genset and its variant(s).

Genset family shall be the grouping of genset, which through their design are expected to have similar exhaust emission characteristic where member of the family shall comply with the applicable emission values.

Parent genset shall be the genset selected from the genset family, in such a way that it will incorporate those features which will adversely affect the emission level of the relevant exhaust emission.

4.1.2.2. Genset family formation & choice of the parent genset

The essential characteristic of the genset family, the parameters defining the genset family, the determination of a genset family and the criteria for choosing the parent genset shall be taken according to the guideline given in ISO 8178-7 Reciprocating internal combustion Engine-Exhaust Emission Measurement-Part-7: Engine family determination. However, the decision of selection of parent genset and family classification by the authorized test agency shall be final.

For identification, the manufacturer shall designate the families as F1, F2, F3.... Fn.

The manufacturer shall provide to the type approval authority the appropriate information relating to the emissions levels of the members of the genset family

4.2 Selection of Certifying Agency

4.2.1. Following test agencies are currently approved by the Nodal Agency Central Pollution Control Board (CPCB) for purpose of type approval and subsequently conformity of production compliance process and may be revised from time to time.

- a) Automotive Research Association of India (ARAI, Pune)
- b) International Centre for Automotive Testing (ICAT, Manesar)
- c) Indian Institute of Petroleum (IIP, Dehradun)

4.2.2. One supplier shall submit application for Type Approval to only one certification agency for all its families / models out of those approved.

4.2.3. The same certification agency shall be responsible for carrying out the verification of Conformity of Production (COP) for that manufacture

4.2.4. For a new OEM or importer, selection of technical agencies for type approval certification and subsequently conformity of production shall be applicant's choice among the technical agencies published by central pollution control board (CPCB) in paragraph 4.2.1 and as amended from time to time.

4.2.5. For any reason if any manufacturer wants to change the certification agency, he shall apply to the nodal agency well in advance with justifiable reason. The nodal agency, after consultation with the existing certification agency/ standing committee, may approve the change, if found justified. If approved, the nodal agency shall inform to the parties concerned.

- 4.2.6. On receipt of information for change in certification agency from the nodal agency, the previous certification agency shall authenticate all the relevant document of the model (type approval as well as COP verification) and forward the same to the new certification agency. The certification agency shall be responsible for carrying out the type approval testing and COP verification for the manufacturer, in future.

4.3 Application of type approval

- 4.3.1 The application shall be made in the format prescribed in **Appendix -1** and must be complete in all respect. Appendix -1 shall be submitted to nodal agency and on its written acceptance, genset specification related documents to be submitted to the test agency.
- 4.3.2 The application for approval of genset or genset family with regard to the level of the emission of gaseous pollutants shall be submitted by the genset manufacturer or by a duly accredited representative.
- 4.3.3 For each genset family, the manufacturer must submit an application to the certification agency, selected as above.
- 4.3.4 The application must be signed by the authorized representative of the manufacturer.
- 4.3.5 It shall be accompanied by the undermentioned documents and the following particulars:
- A description of the genset type comprising the particulars referred to in clause 4.1. of this Regulation and if applicable the particulars of the genset family as referred to in paragraph 4.1.3. to this Regulation. For the purpose of identification, the manufacturer shall designate the genset families as F1, F2, F3 Fn in consultation with technical agency;
- 4.3.6 Testing of the parent model, shall, normally, be sufficient for type approval of the family. The Testing agency has the option to carry out the testing of more than one model in the family to satisfy itself, subject to parent genset-concept as per ISO 8178-7.
- 4.3.7 Genset conforming to the genset type characteristics described in clause 4.1. shall be submitted to the Test Agency responsible for conducting the approval tests. If the Test Agency determines that the submitted genset does not fully represent the genset family described in clause 4.1, an alternative and, if necessary, an additional genset shall be submitted for test. A prototype can be submitted; however, it must be completely built up and conforming to the design to be productionized. Relevant authorised valid document for the alternator efficiency declaration shall be submitted.
- 4.3.8 During Type Approval test, the manufacturer shall submit the qualified emission test data of all the remaining variant genset, other than the parent genset, which is chosen for emission test by the test agency of the family along with all other documents.
- 4.3.9 At later stage if the manufacturer submits the application for type approval of a model, the Testing agency shall ascertain whether the model can be classified as belonging to a family of model(s) already certified. If the model does not belong to a family already certified, the Testing agency shall proceed with the testing of the model for type approval with issuance of new and unique genset emissions family certification upon qualification;
- 4.3.10 If the model belongs to a family already certified, the Testing agency shall decide whether the specific testing of the model is required. In case the specific testing of the model is not required, the type approval certificate for the family may be extended to include the model. In such case qualified emissions data shall be submitted to agency by manufacturer during application;
- 4.3.11 The Testing agency shall intimate its decision to the applicant within a fortnight of receipt of the application, indicating need and plan (schedule) of testing for type approval;
- 4.3.12 In case of alternate fuel (Natural Gas/Bio-CNG, LPG) running generator sets, manufacture to

ensure that the related genset components shall have been approved for safety compliance in advance and genset with certified components shall be submitted for type approved. Safety compliance certificates of all related components shall be submitted along with type approval application. Safety compliance shall meet requirements prescribed in the SAFETY CODE OF PRACTICE as per Part A4 of this Regulation. Manufacturer shall apply separately to test agency for safety compliance certification.

4.4 Type Approval

- 4.4.1. No person or agency shall sale, import or use genset in India without valid Type Approval Certificate and Conformity of production Certificate referred to in clause 4.5. and 5.4 of this Regulation;
- 4.4.2. In order to receive a type approval of genset type or genset family, the manufacturer shall demonstrate compliance, of the genset type or genset family with the provisions of this Regulation. The manufacturer shall also ensure the use of fuels as specified in Annexure 6.
- 4.4.3. All the type approval tests shall be conducted in the technical agency laboratory. In case the required test facilities are accredited by the technical agency, the type approval and / or COP tests can be carried out at manufacturer's laboratory also if reasons call for. In case the test is to be carried out at any overseas test facilities, the same shall be informed to the Nodal Agency by technical agency. The technical agency will submit a copy of accreditation letter highlighting the details of test facilities available in the manufacturer's laboratory to the Nodal Agency;
- 4.4.4. In case of the manufacturer approaches the technical agency for the first time, such manufacturer should complete the COP test(s) within three months from the commencement of commercial production or importation of 100 units whichever is earlier.
- 4.4.5. The Type Approval Authority shall put together an information package consisting of the information folder accompanied by the test report and all other documents added by the technical service or by the Type Approval Authority to the information folder in the course of carrying out their functions ('the information package'). The information package shall include an index listing its contents, suitably numbered or otherwise marked so as to clearly identify all the pages and the format of each document, in order to present a record of the successive steps in the management of the type approval, in particular the dates of revisions and updating;
- 4.4.6. The approval authority shall ensure that the information contained in the information package is available for a period of at least 10 years following the end of the validity of the type approval concerned;

4.5 Certificate of Type Approval and Validity

- 4.5.1 After verification of genset(s) for the type approval, the technical agency shall issue a type approval report to manufacturer within one month from date of testing completion indicating acceptance or rejection decision and reason thereof. If the genset(s) submitted for approval pursuant to clause 4.3. of this Regulation. Approval of that genset type(s) or genset family(ies) shall be granted by the technical agency through issue of Type Approval Certificate as per format prescribed in Annexure 2 along with report. Copy of certificate and report shall be forwarded to Nodal Agency by technical agency involved;
- 4.5.2 For the purposes of clarity and easing access to relevant data, the communication includes an addendum containing the most relevant information related with the type-approved genset type or genset family;
- 4.5.3 The certificate shall be deemed to be valid for the model(s) included herein, unless explicitly withdrawn by separate written order by the Nodal Agency;
- 4.5.4 The Type Approval certificate for a genset family issued to the manufacturer shall be valid for the same model(s) manufactured at any other manufacturing plant of the same manufacturer. The Nodal Agency or technical agency concern with type approval may visit the new plant to verify adequacy of the infrastructure;

- 4.5.5 Validity of Type Approval Certificate issued by type approval authority shall remain valid for 'current' COP-year enabling sales of such type approved genset family for that duration;
- 4.5.6 Validity of Type Approval Certificate issued by type approval authority shall remain valid further as long as following conditions are met:
- i) Till the genset specifications change as mentioned in Annexure 1 and modification related clauses described in clause 4.6 below;
 - ii) Till the further amendments to the notification;
 - iii) Till COP is not missed / Till COP procedure compliance per clause 5 is obtained within prescribed timeframe as listed in clause 5.3.10.
- 4.5.7 In case manufacturer has not sold gensets in two subsequent COP-year period after immediate type approval and has done appropriate 'Zero volume' declaration seeking COP exemption to nodal agency, and for resuming sale for third year of such genset family, manufacture to conduct COP test before making any sell or a new fresh type approval application and subsequent process needs to be carried out. Refer clause 5.5 for COP certification.

4.6 Modification and Extensions of approved type

- 4.6.1. If genset type or genset family is type approved and valid, manufacturer may approach type approval certificate issuing technical agency for modifications pertaining to parent or any genset type in the certified genset emissions family. Such modifications shall be ascertained by manufacturer utilizing guidelines described in clause 4.6.5
- 4.6.2. Manufacturer shall submit technical document in line with type approval procedure prescribed in this Regulation;
- 4.6.3. Subjected to scrutiny of manufacture's application, technical agency shall approve or seek more data pertaining but not limited to genset architecture, parameters, similarity with existing genset type from emissions and performance perspective along with evidences. Decision of technical agency will remain finally binding for allowing such amendments to existing type approval certificate of a genset family through extension(s) vs asking manufacturer to type approve as new genset family or new genset type;
- 4.6.4. Technical agency retains all rights to ask manufacture to demonstrate modified genset type for emissions conformity through applicable type approval test procedures. Submission of manufacturer run emissions data with valid test facility and procedure followed is mandatory where changes are directly or indirectly pertaining to emission affecting components, genset and after treatment system control algorithms and genset performance specifications.
- 4.6.5. Following generic rules may be utilized as example for extensions of type approval certificate:
- 4.6.5.1. **No emission test requirements necessary:**
- (a) change to part numbers declared through type approval documentation that is not emission affecting;
 - (b) part number change of emission affecting component that is just an administrative change supported with due declarations (proto to production part number change as an example);
- 4.6.5.2. **Emission test compliance required:**
- (a) performance or specification or source change of a component declared through type approval documentation that is emissions affecting. This applies to any such component in genset and after treatment system including software;
 - (b) emissions strategy changes such as but not limited to fuelling timing, fuelling qty,
 - (c) addition of alternate source component that is emission affecting with or without part number change;

Changes as mentioned in above clause 4.6.5.1 and 4.6.5.2 may be verified during COP and not mandatorily confirmed by additional if requested by manufacturer. However, final decision will be with Test Agency.

- 4.6.5.3. In the event of an extension the Test Agency shall establish an updated communication denoted by an extension number that shall be incremental in accordance with the number of successive extensions previously granted. That communication shall clearly show the reason for the extension and the date of extension.

4.7. Type Approval Process Flow-chart

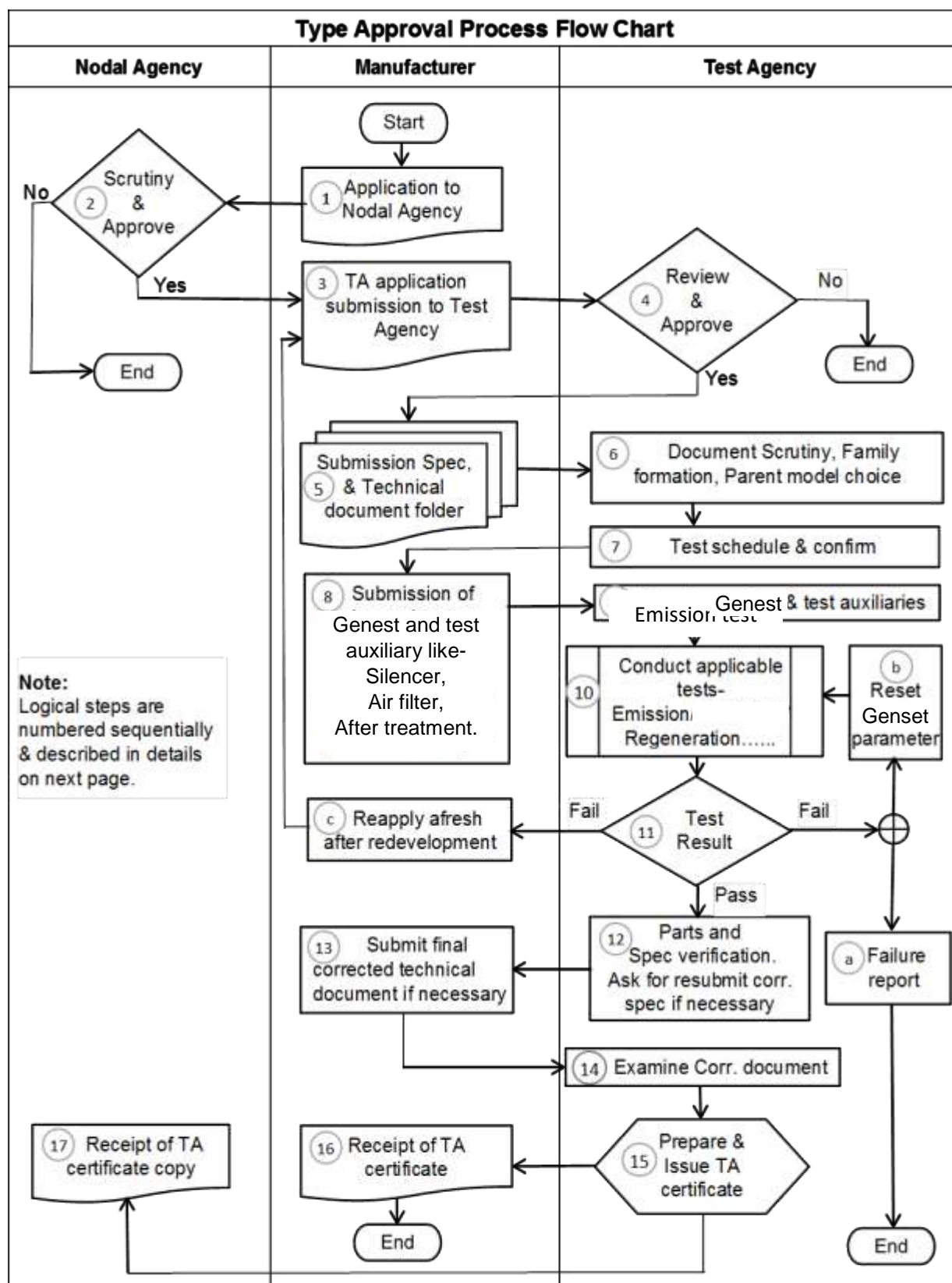

Following are the logical steps for the type approval process flow chart described in brief stepwise

1. Application to nodal agency (CPCB) in the form of affidavit seeking permission for type approval of Genset family through submission provided as draft specimen in Appendix 1.
2. Upon written approval of nodal agency to manufacturer and chosen technical agency; (*This could be decision making node with "Yes" / "No" loop*)
3. Submit type approval certification application to chosen test agency. Based on provisions such application can be written or online through their secured portal;
4. Obtain technical agency approval (*This could be decision making node with "Yes" / "No" loop with NO means, provide additional data*)
5. Upon agencies application scrutiny and negotiations, submit detailed technical documentation as per requirements described in Annexure 1;
6. Obtain documentation approval from technical agency, family formation, choice of parent genset, provide additional data
7. Obtain test plan/schedule from technical agency
8. Upon approval from technical agency plan for providing genset test auxiliaries like -Silencer, air filter, after treatment systems.
9. Upon receipt of genset along with auxiliary technical agency examine the adaptability in test cell, make necessary modification in exhaust line, mounts, etc, if required.
10. Conduct applicable tests-
Conduct emissions test to qualify (*This could be decision making node with "Pass" / "Fail" loop. "Fail" means, a) current TA application is closed out with failure report b) adjust. reset genset parameter for retest or c) further manufacturer may re-apply afresh after redevelopment*)
11. Review of all test results with manufactures and decision about compliance, in case of failure manufacture have three options to proceed a, b, & c, act accordingly.
12. Technical agency carries out part verification of critical genset components and take final review of technical document and ask manufacture to resubmit if necessary
13. Manufacture submit the corrected technical document if found necessary
14. Examine corrected document submitted in line with the requirement
15. Technical agency prepares technical report based on tests;
16. Technical agency issues type approval certificate to manufacturer;
17. Technical agency forwards a copy of type approval certificate to nodal agency

End

Appendix – 1

Application to Nodal Agency. Specimen for Submission of Affidavit & Profile details of manufacturer

Part - A

NOTARISED AFFIDAVIT ON NON-JUDICIAL STAMP PAPER

[To be submitted to the Nodal Agency by a supplier approaching for the first time for TA]

I,, Chairman / President / Managing Director / Partner / CEO / COO / Proprietor of M/s, having Registered Office at engaged in manufacturing / import of Portable Generator sets with manufacturing facilities / ware house at:

iii)

iv)

am authorized to swear this affidavit for and on behalf of the above named Company. I do hereby solemnly affirm and declare as under:

1. That the deponent is well conversant with the facts and competent to swear this affidavit.
2. That the deponent declares that M/s are manufacturer / importer of Portable generator sets in the brand name

iii)

iv)

(Strike out if not applicable)

3. That the deponent declares that M/s are importer of Portable generator sets from M/s i) (ii) M/s (Complete address)
(Strike out if not applicable)

4. That the deponent declares that M/s will obtain Type Approval / Conformity of Production verification only from (Name of the Certification Agency) and will not approach any other Certification Agency for Type Approval / Conformity of Production verification for any of their portable generator sets models, without prior permission from the nodal agency.

5. That the deponent declares that none of the Chairman, Managing Director, Partner, Director, Proprietor, Board Member in M/s has been involved with a Company / Firm which has manufactured and sold non-compliant portable genset.

6. That the deponent declares that M/s will manufacture / import and sell only compliant Portable generator sets

(Name & signature with Co. stamp)

(DEPONENT)

VERIFICATION

Verified at on thisof20..... that the contents of the above affidavit are true and correct to the best of my knowledge and belief and nothing has been concealed therein.

Place:

Date.....

(Name & Signature with Co. Seal)
(DEPONENT)

Part - B

FORMAT FOR SUBMISSION OF PROFILE AND DETAILS OF THE SUPPLIER

A. Company details

- Name of the Company
- Type of Company: Proprietor / Partnership / Private Ltd / Public Ltd
- Name of the Proprietor / Partners / Directors (submit relevant documents)
- Importer / manufacturer
- Registered Office Address with phone number
- Contact Address with phone number, fax number, email etc.
- Name and designation of the authorized person for submission of documents and to deal with the certification agency
- Plant addresses and contact details, in case of manufacturer
- Ware house address, in case of importer (This cannot be changed without prior intimation to Nodal Agency and Certification Agency)
- Name of the company from whom to import and its contact details, in case of importer
- Plant details, from where to import
- Authenticated Copies of following documents to be submitted
 - ix) Manufacturing License from Directorate of Industries / Department of Industry (in case of Manufacturer), IEC Code (in case of importer)
 - x) VAT and CST/GST Registration
 - xi) Excise Registration, in case of manufacturer
 - xii) Consent from State Pollution Control Board/ Pollution Committee
- No. of employees
- Engineers (if any)
- Last year Turn-over
- Any other business

B. Details of Genset (Proposed) manufactured / assembled / imported

Sr No	Model Names	Nos. produced /imported in current year	Nos. expected to be produced / imported in the next year
a			
b			
c			
d			

C. Details of Infrastructure

D. Land: Owned / Rented

Area (m2):

E. Covered Area

F. Machinery for manufacture

- e)
- f)
- g)
- h)

G. Testing facility equipment's

- d) Load bank type and capacity
- e) Measuring Instruments
- f) Any other

H. Quality Control

- 6. Quality Control In charge
- 7. Quality Procedure:
ISO Certified since when (Enclose a Copy of Operating Procedure)
- 8. Pre-delivery Inspection Procedure on Gensets (including records maintained)
- 9. System of serial numbering and marking on Genset and their sub-systems – e.g. all Enclosures, etc.)
- 10. Any other

Date:

Place:

SIGNATURE OF THE
(Chairman /President / Managing Director
/ Partner / CEO / COO / Proprietor)

SEAL OF THE COMPANY

---End---

5 Conformity of Production Administrative Procedure

5.1 General

- 5.1.1. Conformity of Production (COP) compliance is designed to ensure manufacture's compliance and control towards a type approved genset family to statistically ensure genset sold under such emission certification does meet required emissions.
- 5.1.2. COP process compliance also ensures type approval certificate validity and hence right to produce and sale genset by a manufacturer owing such type approval certification for the next COP-year. Such provision is administratively provided by issuing Conformity of Production Certificate;
- 5.1.3. Each manufacture shall subject it's genset model range to the verification of COP, every year. For this, the year shall mean the period from 1st July of the calendar year to 30th June of the succeeding calendar year;

5.2 Verification of Conformity of Production (COP)

5.2.1 COP of domestically manufactured genset families

- 5.2.1.1 the verification of COP shall be done once in a COP-year as per plan described in following 'Table 1'

Table 1

Number of families to be tested for verification of COP for domestic manufactures

Total number of families of the domestic manufacturer	Total number of families to be tested per year
1 – 3	1
4 – 7	2
8 – 11	3
12 – 15	4
>15	5

5.2.2 COP of imported genset families

Imported genset shall be subjected to the verification of COP once for every 1000 units per family imported or once a year, whichever is earlier.

5.3. Sample size, Decision and Other Criteria for verification of COP

- 5.3.1 In case of genset defined in clauses 5.2.1.and 5.2.2. above, testing shall be done on sample(s) randomly selected by certification agency from the production line / import warehouse.
- 5.3.2 Minimum quantity of 25 numbers or one day's average production volume of the genset model selected by technical agency, whichever is more shall be made available for random selection. The limit shall be minimum 10 units in case of import. Averaging of production volume will be based on total working days at time of selection.
- 5.3.3 If the manufacturer is not of Indian origin, the manufacturer should establish a base office in India, which is to be declared in the initial application submitted to Nodal Agency as per Appendix 1 This base office will be responsible for Type Approval and COP compliance;
- 5.3.4 The manufacturer shall request the certification agency when they would like to make random selection of genset(s) and to seek their schedule/availability for completing the COP test;

- 5.3.5 COP verification shall be carried out for each plant of the domestic manufacturer. For imported genset, the COP testing shall be carried out on the genset manufactured for each country of origin irrespective of genset family being same;
- 5.3.6 The certification agency shall intimate to the manufacturer the schedule (month) of sampling / testing. The manufacturer shall inform the production/ import plan for the month in which the technical agency wants to carry out the COP, to the technical agency. If the manufacturer has a problem due to particular reasons such as the particular model is not likely to be scheduled for production / import at that time, or enough number of gensets may not be available for random selection; the time schedule may be modified based on mutual convenience of the manufacturer and the technical agency;
- 5.3.7 The manufacturer shall complete all COP activities (such as random selection, initial running-in, emission testing and documentation) at least one month before the end of COP-year. The COP certificate shall not be issued in case of non-adherence to above schedule unless such schedule attainment is due to unavoidable reasons such as but not limited to test facility downtime, extended COP process encountered.
- 5.3.8 Following 'Table 2' gives the deadlines for the respective COP-year for the COP activities. However, manufacturer can take early action on each activity to ensure compliance.

Table 2

Sr. No	Activity Description	Last Date
1	Submission of production / import plan / actual details to technical agency	1 st March
2	Random Selection	1 st April
3	Submission of genset and subsequent testing (Including extended COP if any)	31 st May
4	Completion of documentation and COP Certificate issuance	30 th June

However, the above schedule shall be preponed, subjected to mutual agreement between test agency and manufacturer keeping in view financial year closing and other reasonable cause.

- 5.3.9 The manufacturer shall inform the technical agency regarding the stoppage of production of a specific model, in case this has not been anticipated at the start of the COP period. This shall be intimated well in advance so that COP selection of the genset can be completed by the technical agency before stoppage of production. Manufacture is held accountable for ensuring COP is conducted and samples are made available per requirements of this Regulation;
- 5.3.10 The manufacturer shall provide all the assistance required by the technical agency for completing the tests;
- 5.3.11 The latest updated technical specifications, procedure of pre-delivery inspection (PDI), running-in and servicing of the genset, shall also be submitted before the genset selection, if there have been revisions after the previous COP / type approval;
- 5.3.12 Pre-delivery inspection as per owner's instruction manual / service manual will be carried out by the manufacturer as per procedure declared at the time of type approval and as amended and intimated to concern technical agency from time to time for the selected genset(s), under the control of technical agency;
- 5.3.13 The running-in of the genset(s) shall be carried out as per the manufacture's recommendation submitted during the type approval and as amended and intimated to the concern technical agency from time to time, for genset(s) under control of the technical agency. Running-in may also be carried out at genset manufacture's place under the control of technical agency provided adequate facilities are available. After such running-in procedure, manufacture will be permitted to carry out all the adjustments recommended in their owner's / service manual and as amended and intimated the concern technical agency from time to time published with technical agency, under the control of the technical agency;

- 5.3.14 In case of failure of any major component during the running-in or testing, the technical agency may permit to replace component only once; which has failed and which does not affect the performance and emission of the genset. Such decision is entirely with technical agency. In case of failure of emission affecting component, random selection of genset at manufacture's plant or warehouse shall be done afresh. If for such randomly selected genset (second time) or a replaced component fails again, it shall be reported to the nodal agency by the concern technical agency and agency shall await instructions from the nodal agency for further action;
- 5.3.15 The manufacture shall submit the randomly selected genset(s) to technical agency within four weeks (8 weeks in case of import subjected to last date as mentioned in clause 5.3.8. – Table 2) of completion of running-in for emission compliance test;
- 5.3.16 The technical agency should endeavor to complete the required testing of selected genset(s) within four weeks after submission of genset(s);
- 5.3.17 The testing shall be done as per applicable procedures and specifications described in Annexure 4

5.3.18 Sampling plan for COP

- 5.3.18.1 The number of samples to be tested shall be minimum as necessary, as given in Table 3 to arrive at a decision on whether the production unit complies with applicable emission limits;
- 5.3.18.2 A sample said to have failed for particular criteria pollutant if the test result of the sample for the criteria pollutant exceeds emission limit;
- 5.3.18.3 The production units of all models in the family shall be deemed to comply with the emission limits if the number of failed samples as defined in clause 5.3.18.2 above for each criteria pollutant is less than or equal to the pass decision number appropriate to the cumulative number of samples tested for that criteria pollutant as given in Table 3;
- 5.3.18.4 The production units of all models in the family shall be deemed to be non-complying with the emission limits if the number of failed samples as defined in clause 5.3.18.2 above for each criteria pollutant is more than or equal to the fail decision number appropriate to the cumulative number of samples tested as given in Table 3;

Table 3
Sampling plan and decision criteria for the verification of COP

Cumulative Samples	Pass decision	Fail decision	Cumulative Samples	Pass decision	Fail decision
	No. of failure			No. of failure	
1	(^a)	(^b)	16	6	11
2	(^a)	(^b)	17	7	12
3	(^a)	(^b)	18	7	12
4	0	(^b)	19	8	13
5	0	(^b)	20	8	13
6	1	6	21	9	14
7	1	7	22	10	14
8	2	7	23	10	15
9	2	8	24	11	15
10	3	8	25	11	16
11	3	8	26	12	16
12	4	9	27	12	17
13	5	10	28	13	17
14	5	10	29	14	17

15	6	11		30	16	17
<p>(^a) : Series not able to pass at this stage (^b) : Series not able to fail at this stage Note: ix) COP compliance or non-compliance decision is on the basis of number of failures within the respective cumulative samples tested. x) During successive testing, the decision which reached first is the final. xi) Minimum 4 samples are required to test to reach pass decision xii) Minimum 6 samples are required to test to reach fail decision</p>						

5.3.18.5 Once a compliance or non-compliance decision is made for a particular criteria pollutant, the result of testing of subsequent samples for that criteria pollutant shall not influence the decision;

5.3.19 Gross Power failure during COP

5.3.19.1 For verifying the conformity of production, if anyone selected genset does not meet the gross power and rated speed limit as applicable, another four gensets will be taken from the series at random and be tested as per this part. All these selected gensets shall meet the limit values specified. One genset shall be subjected to the emission test for the conformance of production.

5.3.19.2 If further same failure is noted in any of the additionally selected samples of clause 5.3.19.1 the production shall be considered as non-compliance and the provision of clause 5.8, shall be put into effect.

5.4 Certificate of Conformity of Production (COP) and It's Validity

5.4.1 After verification for COP, the certification agency shall issue a COP verification report to the manufacturer within one month of the date of testing completion, indicating compliance or non-compliance. In case of compliance, the technical agency shall issue a COP certificate to the manufacturer as per format prescribed in Annexure 2 along with report. At the end of COP year, details of COP & the Copies of certificate as well as report shall also be forwarded to the Nodal Agency;

5.4.2 Certificate of conformity of production is required to commence the production and sale of portable generator sets in immediately next COP-year. Validity of current COP certificate shall be till successful compliance of COP test in next COP-year

5.4.3 The COP certificate will be issued at the end once all the numbers of genset samples demanded as per the production plan submitted become tested successfully. Intermediate COP certificate i.e at each sample tested shall not be issued, However the test data report will be issued at every test sample.

5.5 COP Discontinuity

5.5.1 If there is no production or import of model(s) of a particular genset family for two consecutive years immediately after obtaining type approval or immediately after obtaining COP certificate, the type approval certificate for that particular genset family becomes invalid. In case the manufacturer wants to manufacture or import genset model(s) of such particular genset family, then the manufacture shall approach Nodal Agency and technical agency to obtain a new Type Approval certificate afresh following stated procedure;

5.5.2 If there is no production or import of model(s) of a particular genset family for two consecutive years immediately after obtaining type approval and if the COP test is requested for the third year, then the supplier shall approach Nodal Agency to obtain approval for the extension of validity of

Type Approval. This is applicable only for a new manufacturer and in case no genset(s) sale has happened post type approval;

5.6 Exemption from COP

In the following cases, genset family(ies) shall be exempted from COP process.

- 5.6.1 If Type Approval obtained in the last quarter (Apr–Jun) of COP year. This clause is not applicable to the manufacturer as mentioned in clause 4.4.4.
- 5.6.2 In case of no production or import, the manufacturer shall submit a declaration to technical agency and Nodal Agency for 'No production or import' of a particular family models for every COP-year;
- 5.6.3 The COP test shall be conducted by technical agency for the next COP-year, upon receipt of declaration by the manufacturer that there was no production or import during current COP-year;
- 5.6.4 Declaration in this regard should be submitted before end of third quarter of the current COP-year; (i.e 31st March). In case, if produced after 31st March, COP is applicable.
- 5.6.5 Any genset manufactured for purpose of export outside India. COP exemption shall apply for such volumes and COP test exemption shall apply if all such genset(s) produced are exported;
- 5.6.6 Any domestically manufactured genset intended for the purpose of sample (Maximum number of 4 units per genset family) only and not for sale in India;
- 5.6.7 Any genset imported for the purpose of sample testing, bench making and not intended for any commercial sale (Maximum number of 4 units per year);
- 5.6.8 Any genset imported for the round robin or laboratory correlation tests. Such genset shall be exported back within 12 months from the date of import; or it should be scrapped and a scrap certificate shall be provided.
- 5.6.9 For obtaining exemptions regarding clauses 5.6.2, 5.6.6, 5.6.7 and 5.6.8, the manufacturer shall obtain written approval from Nodal Agency. Nodal agency should endeavor to respond within 4 week after the receipt of application.
- 5.6.10 COP exemption shall be maximum up to three consecutive COP year, to resume sell from fourth year a fresh type approval shall to be conducted.
- 5.6.11 After obtaining exemption as per 5.6.2, manufacturer shall first conduct COP before making any sell.

5.7 Production Definitely Discontinued

- 5.7.1 If manufacturer decides to discontinue production / withdraw type approval certificate of a specific genset family or multiple families from a specific plant or all plants, the manufacturer shall so inform to Test Agency involved in type approvals and COP compliance at least three month before the stoppage of production;
- 5.7.2 In such case, the manufacturer shall ensure COP compliance for the genset family(ies) from every manufacturing plant before the production of the genset family(ies) is discontinued following COP compliance process described in clauses 5 of this Regulation;
- 5.7.3 Upon receiving the relevant communication, the Test Agency shall inform the manufacturer the acceptance of the communication and provide an acceptance letter.

5.8 Consequences of non compliance

- 5.8.1 If the COP verification report of the technical agency for a model family indicates non-compliance, the manufacturer must stop manufacturing with immediate effect;

- 5.8.2 Further, the manufacturer must analyze the reasons for non-compliance, plan to take corrective actions in design, production line and units already produced and submit a report to the nodal agency with a copy to concern technical agency within four weeks of the receipt of the COP verification report;
- 5.8.3 If the manufacturer is unable to diagnose the reasons for non-compliance within stipulated time, this shall be clearly stated in the report;
- 5.8.4 Based on the diagnostics and corrective action plan submitted by the manufacturer, the Nodal Agency in consultation with technical agency and if both decide to, in consultation with standing committee, may take any of the following actions:
- 5.8.4.1 Allow continuation of production or import of all models in the family if it is satisfied with the corrective actions planned or taken by the manufacturer and ability to meet emission norms;
- 5.8.4.2 Allow continuation of production or import of some or all other models of the genset family if it determines that the reasons for non-conformance of the tested model are not relevant to these models; with or without additional verification of COP in due course;
- 5.8.4.3 Stop production or import of some or all other models of the genset family till compliance is demonstrated by the supplier, through a re-verification of COP. In case of imported model(s), the non-compliant genset should be sent back to the original destination;
- 5.8.5 The manufacturer shall be given an opportunity to explain its views before taking final decision;
- 5.8.6 It is responsibility of the manufacturer to ensure at his cost that the modifications are carried out such as field retro fitment campaigns within period specified by the Nodal Agency on all products produced as well as sold / dispatched in the period between the dates from which the COP became due and re-verification of COP or as decided by the Nodal Agency, in consultation with standing committee;
- 5.8.7 Nodal Agency with help from Technical agency shall audits compliance in field on random basis for corrections done and issues closure letter to manufacturer
- 5.8.8 Further, to avoid such non-compliances again in future, additional precautionary measures shall be initiated to strengthen the process after re-certification & resuming the production with new modified spec;

5.9 COP Process Flow Chart

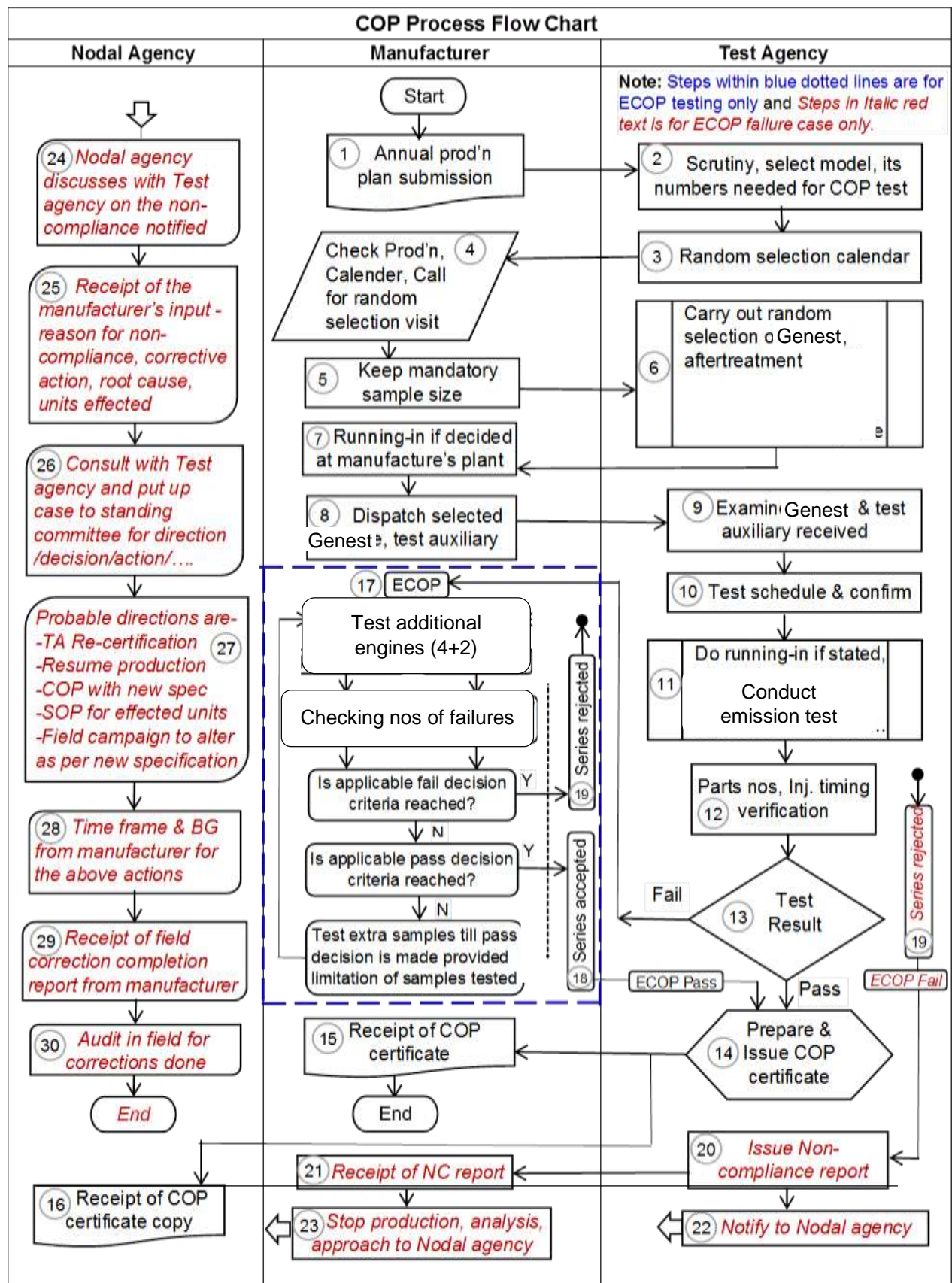

Following are the logical steps for the COP process flow chart described in brief stepwise-

COP cycle shall end with either -

- I. COP compliance with regular sample testing (Steps 1-16)
- II. COP compliance with extended samples testing (.... Steps 17-18)
- III. COP non-compliance after extended testing (.... Steps 19-30)

CASE I:

1. Manufacturer with valid Type Approval and COP certification submits annual estimated production/import volume data to technical agency involved in the format provided within two months of start of new COP-year.
2. Technical agency, based on the production/import volumes, communicates to manufacturer, the genset type chosen and the number of samples needed for COP compliance test for all genset families of that manufacturer within one month of submission of above production volume data;
3. Technical agency also communicates to the manufacturer plan for COP genset random selection based on manufacture's input above;
4. Manufacturer coordinates adhering to technical agency provided or negotiated plan and coordinates for genset random selection at manufacturing plants/warehouses/sales points for imported genset as the case may be.
5. At the point of selection as mentioned in Sr 4, manufacturer provides with minimum required sample size for random selection;
6. Technical agency representative carries out random selection and does note emission critical component part and serial numbers. Provides with appropriate seal for avoiding tampering of assembly parameters further;
Technical agency representative randomly selects after treatment system if applicable;
7. Decision, if running-in is carried out at manufacturer's location or technical agency location;
If running-in is agreed to be carried out at manufacture's facility, running-in shall be started in presence of technical agency representative.
8. Genset along with arranged after treatment shall be transported to technical agency test location;
9. Upon receipt of genset along with auxiliaries, technical agency examines the adaptability in test cell, make necessary modification in exhaust line, mounts, etc, if required.
10. Technical agency communicates the test schedule to manufacture for his witness
11. Technical agency carries out genset qualification and emissions test per applicable procedure and shares results with manufacturer;
12. Technical agency carries out critical component type/part numbers, injection timing verification and match with type approved document, in case any change noted, manufacturer to provide the declaration in this regard, till time COP certificate will be on hold.
13. Review of test result & decision on compliance;
14. If COP compliance is obtained, Technical agency prepared the compliance certificate within 4 weeks from the date of testing. Genset & after treatment, test auxiliary is returned to the manufacturer;
15. Technical agency issue compliance certificate to manufacturer
16. Technical agency forwards a copy of compliance certificate to Nodal agency

CASE II:

17. **ECOP:** If non-compliance observed after testing (at Stage No 13), process begins from extended random selection of genset(s) as per preferred options prescribed in clause 5.3.18.
 - 17.1 For establishing the compliance minimum 4 samples are mandatory to be tested and all 4 samples should pass.
 - 17.2 If some samples failed, the additional new more samples, are required to be tested, the numbers depend on the number of samples failed earlier,
 - 17.3 Initially test 2 more new gensets
 - 17.4 In the cumulative samples (4-originally tested + 2 new), note the numbers of failed samples
 - a) According to the appropriate clause does the number of failed samples agree with the criteria for failing the series
 - b) According to the appropriate clause does the number of failed samples agree with the criteria for passing the series
 - 17.5 If, answers of a & b are NO, then; continue the testing on additional samples till pass decision is made provided limitation of samples tested as applicable (30 numbers)
18. If during testing if the pass decision criteria is reached, the series is deemed to be compliance and COP certificate is issued (then continue from Stage14-16)

CASE III:

19. If during testing if the fail decision criteria is reached, the series is deemed to be non-compliance; Or if Manufacturer opts to declare non-compliance without availing total number of samples allowed to be tested, the series is deemed to be non-compliance
20. Technical agency prepares the COP failure report
21. Technical agency issue COP failure report to manufacturer
22. Technical agency informs nodal agency about COP non-compliance of said genset family
23. Manufacturer stops production or import of the said non-compliant genset family;
Manufacturer informs nodal agency about non-conformity, stoppage of production and dispatch and their plan for failure investigation within 4 weeks of receipt of COP verification report or COP failure intimation
24. Nodal agency discusses with test agency in details on the non-compliance notified.
25. Nodal agency replies to the manufacturer about their inputs on timelines by which compliance shall be obtained as well as failure root cause and corrective action plan submission. Nodal agency also informs about any financial penalty or assurance required from the manufacturer;
Manufacturer submits root cause analysis and corrective action plans to nodal agency in consultation with technical agency;
26. Nodal agency in consultation with technical agency reviews manufacture's submissions and decides if such case shall be put forth for standing committee review and guidance if found necessary depending upon the severity of the failure.
If decided to represent at standing committee, nodal agency brings this issue to standing committee and allows manufacture to represent their submissions. If standing committee agrees / approves manufacturer's submission and plan then;
27. Nodal Agency can also decide on their own & shall take following decision:
 - 27.1 Gives written permission to technical agency to proceed with re-verification of COP with improvements implemented by manufacturer and also type approval re-certification as the case may be.

- 27.2 Manufacturer offers genset sample and technical documentation to technical agency and complies with COP;
 - 27.3 Technical agency issues compliance certificate or type approval certificate if newly approved as an option;
 - 27.4 Manufacture begins production after obtaining new Type Approval or COP compliance certificate;
 - 27.5 Manufacturer completes corrective actions on genset dispatched during period of COP and COP failure date;
- 28. Manufacturer complies with 'financial assurance related' documents asked by Nodal Agency;
 - 29. Manufacturer submits corrective action / campaign report with adequate evidences to Nodal Agency
 - 30. Nodal Agency with help from Technical agency audits compliance in field for corrections done and issues closure letter to manufacturer;

End

ANNEXURE – 1

Information document-Template for submission of portable genset technical specification

1.0	NAME & ADDRESS OF THE GENSET MANUFACTURER / IMPORTER – Type approval certificate holder.	
2.0	AUTHORISED CONTACT PERSON DETAILS- Name, Designation, Email, Contact number	
2.1	GENSET CATEGORY – Indigenous or Imported	
2.2	ADDRESS OF THE MANUFACTURING PLANT/S	
3.0	PRODUCT CATEGORY	
4.0	MODEL NAME / BRAND NAME	
5.0	GENSET CANOPY TYPE: HALF /FULL	
6.0	CLASS OF THE GENSET AS SPECIFIED IN THE REGULATION	
7.0	MODEL FAMILY DESIGNATION ASSIGNED TO THE MODEL	
8.0	GENSET OUTPUT SPECIFICATIONS	
8.1	No. of phases	
8.2	Rated voltage (V)	
8.3	Rated current (A)	
8.4	Rated frequency (Hz)	
8.5	Overall efficiency of the alternator % (Submit relevant document)	
8.6	Max. output declared by manufacturer with tolerance (VA)	
9.0	Alternator Make	
9.1	No. of Poles used	
10.0	PRODUCTION / IMPORT PLAN (SCHEDULE) AND ESTIMATED VOLUME PER ANNUM	
11.0	DESCRIPTION OF THE GENSET ENGINE	
11.1	Make	
11.2	Type	

11.3	Working principle, Four stroke / Two stroke	
11.4	Bore (mm)	
11.5	Stroke (mm)	
11.6	Number of cylinders	
11.7	Engine Displacement (cc)	
11.8	Compression ratio (with the tolerance)	
11.9	Max. power of the Engine (kW)@ rpm	
11.10	Drawings of combustion chamber and piston crown	
11.11	Minimum cross-sectional area of inlet and outlet ports (mm ²)	
12.0	COOLING SYSTEM	
12.1	Liquefied / air cooling Liquefied cooling: Max. temp. at Engine Outlet	
12.2	Engine Lub oil Temperature: Minimum: Maximum:	
12.3	Characteristics of air-cooling system	
12.4	Blower: Characteristics of make(s) and type (s)	
12.5	Air ducting (standard production)	
12.6	Temperature regulating system	
12.7	Intake system	
12.8	Intake manifold description	
12.9	Air filter: Make & Type	
12.10	Device for recycling crank-case gases: Description and diagrams	
13.0	ADDITIONAL ANTI-POLLUTION DEVICES	
13.1	Catalytic Converter	
	a) Make:	
	b) Type:	
	c) I.D:	
	d) Substrate Dimension:	
	e) Loading:	
	f) CPSI:	
13.2	Secondary air Injection system details	
	a) Make:	
	b) Type:	
	c) I.D:	

	c) Quantity of valve	
14.0	Fuel feed system	
	a) Make:	
	b) Type:	
	c) I.D:	
14.1	Carburetor Air screw settings (specify the tolerance)	
14.2	Jet size: a) Main Jet: b) Pilot jet:	
14.3	Carburetor Venturi Diameter (mm)	
14.4	Float-chamber level	
14.5	Mass of float in grams.	
14.6	Float needle	
14.7	Dimensions mixture duct	
14.8	Manual / automatic choke, closure setting	
14.9	Fuel Feed (By fuel injection/Carburation) including details of NG/LPG kit and Cylinder details to be specified: Gas Air mixer Make /Type: Gas Air mixer diameter: No. of holes: System description Working principle: intake manifold / direct injection / injection pre-chamber / swirl chamber	
14.10	Fuel Injection System:	
	a) Make	
	b) Type	
	c) I.D No.	
	d) Injection timing	
	e) Injection advance curve	
14.11	a) Injectors:	
	b) Make	
	c) Type	
	d) Opening pressure (specify tolerance)	
14.12	Governor /ECU/Controller	
	a) Make	
	b) Type, Mechanical /Electronic/Hydraulic	
	c) ID. No.	
	d) Max. speed without load / min	

	e) Idle speed	
14.13	Exhaust Gas Recirculation (EGR) System	
	a) Make	
	b) Type (Internal/External/cooled/uncooled/progressive OFF/Electrical/Vacuum based/Other) ON	
	c) ID No.	
14.14	Other Pollution Control Device	
	a) Make	
	b) Type (Give Complete Details of the system with necessary drawings)	
	c) ID No	
14.15	Cold start device	
	a) Make	
	b) Type	
	c) System description	
14.16	Starting aid	
	a) Make	
	b) Type	
	c) System description	
15.0	VALVE TIMING OR EQUIVALENT DATA	
	Maximum lift of inlet valve, (mm) Maximum lift of Exhaust Valve, (mm) Angles of Valves (w.r.t. top dead center) a) Inlet valve opening angle (IVO) b) Inlet Valve Closing angle (IVC) c) Exhaust valve opening angle (EVO) d) Exhaust valve Closing angle (EVC)	
16.0	Description of reed valves if any (with dimensional drawing)	
16.1	Description (with dimensional drawing) of inlet ports, scavenging and exhaust, with corresponding timing diagram	
17.0	IGNITION	
	a) Ignition system	
	b) Make	
	c) Type	
	d) Ignition timing (specify the tolerance)	

	e) Contact point gap and dwell-angle (specify the tolerance)	
	f) Spark plug – Make Type Gap setting Spark seat temperature at max. output	
18.0	EXHAUST SYSTEM	
	Description and diagrams	
	Specify the Back Pressure (kPa) at rated power	
19.0	SETTING AND LIMIT DECLARED BY THE MANUFACTURER	
	Lubricating Oil Temperatures Deg C Minimum / Maximum	
	Please specify if any	
	Please specify if any	
19.0	LUBRICATION SYSTEM	
	a) Description of systems	
	b) Position of lubricant reservoir	
	c) Feed system (pump, injection into intake, mixing with fuel, etc.)	
	d) Lubricating pump	
	e) Make	
	f) Type	
	g) Lub oil mixed with fuel	
	h) Oil Percentage in fuel	
	i) Lubricant Used	
	j) Make	
	k) Type	
20.0	ADDITIONAL INFORMATION ON TEST CONDITIONS	
	Please specify if any	
	Please specify if any	
21.0	Ignition coil	
	a) Make	
	b) Type	
22.0	Ignition condenser	
	a) Make	
	b) Type	
23.0	Radio interference suppression equipment	

	a) Make	
	b) Type	
24.0	Details of LPG / CNG Kit	
24.1	a) Kit Manufacturer Name	
	b) Kit Manufacturer Address	
24.2	Cylinders	
	a) No. Of Cylinders	
	b) Type of Cylinders	
	c) Cylinder Sr.No	
	d) Make	
	e) Water Capacity (litres)	
	f) Working Pressure (kg/cm ²)	
	g) Approval reference of DOE	
24.3	Multifunctional valve	
	a) Make	
	b) ID	
	c) Sr. No	
24.4	Fuel Line	
	a) High pressure pipe diameter (ID/OD)	
	b) Low pressure pipe diameter (ID/OD)	
24.5	Shut Off Valve (Solenoid Valves)	
	a) Make	
	b) Type	
	c) Operation Voltage	
24.6	Fuel selection switch	
	a) Make	
	b) Type	
24.7	Regulator	
	a) Make	
	b) Type	
24.9	Gas-Air Mixer/Injector	
	a) Make	
	b) Type	
25.0	Attachments to be Enclosed	
25.1	Combustion Chamber (Piston Crown) Drawing	

25.2	Valve Timing Diagram
25.3	Oxidation Catalyst Layout and drawing along with specifications
25.4	Air Intake system layout (from air-filter to intake manifold)
25.5	Exhaust system layout which includes catalyst position/location
25.6	Others. Please specify

Note:-

1. Strike out whichever is not applicable
2. In addition to the names of the manufacturers of items mentioned above, the manufacturers shall inform the test agency that carries out the type approval, the names of new alternate manufacturers for these items as and when they are being introduced.

Test Agency:	Manufacturer	Document No. (indicating also revision status)
Signature	Signature	
Name	Name	
Designation	Designation	Revision date
Date	Date	Sheet No.

ANNEXURE – 2

Specimen Copy for Type Approval and COP certificate

a) Type Approval Certificate Format

Type Approval Certificate No: _____

Date: dd-mm-yyyy

Cert	Rep.	Spec.	Drg.	Total

CERTIFICATE OF TYPE APPROVAL

for

COMPLIANCE TO MASS EMISSION NORMS FOR

**Gasoline or Dedicated NG or LPG or Bio-CNG or BI Fuel- Gasoline and NG/LPG/Bio-CNG fuel run
PORTABLE GENERATOR SETS**

1. In order to establish compliance to the provisions of **mass emission limits**, applicable as on date, documental verification /necessary testing was carried out on the following Portable **Generator set model(s)**, submitted by the manufacture/importer

Portable Generator Set Supplier: _____		Portable Generator Set Manufacturer: _____	Test Report Reference: _____	
Generator Set Model(s)/Brand Name		Type	Family	Category
Parent	Variants			

2. It is certified that the above mentioned Generator Set model(s) comply with the emission limits applicable for Gasoline, dedicated NG or LPG or Bio-CNG or BI fuel- gasoline and NG/LPG/Bio-CNG fuel run genset, as prescribed under the following rules notified by Ministry of Environment & Forest and Climate Change, Govt. of India:

Notification	Date	Rule.No	Description	Date Of Compliance of Emission Norms
G.S.R. 804(E)	GSR 804(E.) dated 3- Nov-2022	Rule ,1986, in schedule I, Serial number 88 and 95	Mass Emission Norms for Gasoline, Dedicated NG or LPG or Bio-CNG, BI fuel- Gasoline and NG/LPG/Bio- CNG fuel	

3. Validity of the Certificate:

This Type Approval Certificate is valid till	1.Further amendment to notification No. GSR 804(E.) dated 3-Nov-2022
	2.No change in technical specification of the Generator Set specified
	3.Explicitly the Type Approval Certificate withdrawn by the Generator Set manufacturer/Supplier /Assembler/Importer

4. Conformity of Production (COP) requirements:

COP test shall be carried out once in a year (between the period 1st July of Calendar year to 30st June of succeeding calendar year

Note: Refer overleaf for disclaimer.

Authorized Signatory
(Head)
Certification Laboratory

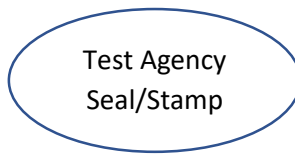

Authorized Signatory
(Head)
Certification Body

Place of Issue: dd-mm-yyyy

b) COP Certificate Format

COP Certificate No. _____

Date: dd-mm-yyyy

Cert	Rep	Total

CERTIFICATE OF CONFORMITY OF PRODUCTION (COP) FOR THE YEAR yy-yy

For

COMPLIANCE TO MASS EMISSION NORMS FOR

**Gasoline or Dedicated NG or LPG or Bio-CNG or BI Fuel- Gasoline and NG/LPG/Bio-CNG fuel run
PORTABLE GENERATOR SETS**

Company Name: _____

1. Based on the verification of documents and trials conducted on portable genset model manufactured by and randomly selected from their (plant address____), It is certified that the portable genset model of families FXX complies with the provisions of Verification of the Conformity of Production (COP) as per para 5.0 of CPCB procedure (System & Procedure for Compliance to Emission Limits for Gasoline, dedicated NG or LPG or Bio-CNG, BI fuel- Gasoline and NG/LPG as per requirements of Rule 88 and 95 of Environment (Protection) Rule 1986, of GSR 804(E.) dated 3-Nov-2022 notified by Ministry of Environment, Forests and Climate Change Govt. of India.
2. This certificate covers the genset families and its models as listed in below table, declared by the manufacturer to have been produced / planned to be produced, during the stipulated period from 1st July to 30th June.

Sr. No.	Family	Model	Manufacturing Plant	Manufacturing Period	COP Year	Reference Type Approval Certificate No.

3. Validity of Certificate:

- a) This COP certificate is valid up to 30th Jun yyyy. Validity of this certificate is subjected to completion of next COP before 1st July yyyy for the production of portable genset model/s during the period 1st July to 30th Jun once.
- b) As confirmed by the manufacturer this COP certificate is issued for the planned production during the manufacturing period.

4. Disclaimer: Refer overleaf for disclaimer

Authorized Signatory
(Head)
Certification Laboratory

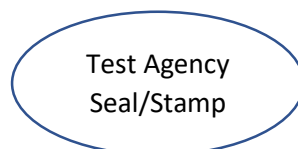

Authorized Signatory
(Head)
Certification Body

Enclosure: Test report No.: _____ **dated dd-mm-yyyy**

Place of Issue: dd-mm-yyyy

ANNEXURE – 3

Labelling Requirements

A3.1. The genset or the product must be affixed with a conformance label meeting the following requirements.

A3.1.1. General Requirement

- i. The label shall be durable and legible;
- j. The label shall be affixed on a part necessary for normal operation of the genset or the product and not normally requiring replacement during the life of the genset or the product;
- k. All the information mentioned in the conformance label must be in English language;

A3.1.2. Conformance Labelling Content Requirement

- q. Name of Genset manufacturer or product importer
- r. Manufacturing plant address from where Genset is manufacture
- s. Genset Model name;
- t. Rated maximum output of Genset in kVA
- u. Genset Unique Identification Number (Serial Number, etc.);
- v. Date of manufacturing and in case of import, date of import of Genset product; format in mm/yy shall be acceptable.
- w. Type Approval certificate number;
- x. Statement that 'this engine or product conforms to the Environment Protection Rule 1986;

Compliance name plate model

Manufacturer	<input type="text"/>		
Mfg. Plant	<input type="text"/>		
Genset Model	<input type="text"/>	Rated output (kVA)	<input type="text"/>
Genset Sr No	<input type="text"/>	Date of Mfg.	<input type="text"/>
Type Approval Cert. No.	<input type="text"/>		
This genset or product conforms to the Environment Protection Rule 1986			

ANNEXURE– 4

Test equipment, Test fuel, Test procedure & Test result calculation

1.0 Overview

The test facility to be used shall be of the certification agencies or any other facility approved by these certification agencies. The test Lab at Test Agency/ Engine Manufacturer Lab/ Third party Lab shall be accredited as per the requirement of ISO/IEC-17025 (NABL-National Accreditation Board for Testing and Calibration Laboratory) compliance for the related GSR/S&P/ISO-8178 Standards. The tests shall be carried out under the control of the certification agencies.

For portable genset, test shall be done on resistive load bank

2.0 Test Fuel

The reference fuel or commercially available fuel as prescribed by Govt. of India in CMVR document, Gasoline, or NG or LPG or Bio-CNG as applicable shall be used for testing. As per the choice of manufacturer, fuel spec reference or commercial may be used. As specified in this document no other fuel, other than stipulated by CPCB, shall be used to start and run the genset without consent from CPCB.

3.0 Test equipment

Test equipment & other relevant technical details to be used shall be as per following standards, except where it is mentioned, specifically, in this document.

ISO 8178 – 1 2017, 2020: Reciprocating internal combustion engines — Exhaust emission measurement — Part 1: Test-bed measurement systems of gaseous and particulate emission

4.0 Emission test cycle using resistive load bank

Emissions from the portable gensets powered by SI engine (up to 800 cc displacement) shall be tested using Resistive Load Bank as per following 3-mode test cycle. (Reference ISO 8178-Part-4)

Mode No.	Load current	Frequency	Weighting Factor
1	Maximum output declared by the manufacturer of the genset (tolerance $\pm 5\%$ for TA and $\pm 6\%$ for COP)	50 +1Hz	0.3
2	75% of Mode 1	50 +1Hz	0.5
3	50% of Mode 1	50 +1Hz	0.2

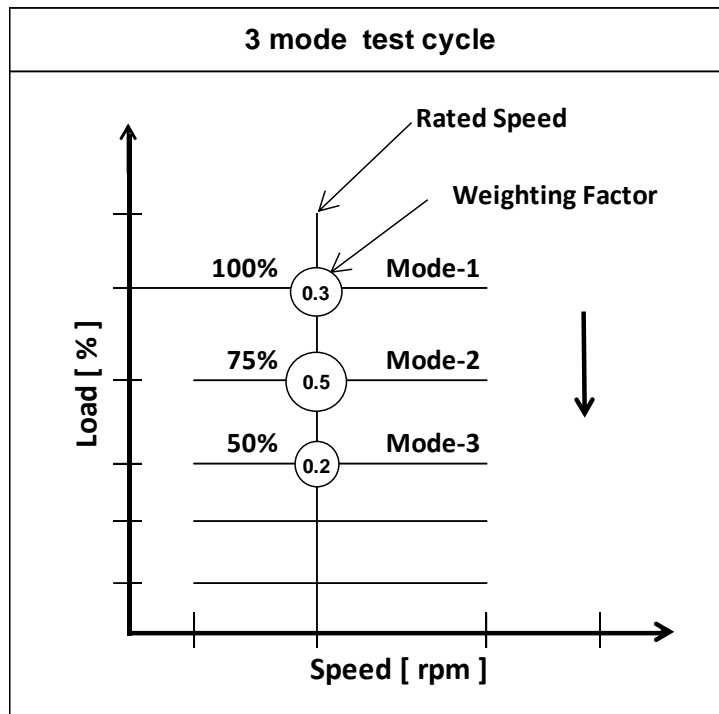

5.0 Specification of the equipment and set up

- The equipment and setup necessary for testing of exhaust emissions of genset as per method prescribed herein, consists of:
- Resistive load bank for electrical loading of the genset, equipped with voltmeter, ammeter, and frequency meter for measurement of the load.
- Exhaust gas analysers for measurement of molar concentrations of CO, CO₂, HC, NO_x and O₂.
- Arrangement for sampling raw or dilution (CVS) exhaust gases, their conditioning for and transfer to analysers.
- Apparatus for measurement of fuel consumption rate.
- Instruments for measurement of:
 - Ambient air pressure and humidity
 - Genset engine inlet air and other temperatures
 - Temperatures of exhaust sample
- Instrumentation and set up for measurement of genset engine inlet air flow rate
- Requirement of type, accuracy, calibration etc. of these equipment

6.0 Resistive Load Bank

- The load bank shall be a single phase (for single phase Gensets only) or 3 phase load circuit, with each phase consisting of:
 - A combination of stable resistive elements of appropriate rating, wired such that the total load current is adjustable to any value up to 125% of max. full throttle current per phase of the genset under test with accuracy of ± 0.1 Amp.
 - The resistive elements shall be capable of withstanding continuous energisation at 150% of the rated voltage of the genset without overheating.
 - The ratings of other circuit elements such as switches, cords etc., shall be consistent with the highest current / voltage to which they may be subjected to in actual operation.
 - A voltmeter, frequency meter and ammeter for measuring the output voltage and frequency of the genset and the total load current respectively.

- i. Voltmeter and ammeter shall be AC RMS meters, direct acting analogue/ digital type conforming to IS 1248 (part 2), accuracy class 0.5. The range and rating shall be appropriate for the genset output to be measured.
 - ii. Frequency meter shall be direct acting analogue (pointer)/ digital type conforming to IS 1248 (part 4), accuracy class 1. The range of frequency meter shall be 45 - 65 Hz.
 - iii. The meters should be calibrated once in a year. The calibration must be traceable to within the specified accuracy with respect to NPL/International standard.
- b) The entire circuit shall be housed in a suitable enclosure for safety and convenience of operation. The configuration shall ensure that under normal conditions:
- i. Accidental touches to live/ hot parts are not possible.
 - ii. There shall be no possibility of short-circuiting. The insulation resistance between each independent conducting path and between conducting path and body of the enclosure shall be $10 \mu\Omega$ min. Further, the insulation system shall withstand 1500 V AC for 1 minute without breakdown and shall be consistent with the maximum temperature to which it may be subjected in operation.
 - iii. The resistive elements and the enclosure do not overheat. If necessary, a cooling fan of adequate capacity shall be provided.

7.0 The Exhaust sampling setup

The Exhaust sampling arrangement shall consist of an extension pipe fitted with an exhaust sample probe connected with the outlet of the normal exhaust system supplied with the product (genset) has shown in fig. 1 & fig.2

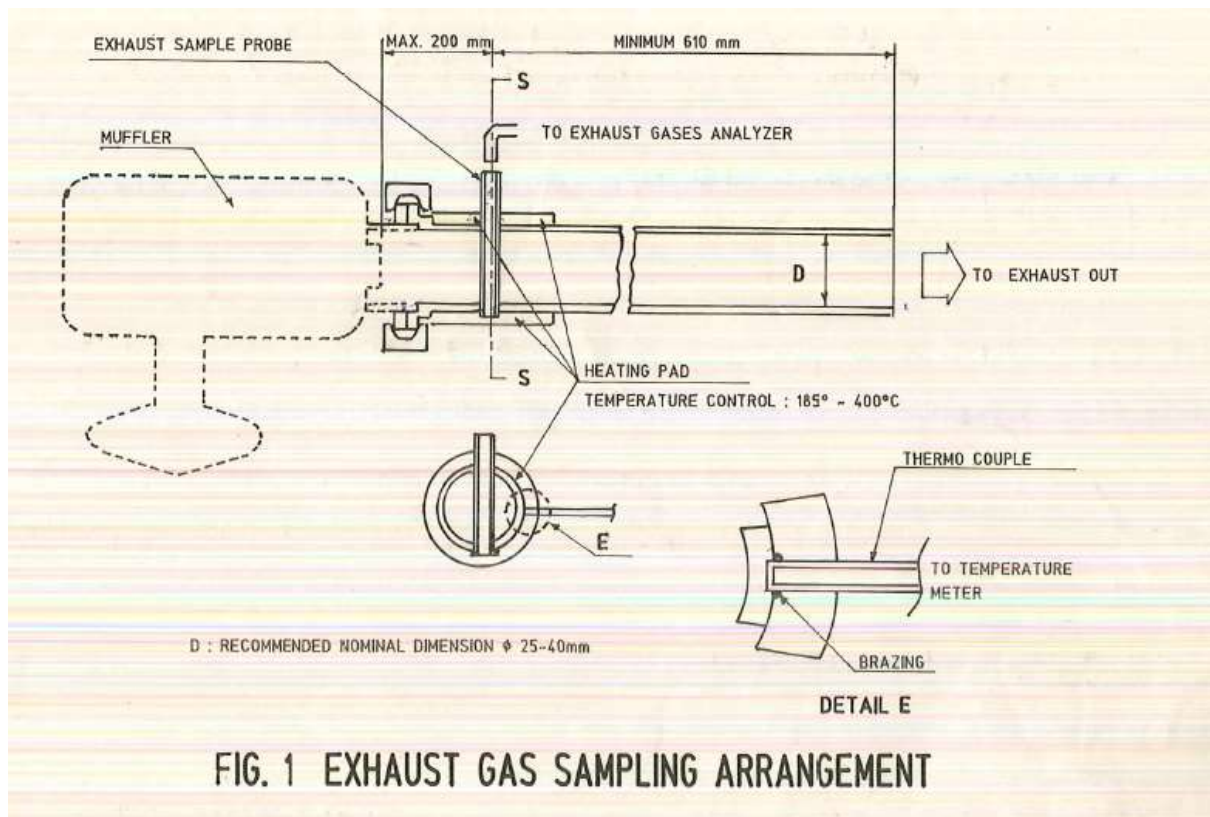

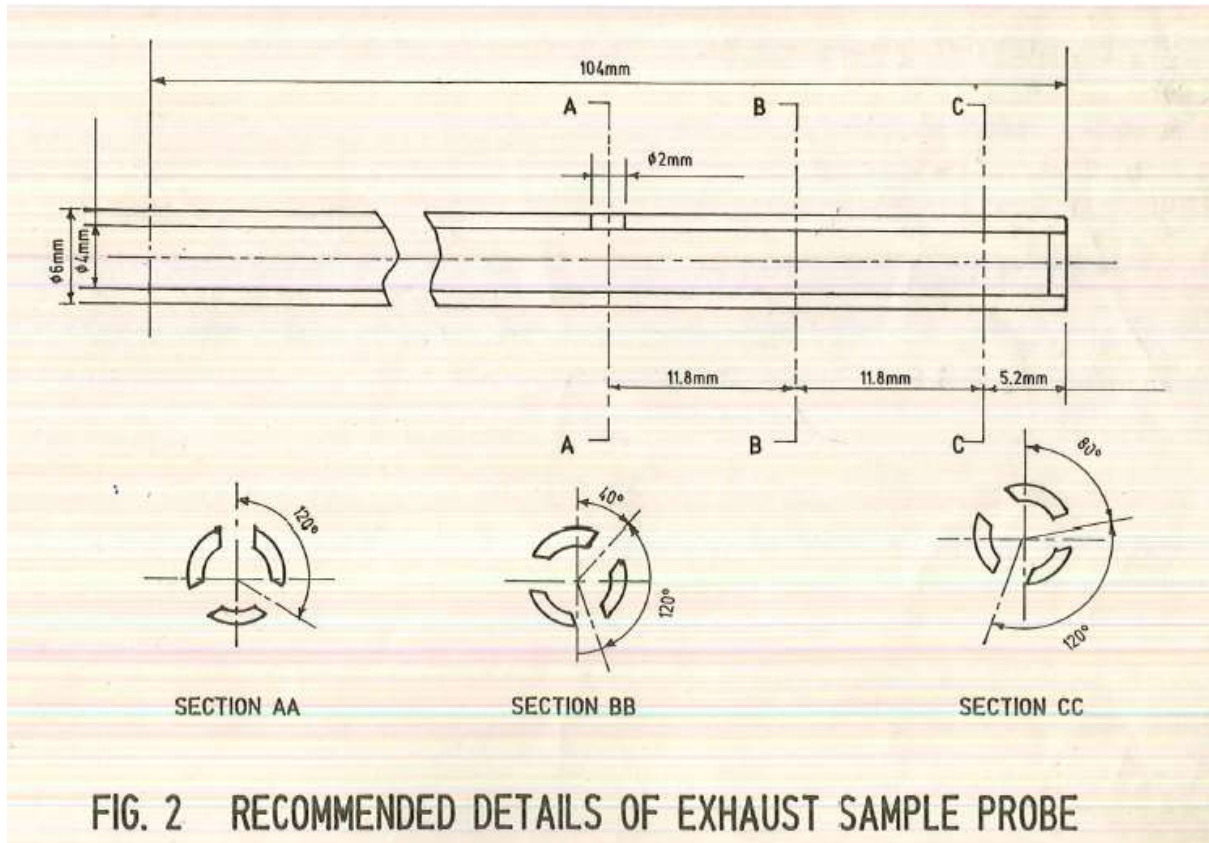

FIG. 2 RECOMMENDED DETAILS OF EXHAUST SAMPLE PROBE

8.0 Test condition

- i. The ambient temperature throughout the test shall be within 10 to 40 deg C.
- ii. The absolute ambient temperature (designated as T & expressed in Kelvin) and dry atmospheric pressure (designated as Ps & expressed in kPa) must meet the following condition for a test to be valid.

$$1. \quad 0.93 \leq Fa = (99/Ps) \times (T / 298)^{0.7} \leq 1.07$$

(Reference for the test condition taken form ISO-8178 and IS-14599)

9.0 Power Correction Factor

The power correction factor is the coefficient by which the measured power must be multiplied to determine the engine power under the reference atmospheric conditions specified as below

$$P_{\text{corr}} = \alpha \times P_{\text{obs}}$$

Where,

P_{corr} is the corrected power (i.e., power under reference atmospheric conditions)

α is the correction factor

P_{obs} is the measured (observed) power (test power)

Reference atmospheric conditions:

Temperature (T): 298K, Dry pressure (Pso): 99kPa

Note: The dry pressure is based on a total pressure of 100 kPa and water Vapour pressure of 1kPa.

Test atmospheric conditions:

The atmospheric conditions during the test shall be the following

Temperature (T): Between 283 K and 313 Pressure (P): Between 80 kPa and 110 kPa

Determination of correction factor:

(The tests may be carried out in air -conditioned tests rooms where the atmospheric conditions may be controlled)

The power correction factor α for Positive Ignition Engines (Naturally aspirated or supercharged) obtained by applying the formula:

The correction Factor (α) is obtained by applying the formula:

$$\alpha = (99 / P_s)^{1.2} \times (T/298)^{0.6}$$

Where,

P_s = the dry atmospheric pressure in kPa, that is the total barometric pressure minus water vapour pressure

T= the absolute temperature in Kelvin (K) at the engine air inlet

The formula applies to carburetted engines and to other engines where the management system is designed to maintain relatively constant fuel / air ratio as ambient conditions change.

(The references for Power correction factor are taken from IS-14599)

10.0 Declared rated corrected Power

The gross declared corrected power of the engine shall be measured at rated speed/frequency of the genset. The measured power and speed may differ from the power and speed declared by the manufacturer as specified below.

a) For Type Approval:

- $\pm 5\%$ at the rated power point

b) For Conformity of Production:

- $\pm 6\%$ of the type approved figure

Declared rated speed/ frequency at rated power point shall vary within $\pm 2\%$

11.0 Test Procedure

➤ **Preparations and Pre-Checks**

- a) Check and confirm that the equipment and test setup confirm to the specifications
- b) Carry out the pre-test calibration and other checks as specified
- c) Install thermocouples or other suitable temperature measuring devices to monitor the temperatures, which constitute criteria of thermal stability as specified by the manufacturer.
- d) Subject the Genset to running in, as per the manufacturer's recommendation, to stabilize its emission characteristics. During and after running-in normal maintenance, as specified by the manufacturer, shall be carried out.
- e) Run the Genset at mode 1 of test cycle as specified and note the corresponding maximum output and fuel consumption. Repeat the check after installation of exhaust sampling set up. If the drop in maximum output or increase in fuel consumption rate, due to installation of exhaust sampling system is greater than 5%, modify the exhaust sampling arrangement keeping in mind the essential requirements specified.

➤ **Emission test**

- a) Run the genset and adjust the load, engine speed and throttle as per mode 1 of test cycle specified in Annexure 4. Run the genset for a sufficient period of time to achieve thermal stability

- (Engine temperature to remain within a band of 10 deg C for 10 minutes). Genset shall be warm up/run as per manufacturer's recommendation to achieve thermal stability,
- b) After achieving thermal stability, initiate the measurement of fuel consumption rate, air flow rate (optional) and emissions:
 - A minimum of 3 readings of fuel consumption rate shall be taken and the duration of each measurement must be minimum 30 seconds. Average of the 3 readings shall be reported.
 - Emission values of each specie shall be monitored / recorded for a continuous period of 2 minutes. Average value of the period shall be reported.
 - Record the appropriate load data
 - c) Repeat a to b for modes 2 & 3 respectively
 - d) The following guidelines must be strictly observed during the testing:
 - Modes shall be performed in the numerical order specified in the test cycle (Annexure 4)
 - In case of doubt in any mode, may be repeated before switching over to the next mode.
 - The load and the engine speed must be maintained as per the test cycle during the period of measurement of emissions, fuel consumption and load. If this requirement is not met, the mode is void and must be completely repeated.
 - If a delay of more than one hour occurs between the end of one mode and the beginning of another mode, the test is void and must be completely repeated.
 - If at any time, during a mode the test equipment malfunctions or the specifications cannot be met, the test is void and must be aborted. Corrective action should be taken and the test restarted.

12.0 Determination of cycle weighted average specific emissions - g/kWh

a) Calculation of emission mass flow rate g/hr

Mass emission rate g/hr shall be calculated as per procedure given in ISO-8178-1 & 4. Caron balance method may be used in case air-flow meter not used considering the availability, simplicity and difficulties for accurate air flow measurement for such small capacity engines. Appropriate dry-wet correction factor & humidity correction factor shall be applied as per formula given in ISO ISO-8178-1 & 4.

b) Calculation of engine power generated during each mode

$$Pi = \frac{V \times A}{1000} \times \eta$$

Where,

Pi – Power in-kW

V -Genset output voltage in volts

A- Load Current in Amps

η - Alternator efficiency, as declared by the supplier

c) Cycle weighted average specific emissions- g/kWh

The specific emissions e_{gas} [g/kWh] are calculated as follows:

$$e_{\text{gas}} = \frac{\sum_{i=1}^{n_{\text{mode}}} (\dot{m}_{\text{gas}i} \times f_{\text{WF}i})}{\sum_{i=1}^{n_{\text{mode}}} (P_i \times f_{\text{WF}i})}$$

where

$\dot{m}_{\text{gas}i}$ is mean emission mass flow rate for the mode i [g/h];

P_i is engine power for the mode i [kW] with P_i

$f_{\text{WF}i}$ is weighting factor for the mode i [-].

13.0 Remark

All other specifications shall also be subject to review as and when necessary based on the experience gained in implementation of emission testing as prescribed in this document.

ANNEXURE – 5

Additional requirement for emission control strategy

Portable genset which rely on the use any external devices, use of regent, or exhaust after treatment devise to reduce emissions, shall ensure the correct operation of emission control measures. In this regard as of now no such emission strategy data is available for the positive ignition portable genset engine category (below 19 kW & upto 800cc engine displacement). However, in future when ample data is available on emission control strategy, the emission control measures requirement will be laid down accordingly.

ANNEXURE – 6

Technical characteristics of fuels prescribed for approval tests and to verify conformity of production tests

The commercially available fuel as prescribed by Govt. of India in CMVR document, Gasoline or NG or Bio-CNG and LPG as applicable shall be used for testing. As specified in this document no other fuel, other than stipulated by CPCB, shall be used to start and run the genset without consent from CPCB. As per the choice of manufacturer, fuel spec reference or commercial may be used.

Following are the fuel specification form CMVR BSVI document

1) Gasoline fuel specification

Specification of Commercial Gasoline Fuel

Characteristics	Unit	Requirements	
		Regular	Premium
Color, visual		Orange	Red
Density @ 15 ⁰ C	Kg/m ³	720-775	720-775
Distillation :			
a) Recovery up to 70 ⁰ C (E 70)	% volume	10-55 (summer) 10-58 (other month)	10-55 (summer) 10-58 (other month)
b) Recovery up to 100 ⁰ C (E 100)	% volume	40-70	40-70
c) Recovery up to 150 ⁰ C (E 150)	% volume	75 min	75 min
d) Final Boiling Point (FBP), max	⁰ C	210	210
e) Residue, max	% volume	2	2
Research Octane Number (RON) min		91	95
Motor Octane Number (MON), min		81	85
Gum content (solvent washed), max	mg/100ml	4	4
Oxidation Stability, min	minutes	360	360
Sulphur, total, max	mg/kg	10	10
Lead content (as Pb), max	g/l	0.005	0.005
Reid Vapour Pressure (RVP) @ 38 ⁰ C, max	kPa	67	67
Vapour Lock Index (VLI)			
a) Summer, max		1050	1050
b) Other months, max		1100	1100
Benzene Content, max	% volume	1	1
Copper strip corrosion for 3 hrs @ 50 ⁰ C, max	rating	Class 1	Class 1
Olefin content, max	% volume	21	18
Aromatics content, max	% volume	35	35
Oxygen content, max	% mass	3.7	4.5
Oxygenates Content			
a) Methanol, max	% volume	3	3
b) Ethanol, max	% volume	10	10
c) Iso-propyl alcohol, max	% volume	10	10
d) Iso-Butyl alcohol, max	% volume	10	10
e) Tertiary-butyl alcohol, max	% volume	7	7
f) Ethers containing 5 or more carbon atoms per molecule, max	% volume	15	15
g) Other oxygenates, max	% volume	8	8
Note:			
<ol style="list-style-type: none"> 1. Test methods and other provisions and details along with the requirements as given above shall be issued by Bureau of Indian Standards. 2. The Aromatics content, (max) shall be permitted up to 40% in North Eastern States till 01.04.2023 			

Technical specification for Reference fuel E-5

Parameter	Unit	Limits ¹		Test method
		Minimum	Maximum	
Research octane number, RON		95.0	-	EN25164/prENISO5164
Motor octane number, MON		85.0	-	EN25163/prENISO5163
Density at 15°C	kg/m ³	743	756	ENISO 3675/ENISO12185
Vapour pressure	kPa	56.0	60.0	ENISO 13016-1(DVPE)
Water content	%v/v		0.015	ASTME 1064
Distillation:				
–Evaporated at70°C	%v/v	24.0	44.0	ENISO3405
–Evaporated at100°C	%v/v	48.0	60.0	ENISO 3405
–Evaporated at150°C	%v/v	82.0	90.0	ENISO 3405
–Final boiling point	°C	190	210	ENISO 3405
Residue	%v/v	—	2.0	ENISO 3405
Hydro-carbon analysis:				
–Olefins	%v/v	3.0	13.0	ASTMD1319
–Aromatics	%v/v	29.0	35.0	ASTMD1319
–Benzene	%v/v	-	1.0	EN12177
–Saturates	%v/v	Report		ASTM1319
Carbon/hydrogen ratio		Report		
Carbon/oxygen ratio		Report		
Induction period ²	minutes	480	-	ENISO 7536
Oxygen content ⁴	%m/m	Report		EN1601
Existent gum	mg/ml	-	0.04	ENISO 6246
Sulphur content ³	mg/kg	-	10	ENISO 20846/ENISO20884
Copper corrosion		-	Class 1	ENISO 2160
Lead content	mg/l	-	5	EN237
Phosphorus content	mg/l	-	1.3	ASTMD3231
Ethanol ⁵	%v/v	4.7	5.3	EN1601/EN 13132

¹ The values quoted in the specifications are "truevalues". For establishing the limit values, the terms of ISO4259:2006 (Petroleum products— Determination and application of precision data in relation to methods of test) have been applied and for fixing a minimum value, a minimum difference of 2 R above zero has been taken into account; for fixing a maximum and minimum value, the minimum difference is 4R (R=reproducibility).

Notwithstanding this measure, which is necessary for technical reasons, the fuel manufacturer shall nevertheless aim at a zero value where the stipulated maximum value is 2R and at the mean value when quoting maximum and minimum limits. Should it be necessary to clarify whether a fuel meets the requirements of the specifications, the terms of ISO4259:2006 shall be applied.

- ²The fuel may contain oxidation inhibitors and metal deactivators normally used to stabilize refinery petrol streams, but detergent/dispersive additives and solvent oils shall not be added.
- ³The actual sulphur content of the fuel used for the type I test shall be reported.
- ⁴Ethanol meeting the specification of prEN15376 is the only oxygenate that shall be intentionally added to the reference fuel.
- ⁵There shall be no intentional addition to this reference fuel of compounds containing phosphorus, iron, manganese or lead.

2) Alternate Fuel specification: Natural Gas/Bio-CNG, LPG

2.1 Liquefied Petroleum Gas

LPG				
<i>Parameter</i>	<i>Unit</i>	<i>Fuel A</i>	<i>Fuel B</i>	<i>Test method</i>
Composition:				EN 27941
C ₃ -content	per cent v/v	30 ± 2	85 ± 2	
C ₄ -content	per cent v/v	Balance ¹	Balance ¹	
< C ₃ , > C ₄	per cent v/v	Maximum 2	Maximum 2	
Olefins	per cent v/v	Maximum 12	Maximum 15	
Evaporation residue	mg/kg	Maximum 50	Maximum 50	EN 15470
Water at 0 °C		Free	Free	EN 15469
Total sulphur content including odorant	mg/kg	Maximum 10	Maximum 10	EN 24260, ASTM D 3246, ASTM 6667
Hydrogen sulphide		None	None	EN ISO 8819
Copper corrosion strip (1h at 40 °C)	Rating	Class 1	Class 1	ISO 6251 ²
Odour		Characteristic	Characteristic	
Motor octane number ³		Minimum 89.0	Minimum 89.0	EN 589 Annex B
Notes:				
¹ Balance shall be read as follows: balance = 100 - C ₃ - <C ₃ - >C ₄ .				
² This method may not accurately determine the presence of corrosive materials if the sample contains corrosion inhibitors or other chemicals which diminish the corrosivity of the sample to the copper strip. Therefore, the addition of such compounds for the sole purpose of biasing the test method is prohibited.				
³ At the request of the engine manufacturer, a higher MON could be used to perform the type approval tests.				

2.2. Type: Natural Gas/ Bio-methane

2.2.1. Specification for reference fuels supplied with fixed properties (eg from a sealed container)

As an alternative to the reference fuels set out in this paragraph, the equivalent fuels in paragraph 2.1.2. of this Annex may be used

Natural Gas/ Bio-methane					
Characteristics	Units	Basis	Limits		Test method
			minimum	maximum	
Reference fuel G_R					
Composition:					
Methane		87	84	89	
Ethane		13	11	15	
Balance ¹	per cent mole	—	—	1	ISO 6974
Sulphur content	mg/m ^{3 2}	—		10	ISO 6326-5
Notes:					
1 Inerts + C ₂₊					
2 Value to be determined at standard conditions 293.2 K (20 °C) and 101.3 kPa.					
Reference fuel G₂₃					
Composition:					
Methane		92.5	91.5	93.5	
Balance ¹	per cent mole	—	—	1	ISO 6974
N ₂	per cent mole	7.5	6.5	8.5	
Sulphur content	mg/m ^{3 2}	—	—	10	ISO 6326-5
Notes:					
1 Inerts (different from N ₂) + C ₂₊ C ₂₊					
2 Value to be determined at 293.2 K (20 °C) and 101.3 kPa.					
Reference fuel G₂₅					
Composition:					
Methane	per cent mole	86	84	88	
Balance ¹	per cent mole	—	—	1	ISO 6974
N ₂	per cent mole	14	12	16	
Sulphur content	mg/m ^{3 2}	—	—	10	ISO 6326-5
Notes:					
1 Inerts (different from N ₂) + C ₂₊ C ₂₊					
2 Value to be determined at 293.2 K (20 °C) and 101.3 kPa.					
Reference fuel G₂₀					

Composition:					
Methane	per cent mole	100	99	100	ISO 6974
Balance ⁽¹⁾	per cent mole	—	—	1	ISO 6974
N ₂	per cent mole				ISO 6974
Sulphur content	mg/m ³ ⁽²⁾	—	—	10	ISO 6326-5
Wobbe Index (net)	MJ/m ³ ⁽³⁾	48.2	47.2	49.2	
<p>⁽¹⁾ Inerts (different from N₂) + C₂ + C₂+</p> <p>⁽²⁾ Value to be determined at 293.2 K (20 °C) and 101.3 kPa.</p> <p>⁽³⁾ Value to be determined at 273.2 K (0 °C) and 101.3 kPa.</p> <p>Note – In absence of availability of reference fuel for testing, commercial available fuel as notified under CMVR shall be used for testing</p>					

2.2.2. Specification for reference fuel supplied from a pipeline with admixture of other gases with gas properties determined by on-site measurement

As an alternative to the reference fuels in this paragraph the equivalent reference fuels in paragraph 2.2.1. of this Annex may be used.

2.2.2.1. The basis of each pipeline reference fuel (GR, G20, ...) shall be gas drawn from a utility gas distribution network, blended, where necessary to meet the corresponding lambda-shift (S_λ) specification in Table A.5-1, with an admixture of one or more of the following commercially (the use of calibration gas for this purpose shall not be required) available gases:

- (a) Carbon dioxide;
- (b) Ethane;
- (c) Methane;
- (d) Nitrogen;
- (e) Propane.

2.2.2.2. The value of S_λ of the resulting blend of pipeline gas and admixture gas shall be within the range specified in Table A.5-1 for the specified reference fuel.

Table A.5-1
Required range of S_λ for each reference fuel

Reference fuel	Minimum S _λ	Maximum S _λ
G _R ²	0.87	0.95
G ₂₀	0.97	1.03
G ₂₃	1.05	1.10
G ₂₅	1.12	1.20

¹ The engine shall not be required to be tested on a gas blend with a Methane Number (MN) less than 70. In the case that the required range of S_λ for G_R would result in an MN less than 70 the value of S_λ for G_R may be adjusted as necessary until a value of MN no less than 70 is attained.

2.2.2.3. The engine test report for each test run shall include the following:

- (a) The admixture gas(es) chosen from the list in paragraph 2.2.2.1. of this Annex;
- (b) The value of S_λ for the resulting fuel blend;
- (c) The Methane Number (MN) of the resulting fuel blend.

ANNEXURE – 7

Compliance to Safety code of practice for alternate fuel generator sets

All Genset run on dedicated Natural Gas (NG) or Liquid Petroleum Gas (LPG), Gasoline and Natural Gas (NG) or Gasoline and Liquid Petroleum Gas (LPG), shall meet Safety requirements prescribed in the SAFETY CODE PRACTICE published by CPCB (Refer PART A4 of this regulation)

ANNEXURE – 8

Additional requirement for variable speed portable generator sets

As of now, no such related data is available for variable speed portable generator sets, hence additional requirement for variable speed portable generator will be formulated in future when ample data is available.

****END****

This page intentionally kept blank

Part – A4

**Safety code of
practice**

1. SCOPE

This **A4** document lays down safety code of practice requirements for compliance to the rules vide notification no. GSR 804(E.) dated 3-Nov-2022 on emission limits for new internal combustion engine up to 800 kW gross power used for power generating set (Genset) application, issued by Ministry of Environment, Forests & Climate change, Government of India.

This document covers general safety, installation and Component testing requirements and methods of test for checking the functionality of NG/LPG Gensets as per various categories as mentioned below,

- a) Dedicated Genset means a Genset powered by a mono-fuel SI engine started and operating with only one fuel at a time. i.e. NG/LPG*
- b) A bi-fuel Genset means a Genset powered by an SI engine started and operating either on any one type of fuel at a time i.e. Petrol or NG/LPG*
- c) Dual fuel engine operation means a two-fuel system having diesel as a primary combustion fuel and NG/LPG as supplementary fuel, both in a certain proportion, throughout the engine operating zone. Such dual fuel Genset engine may operate on diesel stand-alone mode in absence of supplementary gaseous fuel i.e. NG/LPG*

*Alternate fuels - Natural Gas/Bio-methane, LPG (Fuel Specification of these fuels shall be as notified under CMVR as amended from time to time)

Genset to be certified as per safety code of practice as defined in this document at the time of applying for Type Approval of NVH certification. NVH TA certificate shall be issued only after successful completion of safety code of practice certification of the Genset.

2. REFERENCES

The following standards contain provisions, which, through reference in this text, constitute provisions of this document. At the time of publication, the editions indicated were valid. All standards are subject to revision, and parties to agreements based on this standard are encouraged to investigate the possibility of applying the most recent editions of the standards indicated below:

Standard	Title
1364(Part 1): 2002	Hexagon head bolts, screws and nuts of product grades A and B Part 1: Hexagon head bolts (Size range M1.6 to M 64) (fourth revision)
1364(Part 3): 2002	Hexagon head bolts, screws and nuts of product grades A and B Part 3: Hexagon nuts, style 1 (Size range M1.6 to M 64) (fourth revision)
IS 2171:1999	Specification for portable fire extinguishers, dry powder (cartridge type) (fourth revision)
IS 3224:2002	Valve fittings for compressed gas cylinders excluding liquefied petroleum gas (LPG) Cylinders – Specification (third revision)
IS 2379:1990	Pipelines – Identification – Colour Code
IS 6044:2000	Code of practice for liquefied petroleum gas storage installations
GSR 1109 (E) dtd. 13.10.2015	Stationary and Mobile Pressure Vessels (Unfired) Rules (SMPV)
Gas Cylinder Rules, 2016	Released by Petroleum & Explosives Safety Organization (PESO)
IS 2878:2004	Fire Extinguisher, carbon di-oxide type (portable and trolley mounted) specification
IS 7285 (Part 1):2004	Refillable Seamless steel gas cylinders – Specification
Indian Explosives Act- 1884	Indian Explosives Act- 1884
	Stationary and Mobile Pressure Vessels (Unfired) Rules (SMPV)
IS 5844: 2014	Hydrostatic stretch testing of compressed gas cylinders - Recommendations
IS 5903:1970 (2006)	Recommendation Safety Devices of Gas Cylinders
IS 15720: 2008	Road vehicles - Compressed natural gas (CNG) fuel system components - Compartments/sub-compartments
IS 15715:2008	Road vehicles - Compressed natural gas (CNG) fuel system components - Conduits
IS 15716:2006	Road vehicles - Compressed natural gas (CNG) fuel system components - CNG high Pressure fuel line (RIGID) with end connections having pressure exceeding 2.15 MPa
IS 3224:2002	Valve Fittings for Compressed Gas Cylinders

3. DEFINITIONS

1. **“Applicable emission limit”**: Means an emission limit to which an engine is subject to for approval
2. **“Approval of an engine (engine family)”**: Means the approval of an engine type with regards to the level of the emission of gaseous, particulate and smoke pollutants;
3. **“Approval of an engine”**: Means the approval of an engine type or family with regard to the level of emission of gaseous and particulate pollutants by the engine;
4. **“Authorized Person”**: A person, normally a well-acquainted workshop person, authorized by the Genset manufacturer for specially trained for installation, maintenance and periodic inspection of bi-fuel / dedicated /Dual fuel Gensets
5. **“Bi-fuel Genset”**: Means a Genset powered by an SI engine started and operating either on any one type of fuel at a time i.e. Petrol or NG/LPG
6. **“Compressed natural gas (CNG / BIO CNG)”**: Means a compressed gaseous fuel composed predominantly of Methane (CH₄) shall be used as specified by the Government of India from time to time.
7. **“Declared power (kWm)”**: Means rated gross mechanical power declared by manufacturer for type approval at declared rated speed.
8. **“Dedicated Dual fuel engine”**: Dedicated Dual fuel engine operation shall mean a two – fuel system having diesel as a primary combustion fuel and CNG or Bio CNG or LPG as supplementary fuel and such dedicated dual fuel engine shall not operate on diesel stand-alone mode in absence of gaseous fuel or operation of the engine in diesel mode only shall be restricted by reduced power output to 40 percent to cater limp home mode and in such dedicated dual fuel engine, mass emission test will be carried out in dual fuel mode only.”
9. **“Dedicated NG or LPG (Alternate Fueled) Genset engine”**: Shall mean a mono-fuel engine starting and operating with only one fuel, i.e., NG or LPG
10. **“Dual fuel engine”**: Shall mean a two – fuel system having diesel as a primary combustion fuel and CNG or Bio CNG or LPG as supplementary fuel. Such dual fuel engine may operate on diesel stand-alone mode in absence of gaseous fuel.
11. **“Electronic control unit (ECU)”**: Means an engine’s electronic device that uses data from engine sensors to control engine parameters as primary function. ECU may contain more functionality than stated above of interest;

12. **“For Domestic products”**: Date of Manufacture means the date on which the engine is invoiced;
13. **“For Imported products”**: Date of Import means the date of payment of custom duties applicable to the engine or Genset;
14. **“GENSET manufacturer”**: Every manufacturer, importer or assembler (hereinafter referred to as the ‘manufacturer’) of the dedicated NG or LPG engine (hereinafter referred to as ‘engine’) for genset application manufactured or imported into India or dedicated NG or LPG genset (hereinafter referred to as ‘product’), assembled or imported into India.
15. **“Liquefied Natural Gas (LNG)”**: Means a Natural gas that has been cooled to -259 degrees Fahrenheit (-161 degrees Celsius) and at which point it is condensed into a liquid which is colorless, odorless, non-corrosive and non-toxic. Characterized as a cryogenic liquid. Fuel quality for GENSET use shall meet the requirements of BIS specification as notified from time to time by MoPNG, Govt. of India.
16. **“Liquefied Petroleum Gas (LPG)”**: Hereinafter referred as LPG: means a mixture of certain light hydrocarbons derived from petroleum which are gaseous at normal ambient temperature and atmospheric pressure but may be condensed to the liquid state at normal ambient temperature by the application of moderate pressure and meet specification as notified by the Government of India from time to time.
17. **“Manufacturer”**: Means engine or Genset manufacturer, importer or, assembler (as noted in notification);
18. **“Placing on the market”**: Means the action of making available a product covered by this Regulation on the market of a country applying this Regulation, for payment or free of charge, with a view to distribution and/or use in the country
19. **“Power generating set or Genset”**: Means any equipment which is used for electric power generation in absence or failure of grid power utilizing engine system defined in this document as prime mover;
20. **“Type approval”**: Means the approval of an engine type with regard to its emissions measured in accordance with the procedures specified in this regulation.

4. ABBREVIATIONS

BIS	Bureau of Indian Standards
CC	Cubic Centimetre
CI	Compression-ignition (Engine)
COP	Conformity of Production
COP-Year	Period starting 1st July of year till 30th June of subsequent year
CPCB	Central Pollution Control Board
ECM	Electronic control module
EGR	Exhaust gas recirculation
GOEM	Genset Original Equipment Manufacturer
ISO	International Organization for Standardization
LPG	Liquefied Petroleum Gas
PI	Positive Ignition (Engine)

5. SAFETY REQUIREMENTS

5.1 General Design Requirements

5.1.1 The NG/LPG fuel system components shall comply with this standard. The Equipment and systems, approved by the relevant Test Agency notified by MoEF/CPCB, shall be used.

5.1.2 The high-pressure system shall be designed on the basis of the service pressures.

5.1.3 For bi-fuel Gensets, provision shall be made to avoid accelerated deterioration of the non - NG/LPG fuel system as a result of sustained operation on NG/LPG. Such measures shall be as recommended by the original Genset manufacturer (for example, fuel hoses etc.).

5.1.4 All fuel system, Genset and its engine components shall fulfil the following conditions:

They shall withstand the environmental temperatures and other environmental conditions safely during their operational life.

- a) They shall be located with full guard for anticipated damage while the Genset is being used safely. Such damage may be caused by the Genset itself, by extraneous factors such as heat, Genset engine chemical splash (Fuel, oil, cooling liquid, etc.) or by rust.
- b) They shall be located so that they will not suffer corrosion damage by accumulation of water or any type of chemicals.
- c) The blow by of Gaseous fueled engine shall be properly vented out of Canopy of the Genset assembly.
- d) All the fuel lines used for Genset application shall have color coding as per IS 2379
- e) Confirmatory of Production (CoP) testing and its periodicity for NG/CNG/LPG regulators or any other kit components for Genset application shall be as per CMVR applicable for Genset run on NG or LPG, from time to time as per policy of Government of India.

5.1.5 Gas cylinder valve(s) shall be approved by PESO & it shall be located with suitable protection in an accessible and safe place.

5.1.6 Cylinder valves

5.1.6.1 The NG fuel system shall include:

- a) An automatic shut off valve.
- b) A manual or manual override valve located on each gas cylinder or PNG line.

5.1.6.2 LPG valve(s)

LPG valve assembly / cylinder valve and its manifolding system used for Genset application shall conform to requirements of IS:6044-Part 1(amended from time to time). Cylinder Valve shall be approved / endorsed by Petroleum Explosive Safety Organization (PESO) Govt of India.

- 5.1.7 The NG fuel system may include a device (excess flow valve) inside the gas cylinder or a functionally equivalent system to control gas leakage in the event of a rupture in the fuel supply system.
- 5.1.8 The automatic shut off valve shall be in closed position when engine is not running and only be open when:
- a) NG/LPG operation has been selected, either manually or automatically, and
 - b) The engine is cranking or running.

5.2 Cylinder for CNG/LPG or PNG

5.2.1 Design approval.

- 5.2.1.1 CNG Cylinder(s) used in Cascade form for Genset application shall be approved / endorsed by the Petroleum Explosives Safety Organization (PESO), Govt of India as per Gas Cylinder Rules, 2016 (as amended from time to time).
- 5.2.1.2 LPG Cylinders (Industrial/Commercial) used for Genset application shall be approved / endorsed by the PESO. Single LPG cylinder shall not be used for Genset application. Usage of Domestic LPG cylinder(s) for Genset application is strictly prohibited.
- 5.2.1.3 PNG line including its joints and connection for Genset application shall be approved / endorsed by the City Gas Distribution Company (CGD) or Gas Dispensing Agency, as approved by Govt of India from time to time.
- 5.2.2 Periodic retesting of CNG/LPG cylinder (s) shall be carried out as per Gas Cylinder Rules 2016 as amended from time to time.

5.3 Fittings on CNG cylinders & its Cascades and filling connection

- 5.3.1 CNG Cylinder Valve - Each cylinder shall have a manual cylinder shut off valve mounted directly on it capable of shutting off all gas flow from that cylinder. Cylinders and shut-off valve assemblies shall be approved / endorsed by PESO, (including for storage/ refilling permission) as per IS 3224 and Gas Cylinder Rules, 2016 (as amended from time to time).

5.3.2 CNG Filling Connection - The filling connection shall be of the NZS/NGV-1 or any other type as specified by the Government of India from time to time. The filling connection shall be provided on structure of Cascade of CNG cylinder(s).

The basic dimensions for NZS for CNG type are as given in AIS 028 and recommended sizes of NGV – 1 type of filling connections are SAE 9/16” and 7/8”. However, the Genset manufacturer / kit installer may seek the guidance from The Gas Authority of India Ltd. / Ministry of Petroleum and Natural Gas about the use of specific type of NGV – 1 nozzle.

5.3.3 The NZS type filling connection shall be provided with a captive dust plug and NGV-1 type filling connection shall be provided with dust protection cap.

5.3.4 Position of filling connection - The filling connection shall be located in suitably protected and ventilated location of Cascade or CNG/LPG Cylinder mounting structure, and shall comply with the following:

- a) The filling connection is made and filling is supervised from outside the Cylinder mounting Structure.
- b) The filling connection is protected by being located by providing suitable mean.
- c) The filling connection shall be mounted in such a manner as to resist, without permanent deformation of the mounting attachment, a proof load of 50 kgf applied in any direction. The proof load shall be applied by full engagement of the filling connection and shall be representative of attempted movement of the Cylinder/ its Structure while refueling.
- d) The filling operation can be carried out without requiring the operator to lie or crawl or be otherwise subjected to inconvenience, discomfort or hazard.

5.3.5 Non-igniting material: Filling connections material shall be of non-igniting material.

5.3.6 Non-Return Valve: There shall be a non-return valve fitted on the refuelling line to prevent the return flow of gas from the cylinder to the filling connection. The non-return valve shall be located as close to the filling connection as it is practicable.

5.3.7 Excess Flow Valve: A device may be fitted in the fuel line preferably at the inlet or outlet of the NG/LPG cylinder valve which prevents the total contents of the cylinder from discharging to atmosphere in the event of rupture to any part of the fuel line or components.

5.4 Location, Ventilation and Mounting of NG/LPG Cylinders

5.4.1 Cylinders, Fittings and Pipe work

5.4.1.1 Cylinders shall be located so that the safety characteristics shall not be adversely affected

5.4.1.2 Shielding to NG/LPG cylinders or NG/LPG joints & connection:

In case of NG/LPG cylinder or NG / LPG line shall be routed such that, it shall not get damage from loose metal or other objects being thrown up from the outside, effective shielding against these shall be provided.

5.4.1.3 The cylinder shall be situated and vented so that any gas escaping due to leakage from the cylinder valve shall not enter the Canopy space of Genset. Leak sensors shall be provided to avoid any fire hazard in case of leakage.

5.4.1.4 The clearance between the cylinder(s) and the exhaust shall not be less than 75 mm. or Heat shielding is must.

5.4.1.5 Cylinders and/or NG /LPG pipeline shall not be fitted in any inaccessible position.

5.4.2 Effective protection to Cylinder/NG/LPG line:

- a) The whole body of the cylinder(s) together with its attached components Shall not be fitted inside the Canopy of Genset
- b) The valves and pipe connections associated with or attached to the cylinder shall be well ventilated to the atmosphere. Provision shall be made for ready access to the cylinder valve in all installation arrangements.

5.5 Cylinder(s) installation

5.5.1 LPG Cylinders Mounting Safety:

LPG Cylinders, valve assembly and manifolding system used for Genset application shall conform to requirements of IS:6044 (amended from time to time) and following requirements shall be met:

- a) Those responsible for the installation of cylinders, equipment and piping should understand the characteristics of LPG and be trained in good practice of handling, installing and maintaining installations.
- b) Cylinders and cylinder valves shall comply with the standard approved by the Chief Controller of Explosives (CCoE). All other equipment such as pressure regulators and other installation material shall comply with distributing company's stipulations and meet IS specifications, wherever available. Wherever any thread joint is provided, a suitable jointing compound be used on male thread.
- c) Gas piping shall be of the color stipulated by the explosive authorities to distinguish it from other piping and the piping shall be painted silver grey with red band of 150 mm width.
- d) Fire extinguishers of dry powder type (see IS 2171) or carbon dioxide (see IS 2878) type shall be provided in places where LPG cylinder installations are situated and shall be located near

such installations. Two buckets filled with sand and two with water shall also be installed nearby. The number, type and size of the fire extinguishers for LPG shall be as per IS 6044 (Part 1) amended from time to time

- e) If total weight of gas exceeds 100 kg, then license is required to be obtained from PESO as per Gas Cylinder Rule 2016 (amended from time to time)
- f) Before any system of gas piping is finally put into service, it shall be carefully tested to ensure that it is gas-tight.
- g) Naked flames shall never be used for checking gas-tightness of the installation.

5.5.2 CNG Cylinders & its Cascade Safety:

5.5.2.1 Cylinders conforming to IS :7285 duly approved by PESO shall be used in CNG Cascade form. The Cascade shall be equipped with safety devices such as shut off valve, excess flow valve (if required), Check valve (if required), Pressure gauge etc.

5.5.2.2 The design, construction, manufacture, testing and other general requirements of the Storage Cascades should be strictly in accordance with the Applicable Standards and Codes and should comply fully with relevant Indian / International standards, Gas Cylinder Rules 2016, Indian Explosives Act- 1884, Stationary and Mobile Pressure Vessels (Unfired) Rules (SMPV), CNG Cylinder Design Code IS:7285 , CNG Cylinder Valves as per IS:3224, Hydrostatic Stretch Test as per IS: 5844, Safety Devices of Gas Cylinders as per IS : 5903, etc. and their amendments time to time.

5.5.2.3 CNG cascade and its storage area shall be equipped with the following safety equipment / firefighting equipment:

- a) The burst disc shall rupture on excess pressure as well as excess temperature either individually or in combination. Discharge from the burst discs shall be manifolded to a common header for safe venting.
- b) The sizing of connecting tubing between each outlet and its associated cylinder shall be such that where they join the total incoming flow areas shall not be less than the total outgoing area. The loops in the tube work shall be provided for absorbing contraction, expansion and vibration. Piping/ tubing shall be suitably clamped to the frame structure.
- c) Cylinders installed horizontally should be separated from one another in each storage unit by a distance of not less than 30 mm. The material used to separate the cylinders should be sufficiently strong enough and should not absorb moisture. Special precautions should be taken to avoid corrosion at the point of contact.
- d) CNG cascade structure shall be made of corrosion resistant material and to be protected by painting or other equivalent means necessary to prevent corrosion. All structural items

used in the frame shall be weather proof. Frame shall be suitably covered with canopy from top to avoid the ingress of rain water.

- e) All manifold piping to be tested after assembly to a pressure equal to that of the pressure relief device setting and shall be leak free.
- f) Every CNG storage unit including each manifold group or bulk storage tank should be provided with a suitable pressure gauge for each bank. The pressure gauge should be directly connected to the tank or storage system. The dial gauge should be graduated to read approximately double the operating pressure. Pressure gauge should be equipped with 3-way relief/ isolation valve.
- g) All cylinder tubing, manual isolation valves and pressure relief valves should be protected from hitting by any moving object and should not protrude outside the metal frame or brackets.
- h) Flame proof light shall be used inside Cascade area.
- i) Leak Detection Sensor(s) shall be used.
- j) Fire Extinguishers and sand buckets shall be used as per Gas Cylinder Rules 2016.
- k) Remote Operated valve / Solenoid valve shall be used.
- l) Quick release Coupling (if required) and Vent to release pressure before disconnection of quick release coupling hose shall be used.
- m) Water Sprinkling arrangement shall be used, if required, above cascade storage area.
- n) Safety Sign board, such as - No smoking, No mobile, Entry Restricted for Authorized Person Only, etc. - shall be displayed on all four sides of the storage area.
- o) If total number of CNG cylinders exceed 25 Nos and/or the total weight of CNG exceeds 200 kg., then license is required to be obtained from PESO as per Gas Cylinder Rules 2016 (amended time to time).

5.5.2.4 CNG Cylinders shall be securely attached to structure of Cascade to prevent slipping; rotating and jarring loose, in accordance with the following requirements:

- a) The method of attachment shall not cause undue stresses or wear in the cylinder shell;
- b) The mounting method shall not significantly weaken the mounting structure, and reinforcement shall be added where necessary to ensure compliance with (c) below. An air gap of not less than 5 mm shall be provided between the cylinders and its mounting structure and in between cylinders.
- c) The force necessary to separate the cylinder from the e shall not be less than 20 times the mass of the full cylinder in any direction.
- d) The strength of the anchorages may be established by static test (forces directed through the center of mass of the cylinder).

- e) In the absence of testing or where calculations are impracticable, the following design requirements shall apply:
- i. There shall be at least 4 points of attachment to the mounting structure. The spacing between these shall be sufficient to ensure the stability of the cylinder. These bands shall not mask the identification markings of the cylinder.
 - ii. Where a cylinder is anchored to steel sheet metal the sheet metal shall be reinforced by a plate of not less than 3600 mm² and a thickness of not less than 2.5 mm or appropriate thickness supported by the calculation or test report. It is preferred that a round washer be used but where a square plate is fitted the corners shall be rounded. Any such reinforcement plate/washer shall be contoured to the shape of the sheet metal or mounting structure.
 - iii. Where anchorage bolts pass through a hollow section, provision shall be made to prevent collapse of that section under load.
 - iv. Anchorage bolts or studs shall have a diameter not less than that shown in Table 1 and shall conform to strength grade 8.8 of IS 1364 (Part 1) and nuts also to IS: 1364 (Part 3).
 - v. Where clamping bands are used, at least two steel bands per cylinder shall be provided, the dimensions, of which shall not be less than those in Table 1.
 - vi. Screwed fasteners or clamping devices shall either be inherently resistant to loosening or be locked or pinned after tightening.

Table 1: Band and Bolt or Stud Dimensions

Cylinder size (water capacity in l) Over, up to and including (l)	Band dimensions – Minimum nominal size (mm)	Bolt or stud diameter for strap or flange mountings minimum nominal size (mm)
0 -30	30 x 2	10
30-100	30x3	10
100 150	50 x 6	12
Above 150	Specific design required	--

NOTE: To prevent possibility of external corrosion where clamping bands are used, check that the material of the padding / lining provided for inner side of cylinder mounting band (s) is made up of EPDM rubber (hardness Shore A 60 min.) as approved by the test agency during type approval certification. Similar adequate protection to the cylinder shall also be provided wherever the cylinder rests against other metal objects such as the mounting frame.

5.5.3 Cylinder Manifolding

CNG Cascade cylinders to be manifolded together in such a way that all cylinders can be simultaneously filled from any filling point. Each cylinder shall retain its required individual NG/LPG cylinder valve/MFV respectively.

In case of LPG cylinders and its Manifolding, Non-Return Valves (NRVs) shall be used to avoid flow of gas from one cylinder to another and installation shall meet requirements of IS:6044 (part 1) as amended from time to time

5.5.4 Cylinder identification markings should be capable of being read when in the installed position.

5.6 Shielding

Cylinders/ NG/LPG joints shall be installed to ensure that valves and connections on cylinders/NG/LPG line shall be protected to minimize the possibility of damage due to accidental contact with stationary objects or from loose objects thrown up from outside.

5.7 Construction of compartments and sub-compartments

5.7.1 A cylinder compartment or sub-compartment shall be provided if cylinder is mounted in the enclosed space & comply with the following requirements & shall meet component test requirements as per IS 15720.

- a) Construction shall be such that any gas which might leak from any fittings, component or piping, cannot pass to any other enclosed compartment canopy space.
- b) It shall be possible to operate the cylinder service shut-off valve in the installed position. The valve may be arranged so that it can be operated from some internal area of the Genset Canopy. Gas installation provided that the sealing of the compartment or sub-compartment shell is maintained by one of the following means, as appropriate:
 - i. If a valve actuating device passes through the shell a gas-tight seal shall be provided.
 - ii. If the actuating handle is wholly within the shell, access shall be a gas-tight captive hatch. The design shall not need tools to open the hatch.
- c) A compartment or sub-compartment shall not contain ignition sources or electrical equipment or wiring unless it is intrinsically safe.

5.7.2 Ventilation

One or more vents to the outside of the enclosed space shall be provided, the aggregate area of which shall not be less than 550 mm². The vent line shall be so located as to exhaust any gas, which may accumulate in the compartment or sub-compartment to atmosphere and shall not exit less than 75 mm from an exhaust pipe or other heat source of Genset.

5.7.3 Ducting

5.7.3.1 All piping or hoses that pass through an enclosed space shall be within a conduit gas-tight, vented unobstructed to outside atmosphere and protected from external damage and shall meet component test requirements as per IS 15715 (for NG/CNG) /AIS 26(LPG) and comply with the following requirements:

- a) The ducting shall be as short as practicable.
- b) The connections shall be mechanically clamped and shall not depend on adhesives or sealing compounds to retain them in place. Protection in the form of a gasket shall be provided to prevent damage to the ducting material by the clamping device.

- c) The material of the conduit used for ducting shall be sufficiently strong to resist mechanical damage, preserve venting integrity, protect the piping or hose within it, shall not support combustion

5.7.3.2 Where the sub-compartment is removed to initiate repairs or at the periodic inspection special attention shall be given to the inspection of the material to ensure that no degradation of material has taken place. Any sub-compartment showing signs of degradation shall be replaced.

5.7.3.3 The cylinder valve actuating device position shall be clearly identified and shall have provided adequate material to allow closing of the valve without damage to the sub-compartment sealing.

5.7.3.4 The pliable sub-compartment (for NG) shall be shielded or installed in a protected location to prevent damage, from unsecured objects and abrasion. The material shall be sufficiently strong to resist mechanical damage, preserve venting integrity, shall not support combustion.

5.8 NG/CNG/LPG Fuel Line

5.8.1 NG/CNG fuel line - pressure exceeding 100 kPa (high pressure fuel line)

5.8.1.1 Rigid piping and connections for use with pressures exceeding 2.15 MPa shall be made up of cold Drawn Steel/ SS and conform to IS 15716. In case of PNG, the pipeline shall be approved by CGD company.

5.8.1.2 CNG/PNG fuel line and connections for use with pressures exceeding 100 kPa but less than 2.15 MPa shall be tested as per IS 15722 or the pipeline shall be approved by CGD company.

5.8.2 Flexible hose exceeding 2.15 MPa

5.8.2.1 NG Flexible hose shall meet the requirements of AIS 028. Each flexible hose assembly shall be permanently and clearly marked with the manufacturer's name and trademark, type, size and design working pressure. It shall be identifiable as being suitable for CNG/PNG use either by marking it with 'CNG/PNG' or with a specification mark.

5.8.3 LPG pipe line shall meet requirements as specified in IS:6044(part 1) as amended from time to time.

a) **Inspection:** At the time of periodic inspection the hose shall be inspected for twists, kinks and damage or abrasions to the cover which expose the wire. The hose shall be condemned on detection of any one of these defects. At no time shall flexible hose be placed back into service after removal from the Genset Engine.

b) Joints and connections:

- i. The number of joints and connections shall be the minimum for the inclusion of all components.
- ii. Joints or connections in LPG fuel lines shall be in accessible positions for easy inspection.

c) Flexibility

- i. Low pressure hose shall be of sufficient length and flexible to accommodate engine movement.
- ii. High pressure fuel line shall be installed so as to accommodate any relative movement between chassis/body and fuel system components or temperature variations in the fuel line.

5.8.4 All runs or rigid fuel line piping between any two components shall be installed with a 'pigtail' or U bend to provide this essential flexibility.

5.8.5 Inspection

5.8.5.1 The hose shall be inspected for twists, kinks and damage or abrasions to the cover, which expose the wire. The hose shall be condemned on detection of any one of these defects.

5.8.5.2 At no time shall flexible hose be placed back into service after removal for service.

5.8.5.3 Joints and connections for CNG.

5.8.5.4 Every joint or connective fitting in rigid high-pressure fuel line shall be as per IS 15716.

5.8.5.5 The number of joints and connections shall be the minimum for the inclusion of all components.

5.8.5.6 Joints or connections in a CNG/PNG fuel line shall be in accessible positions for easy inspection.

5.8.5.7 Connection means shall provide positive retention of the fuel line in the fitting (e.g. by double inverted flaring of the tube end or by ferrule type compression fitting).

5.8.6 Securing and location.

CNG/PNG /LPG pressure piping and hoses shall comply with the following:

- a) CNG/PNG/LPG fuel line inside the part of any Canopy shall have leak free joints.
- b) All CNG/PNG/LPG fuel lines shall be positioned for protection from the possibility of damage by impact, accident or loose objects.

- c) CNG/PNG/LPG fuel lines shall not be located inside box sections or in other in accessible locations nor shall they be installed in any location, which is not adequately protected from sources of heat, abrasion, or from impact.
- d) Fuel lines shall follow the shortest practical route considering the requirements
- e) Rigid fuel lines shall be effectively secured by clips spaced not more than 600 mm apart. In order to prevent the possibility of fretting corrosion or erosion of the fuel line cushioning must be provided to protect the fuel line from both the mounting structure and the clips themselves. Suitable grommets must be provided where the fuel line passes through any panel of Canopy.
- f) PNG/LPG pipe line & Manifolds used in multi-cylinder shall be installed in a protected location. Manifold branch pipelines shall be sufficiently flexible to prevent damage to the lines, valves and fittings due to vibration, expansion or contraction.
- g) In no case shall the clearance between the exhaust system and the fuel line be less than 75 mm.
- h) Fuel lines shall not be installed where any part will be permanently hidden from sight or cannot be inspected or easily replaced.

5.8.7 All CNG/PNG fuel lines for use for service pressure not exceeding 100 kPa (low pressure hose) shall be of flexible material and shall meet requirements of IS 15722. Joints and connections for low pressure fuel lines shall be suitable for use with CNG/PNG and shall meet requirements of IS 15722.

5.8.8 Flexibility

5.8.8.1 Low pressure hose shall be of sufficient length to accommodate engine movement.

5.8.8.2 High pressure fuel line shall be installed so as to accommodate any relative movement between engine and fuel system components or temperature variations in the fuel line.

5.8.8.3 All runs of rigid fuel line piping between any two components shall be installed with a 'pigtail' or U bend to provide this essential flexibility. The dimension for U bend shall be not less than 50 mm radius at the bend portion of U or 100 mm diameter for the pig tail coil and number of coils shall not be more than two.

5.9 CNG/PNG/LPG Control Equipment

5.9.1 Definition

The CNG/PNG/LPG fuel control equipment includes all the equipment necessary to convert PNG/CNG/LPG at high pressure at the cylinder/PNG line to CNG/PNG air mixer/fuel injector for supply to the engine & shall meet requirements of corresponding component standards as applicable.

The Genset engine control equipment includes all the equipment used to convert a compression ignition engine to run on a dedicated gaseous fuel or Dual fuel (diesel + Gas). This includes devices such as fuel provision and control device, the ignition system (if one is used), the speed and/or load governing device (if any), and any engine protection devices such as temperature and pressure alarms, and knock detection systems.

5.9.2 Control Equipment

5.9.2.1 Filter

At the termination of every CNG/PNG/LPG service fuel line immediately prior to any regulator component there shall be a properly designed filter capable of removing all particulate matter from the fuel that could cause malfunction of such regulator components.

5.9.2.2 CNG/PNG/LPG shut-off valve

This valve shall shut-off fuel supply to the engine when activated by the fuel change over control on bi-fuel operation and by the ignition switch on single fuel operation. Normally this is a regulator component but, in any case, it shall be located downstream of the filter. This valve shall automatically shut-off the fuel supply to the engine unless the following conditions are satisfied:

- a) The ignition is on;
- b) The engine is turning;

5.9.2.3 Service shut-off valve

A service shut-off valve shall be installed in the high-pressure line between the cylinder valve and any other valve or component within the engine compartment and as close as practicable to the Regulator/vaporizer (for LPG), however it is acceptable to install the valve at the refuelling point. It shall be possible to readily operate the valve in the installed position at all times in particular during the refuelling operation. A permanent label shall be provided 'CNG/PNG/LPG service shut- off valve' or similar wording to positively indicate its purpose and a positive indication of "Closed" and "Open" positions of the valve shall be clearly marked.

5.9.2.4 Regulator (NG/CNG)/Vaporizer (LPG) system for Genset Engine

The regulator/vaporizer system shall not permit gas to pass after the engine has stopped turning, irrespective of whether the ignition is on or off. The regulator shall be installed so that:

- a) It is securely mounted as far as practical from the extremities of the Genset engine.
- b) It is mounted securely and as close to the engine Gas Air Mixer or Injector position as convenient.

- c) It is easily accessible for routine maintenance, adjustment and inspection.
- d) It is situated as far from the exhaust system as practical. Where this distance is less than 150 mm it shall be shielded from radiant heat and any impingement from exhaust gases due to exhaust system failure.
- e) It is reasonably protected from impact in a collision.
- f) It allows sufficient free movement of all hoses.
- g) The water circulating system (where required) is connected in accordance with the manufacturer's instructions, and no flow control valve in the system can shut-off original equipment water flow.
- h) Where possible, the regulator should be at lower level than top of the radiator, as insufficient water may cause freezing.

5.9.2.5 The regulator/vaporizer assembly shall not be attached to the engine assembly unless otherwise specified by the manufacturer and then shall be fitted only in accordance with the manufacturer's recommended instructions.

5.9.2.6 Gas air mixer /Injector

5.9.2.6.1 A backfire deflector to arrest back-fire shall be installed in the air intake immediately prior to the mixer/injector. The back-fire deflector shall meet the requirements of Annexure 2 of this standard.

5.9.2.6.2 In case of Genset engines more than 19kW & up to 800 kW, there shall be installed in the air intake prior to the mixer a backfire deflector (original air filter acceptable). In turbo charged applications where rigid piping is fitted from the turbo charger to the intake manifold a pressure relief valve shall be fitted as close as practicable to the intake manifold. Where a volume of gas/air mixer, due to turbo charging or inter/after coolers is contained downstream of the mixer, special precautions will need to be applied to avoid damage to components downstream of the mixer/injector due to backfire.

5.9.2.6.3 Genset manufacturer / kit manufacturer / kit supplier shall submit test report or certificate complying with the above requirement. It is not necessary to carry out the test if declaration is not submitted.

5.9.2.6.4 The mixer/injector shall be securely mounted and when remotely fitted shall be suitably bracketed to support its own weight and applied working forces.

5.9.2.6.5 There shall be no filter element fitted downstream of the gas air mixer/injector.

5.9.2.7 Bi- fuel /Dedicated/Dual fuel system.

Bi- fuel type.

- a) A bi-fuel system is defined as a system equipped to operate with either on CNG/PNG/LPG or some other fuel e.g. petrol.
- b) Dedicated fuel type. A dedicated system is defined as a system equipped to operate wholly on CNG/PNG/LPG.
- c) Dual fuel engine operation means a two-fuel system having diesel as a primary combustion fuel and CNG/PNG/LPG as supplementary fuel, both in a certain proportion, throughout the engine operating zone. Such dual fuel Genset engine may operate on diesel stand-alone mode in absence of supplementary gaseous fuel i.e. NG/CNG/LPG

For bi-fuel type

5.9.2.8 A shut-off device shall be installed in the bi-fuel fuel system. This device shall shut-off the optional fuel supply to the engine when this fuel is not required.

5.9.2.9 If the shut-off device is in the form of a solenoid operated shut-off valve it must be fitted between the fuel pump and the carburettor. The valve shall be mounted securely so that its weight is not transferred to any part of the carburettor or fuel lines.

5.9.2.10 Where the shut-off device is mounted remotely from the engine, flexible hose shall be used of sufficient length to accommodate engine movement. In all cases the device shall be mounted in a position reasonably protected from damage in a collision and shall be as far as practicable from high tension electrical equipment.

5.9.2.11 Bypass relief device

A bypass relief device shall be installed in the fuel pump or between the fuel pump and the automatic shut-off valve in the liquid fuel line to the carburettor on Genset engine equipped with bi- fuel systems for the use of petrol and gaseous fuel. The relief device need not be installed on fuel pumps containing a bypass relief device as original equipment.

5.9.2.12 Fuel selection control

A fuel selection control shall be provided which shall have at least three positions in case of bi fuel and two positions in case of Dual fuel, clearly marked for the selection of each of the two fuels or two mode of operation. The selection control shall be placed within easy reach of operator.

5.9.3 Installation

The CNG/PNG/LPG control equipment shall be:

- a) Installed in positions that are accessible for routine inspection, maintenance adjustment.
- b) Mounted securely and reasonably protected from damage in a collision.
- c) Remote from the Genset engine exhaust system or protected therefrom by a metal shield.
- d) No closer than is avoidable and practicable to any electrical equipment capable of sparking.

5.9.4 Electrical wiring used for CNG/LPG system.

- 5.9.4.1 All wiring shall be properly installed, taped, clipped or contained in a loom along its length.
- 5.9.4.2 Wiring cables shall comply with the requirements of IS 15719 or clause No 4.3 of AIS 028 or clause No 12 of 026. The kit supplier / kit manufacturer or Genset manufacturer shall submit test certificate / test report complying with requirements of IS 15719.
- 5.9.4.3 The electrical circuit shall be provided with a current limiting device conforming to IS 15723 or clause No 4.3 of AIS 028 or clause No 12 of 026. This equipment or fuse shall be dedicated to the CNG/PNG/LPG fuel system.

5.9.5 Connectors and terminals.

Connectors and terminals shall be insulated to prevent accidental earthing during operations or routine servicing.

5.9.6 Pressure indicator (NG)/ Level indicator (LPG)

- 5.9.6.1 A pressure/level indicator to indicate pressure in the CNG/PNG/LPG (in case of LPG ref IS:6044 requirements) system shall be fitted in an easily visible position to service personnel at the regulator or fill point preferably within the engine compartment.
- 5.9.6.2 A supplementary gauge or electronic gauge may be placed in the Genset Control panel provided any gauge shall be gas isolated from the cylinder or piping to prevent gas leaking into the compartment.

5.10 COMPLIANCE PLATE

In addition to Label as prescribed, a compliance shall be provided on LPG/CNG cylinder(s) structure/Cascade, displaying the following information, shall be installed near the filling connection and be clearly visible to the re-fueller:

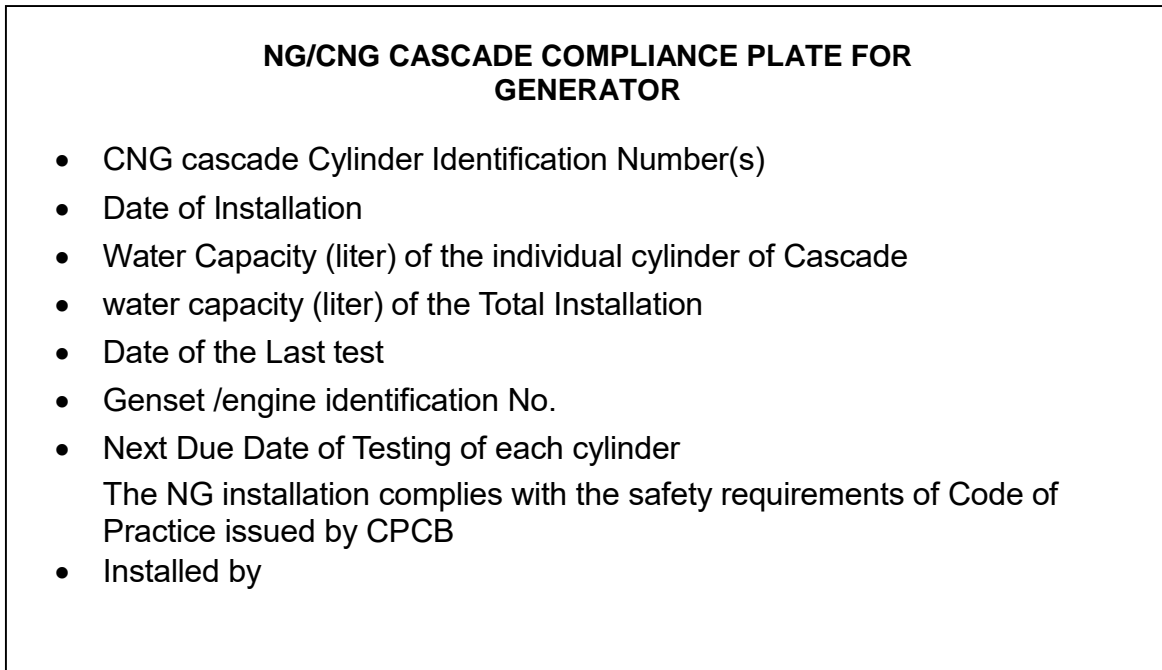

5.11 LABELS

5.11.1 Identification labels

Genset using a CNG/PNG/LPG system shall be labelled as follows:

Labels conforming with the following specification shall be affixed in a vertical position on Canopy & shall ensure visibility from the front sides.

Gensets, individually or as part of the product shall be clearly labelled on Canopy 'Dedicated NG/LPG Genset' 'bi-fuel NG/LPG Genset' or 'Duel fuel LPG/NG Genset' as the case may be.

5.11.2 The label shall always be in position, shall be in good condition, and the shape, colour and lettering shall be easily visible.

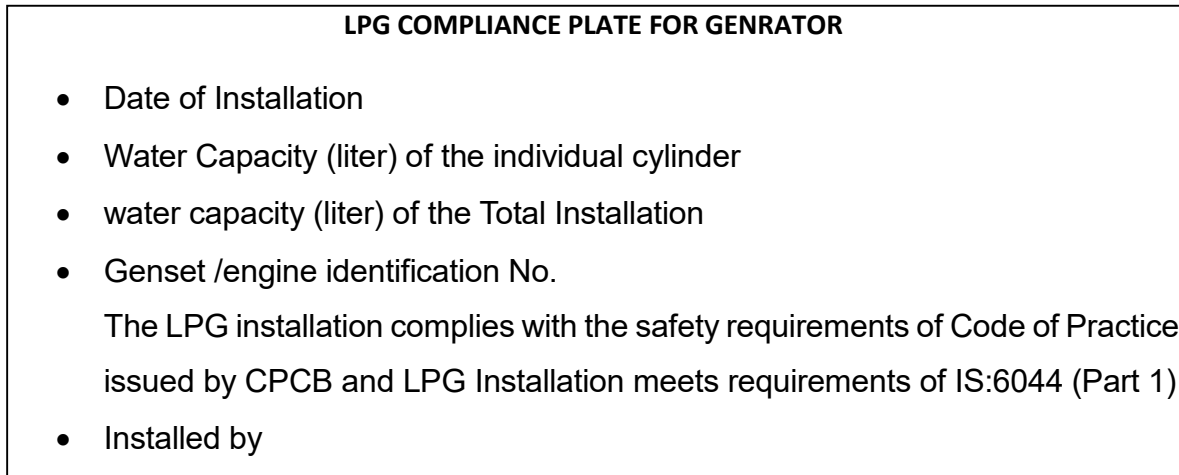

- a) All the engines, individually or as part of the product shall be clearly engraved on the cylinder block for respective Genset, as the case may be.
- b) The engine or the product shall be affixed with a conformance label meeting the following requirements namely: -
- i. The label shall be durable and legible.
 - ii. The labels shall be affixed on a part necessary for normal operation of the engine or the product and not normally requiring replacement during the life of the engine or the product.
- c) The conformance label shall contain the following information, namely: -
- i. Name and address of the manufacturer of engine or product, as the case may be;
 - ii. Statement that the engine or product conforms to the stipulation in the Environment (Protection) Rules, 1986;
 - iii. Type Approval certificate number for emission standards and Noise Limits;
 - iv. Date of manufacture of engine and the product or, the date of import of the engine and the product, as the case may be; and
 - v. Rated speed and corresponding gross power in kW for engine and 'Noise Limit viz. 75 dB(A) at 1m' for product.

6. INSTRUCTIONS TO BE PROVIDED BY THE GENSET MANUFACTURER

- a) Clear, concise printed instructions and diagrams, stated in terms clearly understandable and adequate for proper assembly, installation, maintenance and safe operation, shall be made available by the Genset manufacturer for CNG/PNG/LPG kit component and component package.
- b) Instructions for periodic maintenance of components, as required, shall be provided. Parts, which require replacement, shall be identified.
- c) Printed instructions shall state that the installation shall be in accordance with the prevailing regulations of Govt. of India or, in the absence of which, in accordance with this standard.
- d) This information shall be easily understood.
- e) An instruction manual shall be provided including specific instructions regarding NG/LPG operation and alerting the owner to the cylinder inspection and expiry date.

7. INSPECTION, TESTING AND COMMISSIONING BY GENSET MANUFACTURER OR AUTHORIZED PERSON APPOINTED BY GENSET MANUFACTURER

7.1 Commissioning

Prior to initial use, an inspection of the CNG/PNG/LPG system and components shall be carried out by, or under the supervision of trained person, who shall also carry out a complete examination to ensure the system complies of all relevant sections of this standard and any other statutory requirements as specified by the Central Government.

7.2 Initial inspection and installation certificate

The system shall be leak tested. The installation shall be inspected for compliance with this Standard and all components shall be checked for operational performance. In the case of bi-fuel/dual fuel installations, the ability for the Genset engine to operate on the optional fuel shall also be tested.

When the system conforms to this standard, an installation certificate, as per Annex D of this standard, signed by Genset Manufacturer/its authorized person shall be issued to the owner.

7.3 Periodic Inspection /preventive maintenance

The cylinder or NG/LPG manifold, piping and all components of the system shall be examined for corrosion, deterioration and for any modification affecting compliance with this Standard, at least once in a year or in case of malfunction or accident. The inspection shall include leak testing

NOTE: Every NG/CNG /LPG Genset manufacturer shall incorporate periodic inspection schedules in the operation and owner's manuals.

7.4 Leak Test

7.4.1 Initial Test

At the time of commissioning, the complete pressure system shall be subjected to a pressure test of 20 ± 1 MPa by using CNG or pressure of NG/LPG or a gas inert to NG/LPG such as Nitrogen.

Procedure:

- a) With vapor sealing removed from cylinder valve area, and cylinder valve closed slowly pressurize the system.

WARNING. The system must not be subjected to a shock loading as insecure fittings could blow out with dangerous results, and burst discs could rupture.

- b) Leak test lines, fittings and components using a non-corrosive foaming agent and when leak free.
- c) Open valve, pressurize system and check for leaks at valve and all joints.
- d) When the system is passed leak free seal venting area.

7.4.2 Where CNG/PNG/LPG is used for testing, the following precautions shall be observed:

- a) Testing shall be carried out under adequately vented conditions.
- b) Testing shall be carried out at least 5 m from any open flame or other source of ignition.

7.4.3 The operation of the equipment and controls shall also be tested with PNG/CNG/LPG under normal working conditions to prove satisfactory performance of the entire system and a further leak test shall be carried out using a non- corrosive foaming agent.

7.4.4 BCF fire extinguisher and dry powder fire extinguisher conforming to IS 2171 and each of 5 kg shall be kept ready within a safe distance. If ignition occurs the service valve should be closed and the extinguisher(s) used to quell any fire, which may continue.

7.5 Repair of NG/LPG System

7.5.1 Repairing of NG/LPG System

- a) There shall be no leaks in the fuel system
- b) There shall not be any ignition source within 3 m
- c) CNG/PNG/LPG fueled engines being repaired, unless the fuel is required for engine operation, shall have the shut-off valve closed and the CNG/PNG/LPG fuel in the service line exhausted by running the engine or depressurizing the line in a well-ventilated area
- d) Such NG Gensets undergoing repairs involving welding or the application of heat, to any part within 1 m of the cylinder/PNG connection, shielded from the source of heat.

7.5.2 Repair Operation

- a) Repair operation involving heat shall be carried out with due regard to fire safety.
- b) Damaged fuel lines shall not be repaired; in all cases they shall be replaced.
- c) Welding, brazing and the application of heat shall not be carried out on any part of the cylinder/PNG line subsequent to manufacture.

7.6 Scrapping of Cylinder

- 7.6.1 A Cylinder of Genset, which is about to be scrapped, shall have its cylinder removed prior to disposal.
- 7.6.2 Where the cylinder has been subjected to impact or fire damage the cylinder shall be inspected and re-tested by the owner of the Genset as per Gas Cylinder Rules, 2016, as amended from time to time.

NOTE: There will always be combustible gas in the cylinder until it has been cleared of all traces of flammable vapour or gas.

8. STATUTORY AUTHORITY APPROVAL

The type of component in question and its use determine the Statutory Authority Approval in respect of CNG/PNG/LPG fuel system components for Genset application. The Statutory areas of responsibility are:

Government Agency	Statutory powers	Scope of application
Ministry of Environment and Forest, Government of India. (MoEF) Central Pollution Control Board (CPCB) Test Agencies as notified by CPCB	Environment (P) Act 1986	All CNG/LPG kit components (excluding CNG/LPG cylinder & its valve(s)) and systems used for Genset application.
Petroleum and Explosive safety Organization (PESO), Government of India	Gas Cylinder Rules	CNG/LPG cylinder with valves and their accessories.
Ministry of Petroleum & Natural Gas (MoPNG) or CGD Company approved by PNGRB/MoPNG.	Petroleum Act	PNG Pipeline & its joints / connection

9. TYPE APPROVAL ADMINISTRATIVE PROCEDURE

9.1 Selection of Certifying Agency

9.1.1 Following test agencies are currently approved by the Nodal Agency Central Pollution Control Board (CPCB) for purpose of type approval and subsequently conformity of production compliance process and may be revised from time to time.

- a) Automotive Research Association of India (ARAI, Pune)
- b) International Centre for Automotive Testing (ICAT, Manesar)
- c) Indian Institute of Petroleum (IIP, Dehradun)
- d) Indian Oil Corporation Research and Development Centre (IOCL R&D, Faridabad).

9.1.2 One supplier shall submit application for Type Approval to only one certification agency for all its families / models out of those approved.

9.1.3 The same certification agency shall be responsible for carrying out the verification of Conformity of Production (COP) for that manufacture

9.1.4 For a new OEM or importer, selection of technical agencies for type approval certification and subsequently conformity of production shall be applicant's choice among the technical agencies published by central pollution control board (CPCB) and as amended from time to time.

9.1.5 For any reason if any manufacturer wants to change the certification agency, he shall apply to the nodal agency well in advance with justifiable reason. The nodal agency, after consultation with the existing certification agency/ standing committee, may approve the change, if found justified. If approved, the nodal agency shall inform to the parties concerned.

9.1.6 On receipt of information for change in certification agency from the nodal agency, the previous certification agency shall authenticate all the relevant document of the model (type approval as well as COP verification) and forward the same to the new certification agency. The certification agency shall be responsible for carrying out the type approval testing and COP verification for the manufacturer, in future.

9.2 Application of type approval

- 9.2.1 To apply for the safety type approval of the Genset, the engine should be certified for emission compliance first.
- 9.2.2 The noise certificate shall be granted to supplier once the safety certification is accomplished.
- 9.2.3 The application shall be made in the format prescribed in this document and must be complete in all respect.
- 9.2.4 For each engine family, the manufacturer must submit, an application to the certification agency.
- 9.2.5 The application must be signed by the authorized representative of the manufacturer.
- 9.2.6 It shall be accompanied by the undermentioned documents and the following particulars:
- 9.2.7 A description of the engine type comprising the particulars and all the necessary documents related to engine certification, fuel system test reports, Genset layout, etc. For the purpose of identification, the manufacturer shall designate the engines families as F1, F2, F3 Fn in consultation with technical agency;
- 9.2.8 The Testing agency shall intimate its decision to the applicant within a fortnight of receipt of the application, indicating need and plan (schedule) of testing for type approval.

9.3 Type Approval

- 9.3.1 No person or agency shall sale, import or use an engine for Genset application in India without valid Type Approval Certificate and Conformity of production Certificate
- 9.3.2 No person or agency shall sale, import or use a Genset in India containing an Engine without valid Type Approval Certificate and Conformity of production Certificate
- 9.3.3 The manufacturer may use of commercial fuels or reference fuels, provided to be declared in the information document.
- 9.3.4 Additionally, in order to receive type approval of a Genset with an approved engine with regard to emissions or a type approval of a Genset with regard to emissions the manufacturer shall ensure compliance with the installation requirements.

9.4 Certificate of Type Approval and Validity

- 9.4.1 After verification of engine(s) for the type approval, the technical agency shall issue a type approval report to manufacturer within one month from date of testing completion indicating acceptance or rejection decision and reason thereof.
- 9.4.2 The certificate shall be deemed to be valid for the model(s) included herein, unless explicitly withdrawn by separate written order by the Nodal Agency;
- 9.4.3 The Type Approval certificate for an engine family issued to the manufacturer shall be valid for the same model(s) manufactured at any other manufacturing plant of the same manufacturer. The Nodal Agency or technical agency concern with type approval may visit the new plant to verify adequacy of the infrastructure;
- 9.4.4 Validity of Type Approval Certificate issued by type approval authority shall remain valid further as long as following conditions are met:
- a) Till the engine specifications unchanged
 - b) Till the further amendments to the notification;

9.5 Modification and Extensions of approved type

- 9.5.1 If an engine type or engine family is type approved and valid, manufacturer may approach type approval certificate issuing technical agency for modifications pertaining to parent or any engine type in the certified engine emissions family. Such modifications shall be ascertained by manufacturer utilizing defined guidelines.
- 9.5.2 Manufacturer shall submit technical document in line with type approval procedure prescribed in this Regulation;
- 9.5.3 Subjected to scrutiny of manufacture's application, technical agency shall approve or seek more data pertaining but not limited to engine architecture, parameters, similarity with existing engine type from emissions and performance perspective along with evidences. Decision of technical agency will remain finally binding for allowing such amendments to existing type approval certificate of an engine family through extension(s) vs asking manufacturer to type approve as new engine family or new engine type;
- 9.5.4 Technical agency retains all rights to ask manufacture to demonstrate modified engine type for emissions conformity through applicable type approval test procedures. Submission of

manufacturer run emissions data with valid test facility and procedure followed is mandatory where changes are directly or indirectly pertaining to emission affecting components, engine and after treatment system control algorithms and engine performance specifications.

9.6 Type Approval Process

Genset to be certified as per safety code of practice as defined in this document at the time of applying for Type Approval of NVH certification. NVH TA certificate shall be issued only after successful completion of safety code of practice certification of the Genset.

Following are the logical steps for the type approval process flow chart described in brief stepwise -

- a) Application to nodal agency (CPCB) in the form of affidavit seeking permission for type approval of Genset engine family through submission provided as draft specimen.
- b) Upon written approval of nodal agency to manufacturer and chosen technical agency; (This could be decision making node with “Yes” / “No” loop).
- c) Submit type approval certification application to chosen test agency. Based on provisions such application can be written or online through their secured portal.
- d) Obtain technical agency approval (This could be decision making node with “Yes” / “No” loop with NO means, provide additional data).
- e) Upon agencies application scrutiny and negotiations, submit detailed technical documentation as per requirements described in Annexure 1.
- f) Obtain documentation approval from technical agency
- g) Obtain test plan / schedule from technical agency.
- h) Upon approval from technical agency plan for safety procedural demonstration.
- i) Review of all test results with manufactures and decision about compliance, in case of failure manufacture to follow guidelines provided by test agency.
- j) Technical agency carries out part verification of critical engine components, CNG/LPG/NG components, safety layout with document submission, take final review of technical document and ask manufacture to resubmit if necessary.
- k) Manufacture submit the corrected technical document if found necessary.
- l) Examine corrected document submitted in line with the requirement.
- m) Technical agency prepares technical report based on the observations.
- n) Technical agency gives clearance to NVH for issuing the NVH certificate.

APPENDIX A.1

Template for submission of engine technical specification (Template for information document)

PART A

1. GENERAL INFORMATION

- 1.1. Make (trade name(s) of manufacturer):
- 1.2. Commercial /Brand Name name(s) (if applicable):
- 1.3. Company name and address of manufacturer:
- 1.4. Name and address of manufacturer's authorized representative (if any):
- 1.5. Name(s) and address(es) of assembly/manufacture plant(s):
- 1.6. Engine type designation/engine family designation/FT:
- 1.7. Category Constant speed or variable speed:
- 1.8. Rated Power

PART B

2. COMMON DESIGN PARAMETERS OF ENGINE FAMILY (1)

- 2.1. Combustion Cycle: four stroke cycle/two stroke cycle/other (specify):
- 2.2. Ignition Type: Compression ignition / Spark Ignition
- 2.3. Configuration of the cylinders:
 - 2.3.1. Position of the cylinders in the block: Single/V/in-line/opposed/radial/ other(specify):
 - 2.3.2. Bore center to center dimension (mm):
- 2.4. Combustion chamber type/design
 - 2.4.1. Open chamber/divided chamber/other(specify):
 - 2.4.2. Valve and porting configuration:
 - 2.4.3. Number of valves per cylinder:
- 2.5. Range of swept volume per cylinder (cm³):
- 2.6. Main Cooling medium: Air/Water/Oil:
- 2.7. Method of air aspiration: naturally aspirated/pressure charged/pressure charged with charge cooler:
- 2.8. Fuel:
 - 2.8.1. Fuel Type: Diesel / Gasoline/ CNG/ LPG
 - 2.8.1.1. Reserved.
 - 2.8.2. Fueling arrangement: Dual-fuel type 1A/Dual-fuel type 1B/Dual-fuel type 2A/Dual-fuel type 2B/Dual-fuel type 3B
 - 2.8.3. List of additional fuels, fuel mixtures or emulsions compatible with use by the engine declared by the manufacturer (provide reference to recognized standard or specification):
 - 2.8.4. Lubricant added to fuel: Yes/No

- 2.8.5. Fuel supply type: Pump (high pressure) line and injector/in-line pump or distributor pump/Unit injector/ Common rail.
- 2.9. Engine management systems: mechanical/electronic control strategy
- 2.10. Miscellaneous devices: Yes/No (if yes provide a schematic diagram of the location and order of the devices)
 - 2.10.1. Exhaust gas recirculation (EGR): Yes/No (if yes, complete section 3.10.1 and provide a schematic diagram of the location and order of the devices)
 - 2.10.2. Water injection: Yes/No (if yes, complete section 3.10.2 and provide a schematic diagram of the location and order of the devices)
 - 2.10.3. Air injection: Yes/No (if yes, complete section 3.10.3 and provide a schematic diagram of the location and order of the devices)
 - 2.10.4. Others: Yes/No (if yes specify, complete section 3.10.4 and provide a schematic diagram of the location and order of the devices):
- 2.11. Exhaust after-treatment system: Yes/No (if yes provide a schematic diagram of the location and order of the devices)
 - 2.11.1. Oxidation catalyst: Yes/No
(if yes, complete section 3.11.2)
 - 2.11.2. De NOX system with selective reduction of NOX (addition of reducing agent): Yes/No
(if yes, complete section 3.11.3)
 - 2.11.3. Other De NOX systems: Yes/No
(if yes, complete section 3.11.3)
 - 2.11.4. Reserved
 - 2.11.5. Particulate after-treatment system with passive regeneration: Yes/No
(if yes, complete section 3.11.4)
 - 2.11.5.1. Wall-flow/non-wall-flow
 - 2.11.6. Particulate after-treatment system with active regeneration: Yes/No
(if yes, complete section 3.11.4)
 - 2.11.6.1. Wall-flow/non-wall-flow
 - 2.11.7. Other particulate after-treatment systems: Yes/No
(if yes, complete section 3.11.4)
 - 2.11.8. Other after-treatment devices (specify):
(if yes, complete section 3.11.5)
 - 2.11.9. Other devices or features that have a strong influence on emissions Yes/No (specify):
(if yes, complete section 3.11.7)

PART C

Item Number	Item Description	Parent engine/ engine type	Engine types within the engine family (if applicable)				Explanatory notes (not included in document)
			type 2	type 3	type ...	type n	
3.1	Engine Identification						
3.1.1	Engine type designation						
3.1.2	Engine type designation shown on engine marking: yes/no						
3.1.3	Location of the statutory marking:						
3.1.4	Method of attachment of the statutory marking:						
3.1.5	Drawings of the location of the engine identification number (complete example with dimensions):						
3.2	Performance Parameters						
3.2.1	Declared rated speed(s) (rpm):						
3.2.1.1	Declared rated gross power (kW):						
3.2.1.2	Fuel delivery/stroke (mm ³) for diesel engine, fuel flow (g/h), at rated gross power						
3.2.6	Idle speed (rpm)						
3.2.7	No load speed (rpm):						
3.2.8	Overload load speed (rpm):						
3.3	Run-in procedure						Optional at choice of manufacturer
3.3.1	Run-in time:						
3.3.2	Run-in cycle:						
3.4	Engine test						
3.4.1	Specific fixture required: Yes/No						For NRSh only
3.4.1.1	Description, including photographs and/or drawings, of the system for mounting the engine on the test bench including the power transmission shaft for connection to the dynamometer:						
3.4.2	Exhaust mixing chamber permitted by manufacturer: Yes/No						For NRSh only
3.4.2.1	Exhaust mixing chamber description, photograph and/or drawing:						If applicable

Item Number	Item Description	Parent engine/ engine type	Engine types within the engine family (if applicable)				Explanatory notes (not included in document)
			type 2	type 3	type ...	type n	
3.4.3	Pre-conditioning for: Steady-state operation						
3.5	Lubrication system						
3.5.1	Lubricant temperature						If applicable
3.5.1.1	Minimum (°C):						
3.5.1.2	Maximum (°C):						
3.6	Combustion Cylinder						
3.6.1	Bore(mm):						
3.6.2	Stroke(mm):						
3.6.3	Number of cylinders:						
3.6.4	Engine total swept volume (cm ³):						
3.6.5	Swept volume per cylinder as % of parent engine:						If engine family
3.6.6	Volumetric compression ratio:						Specify tolerance
3.6.7	Combustion system description:						
3.6.8	Drawings of combustion chamber and piston crown:						
3.6.9	Minimum cross-sectional area of inlet and outlet ports (mm ²):						
3.6.10	Valve timing						
3.6.10.1	Maximum lift and angles of opening and closing in relation to dead center or equivalent data:						
3.6.10.2	Reference and/or setting range:						
3.6.10.3	Variable valve timing system: Yes/No						If applicable and where intake and/or exhaust
3.6.10.3.1	Type: continuous/(on/off)						
3.6.10.3.2	Cam phase shift angle:						
3.6.11	Porting configuration						2-stroke only, if applicable
3.6.11.1	Position, size and number:						
3.7	Cooling system						Complete relevant section
3.7.1	Liquid cooling						
3.7.1.1	Nature of liquid:						
3.7.1.2	Circulating pumps: Yes/No						
3.7.1.2.1	type(s):						
3.7.1.2.2	Drive ratio(s):						If applicable
3.7.1.3	Minimum coolant temperature at outlet (°C):						

Item Number	Item Description	Parent engine/ engine type	Engine types within the engine family (if applicable)				Explanatory notes (not included in document)
			type 2	type 3	type ...	type n	
3.7.1.4	Maximum coolant temperature at outlet (°C):						
3.7.2	Reserved						
3.8	Aspiration						
3.8.1	Maximum allowable intake depression at rated engine speed and at 100% load (kPa)						
3.8.1.1	With clean air cleaner:						
3.8.1.2	With dirty air cleaner:						
3.8.1.3	Location, of measurement:						
3.8.2	Pressure charger(s): Yes/No						
3.8.2.1	Type(s):						
3.8.2.2	Description and schematic diagram of the system (e.g. maximum charge pressure, waste gate, VGT, Twin turbo, etc.):						
3.8.3	Charge air cooler: Yes/No						
3.8.3.1	Type: air-air/air-water/other(specify)						
3.8.3.2	Maximum charge air cooler outlet temperature at rated speed and 100% load (°C):						
3.8.3.3	Maximum allowable pressure-drop across charge cooler at rated engine speed and at 100% load (kPa):						
3.8.4	Intake throttle valve: Yes/No						
3.8.5	Device for recycling crankcase gases: Yes/No						
3.8.5.1	If yes, description and drawings:						
3.8.5.2	If no, compliance with paragraph 5.7. of this Regulation: Yes/No						
3.9	Exhaust system						
3.9.1	Description of the exhaust system (with drawings, photos and/or part numbers as required):						
3.9.2	Maximum exhaust temperature (°C):						

Item Number	Item Description	Parent engine/ engine type	Engine types within the engine family (if applicable)				Explanatory notes (not included in document)
			type 2	type 3	type ...	type n	
3.9.3	Maximum permissible exhaust backpressure at rated engine speed and at 100% load (kPa):						
3.9.3.1	Location of measurement:						
3.9.4	Exhaust backpressure at loading level specified by manufacturer for variable restriction after-treatment at start of test (kPa):						
3.9.4.1	Location and speed/load conditions:						
3.9.5	Exhaust throttle valve: Yes/No						
3.10	Miscellaneous devices: Yes/No						
3.10.1	Exhaust gas recirculation (EGR)						
3.10.1.1	Characteristics: cooled/uncooled, high pressure/low pressure/other (specify):						
3.10.2	Water injection						
3.10.2.1	Operation principle:						
3.10.3	Air injection						
3.10.3.1	Operation principle						
3.10.4	Others						
3.10.4.1	Type(s)						
3.11	Exhaust after-treatment system						
3.11.1	Location						
3.11.1.1	Place(s) and maximum/minimum distance(s) from engine to first after-treatment device:						
3.11.1.2	Maximum temperature drops from exhaust or turbine outlet to first after-treatment device (°C) if stated:						
3.11.1.2.1	Test conditions for measurement:						
3.11.1.3	Minimum temperature at inlet to first after-treatment device, (°C) if stated:						
3.11.1.3.1	Test conditions for measurement:						
3.11.2	Oxidation catalyst						
3.11.2.1	Number of catalytic converters and elements:						

Item Number	Item Description	Parent engine/ engine type	Engine types within the engine family (if applicable)				Explanatory notes (not included in document)
			type 2	type 3	type ...	type n	
3.11.2.2	Dimensions and volume of the catalytic converter(s):						Or drawing
3.11.2.3	Total charge of precious metals (g):						
3.11.2.4	Relative concentration of each compound (%):						
3.11.2.5	Substrate (structure and material):						
3.11.2.6	Cell density:						
3.11.2.7	Type of casing for the catalytic converter(s):						
3.11.3	Catalytic exhaust after-treatment system for NOX or three-way catalyst						
3.11.3.1	Type:						
3.11.3.2	Number of catalytic converters and elements:						
3.11.3.3	Type of catalytic action:						
3.11.3.4	Dimensions and volume of the catalytic converter(s):						Or drawing
3.11.3.5	Total charge of precious metals (g):						
3.11.3.6	Relative concentration of each compound (%):						
3.11.3.7	Substrate (structure and material):						
3.11.3.8	Cell density:						
3.11.3.9	Type of casing for the catalytic converter(s):						
3.11.3.10	Method of regeneration:						If applicable
3.11.3.10.1	Infrequent regeneration: Yes/No:						If yes, complete section 3.11.6.
3.11.3.11	Normal operating temperature range (°C):						
3.11.3.12	Consumable reagent: Yes/No						
3.11.3.12.1	Type and concentration of reagent needed for catalytic action:						
3.11.3.12.2	Lowest concentration of the active ingredient presents in the reagent that does not activate warning system (CDmin) (%vol):						

Item Number	Item Description	Parent engine/ engine type	Engine types within the engine family (if applicable)				Explanatory notes (not included in document)
			type 2	type 3	type ...	type n	
3.11.3.12.3	Normal operational temperature range of reagent:						
3.11.3.12.4	International standard:						If applicable
3.11.3.13	NOX sensor(s): Yes/No						
3.11.3.13.1	Type:						
3.11.3.13.2	Location(s)						
3.11.3.14	Oxygen sensor(s): Yes/No						
3.11.3.14.1	Type:						
3.11.3.14.2	Location(s):						
3.11.4	Particulate after-treatment system						
3.11.4.1	Type of filtration: wall-flow/ non-wall-flow/other (specify)						
3.11.4.2	Type:						
3.11.4.3	Dimensions and capacity of the particulate after-treatment system:						Or drawing
3.11.4.4	Location place(s) and maximum and minimum distance(s) from engine:						
3.11.4.5	Method or system of regeneration, description and/or drawing:						
3.11.4.5.1	Infrequent regeneration: Yes/No						If yes, complete section 3.11.6.
3.11.4.5.2	Minimum exhaust gas temperature for initiating regeneration procedure (°C):						
3.11.4.6	Catalytic coating: Yes/No						
3.11.4.6.1	Type of catalytic action:						
3.11.4.7	Fuel borne catalyst (FBC): Yes/No						
3.11.4.8	Normal operating temperature range (°C):						
3.11.4.9	Normal operating pressure range (kPa)						
3.11.4.10	Storage capacity soot/ash (g):						
3.11.4.11	Oxygen sensor(s): Yes/No						

Item Number	Item Description	Parent engine/ engine type	Engine types within the engine family (if applicable)				Explanatory notes (not included in document)
			type 2	type 3	type ...	type n	
3.11.4.11.1	Type:						
3.11.4.11.2	Location(s):						
3.11.5	Other after-treatment devices						
3.11.5.1	Description and operation:						
3.11.6	Infrequent Regeneration						
3.11.6.1	Number of cycles with regeneration						
3.11.6.2	Number of cycles without regeneration						
3.11.7	Other devices or features						
3.11.7.1	Type(s)						
3.12	Fuel feed for liquid-fuelled CI or, where applicable, dual-fuel engines						
3.12.1	Feed pump						
3.12.1.1	Pressure (kPa) or characteristic diagram:						
3.12.2	Injection system						
3.12.2.1	Fuel Pump						
3.12.2.1.1	Type(s):						
3.12.2.1.2	Rated pump speed (rpm):						
3.12.2.1.3	mm ³ per stroke or cycle at full injection at rated pump speed:						Specify tolerance
3.12.2.1.4	Reserved						
3.12.2.1.5	Reserved						Specify tolerance
3.12.2.1.6	Characteristic diagram:						As alternative to entries 3.12.2.1.1. to 3.12.2.1.5.
3.12.2.1.7	Method used: on engine/on pump bench						
3.12.2.2	Injection timing						
3.12.2.2.1	Injection timing curve:						Specify tolerance, if applicable
3.12.2.2.2	Static Timing:						Specify tolerance
3.12.2.3	Injection piping						
3.12.2.3.1	Length(s) (mm):						
3.12.2.3.2	Internal diameter (mm):						
3.12.2.4	Common rail: Yes/No						
3.12.2.4.1	Type:						
3.12.3	Injector(s)						

Item Number	Item Description	Parent engine/ engine type	Engine types within the engine family (if applicable)				Explanatory notes (not included in document)
			type 2	type 3	type ...	type n	
3.12.3.1	Type(s):						
3.12.3.2	Opening pressure (kPa):						Specify tolerance
3.12.4	ECU: Yes/No						
3.12.4.1	Type(s):						
3.12.4.2	Software calibration number(s):						
3.12.4.3	Communication standard(s) for access to data stream information: ISO 27145 with ISO 15765-4 (CAN-based)/ISO 27145 with ISO 13400 (TCP/IP-based)/SAE J1939-73						
3.12.5	Governor						
3.12.5.1	Type(s):						
3.12.5.2	Speed at which cut-off starts under full load:						Specify range, if applicable
3.12.5.3	Maximum no-load speed:						Specify range, if applicable
3.12.5.4	Idle speed:						Specify range, if applicable
3.12.6	Cold-start system: Yes/No						
3.12.6.1	Type(s):						
3.12.6.2	Description:						
3.12.7	Fuel temperature at the inlet to the fuel injection pump						
3.12.7.1	Minimum (°C):						
3.12.7.2	Maximum (°C):						
3.13	Reserved						
3.14.	Fuel feed for gaseous fuel engines or where applicable, dual-fuel engines (in the case of systems laid out in a different manner, supply equivalent information) (Need to check if something missed out)						
3.14.1.	Fuel: LPG /NG-H/NG-L /NG-HL/LPG						
3.14.2.	Pressure regulator(s)/vaporizer(s)						
3.14.2.1.	Type(s)						
3.14.2.2.	Number of pressure reduction stages						

Item Number	Item Description	Parent engine/ engine type	Engine types within the engine family (if applicable)				Explanatory notes (not included in document)
			type 2	type 3	type ...	type n	
3.14.2.3.	Pressure in final stage minimum and maximum. (kPa)						
3.14.2.4.	Number of main adjustment points:						
3.14.2.5.	Number of idle adjustment points:						
3.14.3.	Fuelling system: mixing unit/gas injection/liquid injection/direct injection						
3.14.3.1.	Mixture strength regulation						
3.14.3.1.1.	System description and/or diagram and drawings:						
3.14.4.	Mixing unit						
3.14.4.1.	Number:						
3.14.4.2.	Type(s):						
3.14.4.3.	Location:						
3.14.4.4.	Adjustment possibilities:						
3.14.5.	Inlet manifold injection						
3.14.5.1.	Injection: single-point/multi-point						
3.14.5.2.	Injection: continuous/simultaneously timed/ sequentially timed						
3.14.5.3.	Injection equipment						
3.14.5.3.1.	Type(s):						
3.14.5.3.2.	Adjustment possibilities:						
3.14.5.4.	Supply pump						If applicable
3.14.5.4.1.	Type(s):						
3.14.5.5.	Injector(s)						
3.14.5.5.1.	Type(s):						
3.14.6.	Direct injection						
3.14.6.1.	Injection pump/pressure regulator						
3.14.6.1.1.	Type(s):						
3.14.6.1.2.	Injection timing (specify):						
3.14.6.2.	Injector(s)						
3.14.6.2.1.	Type(s):						
3.14.6.2.2.	Opening pressure or characteristic diagram:						
3.14.7.	Electronic Control Unit (ECU)						
3.14.7.1.	Type(s):						
3.14.7.2.	Adjustment possibilities:						
3.14.7.3.	Software calibration number(s):						

Item Number	Item Description	Parent engine/ engine type	Engine types within the engine family (if applicable)				Explanatory notes (not included in document)
			type 2	type 3	type ...	type n	
3.14.8.	Approvals of engines for several fuel compositions						
3.14.8.1.	Self-adaptive feature: Yes/No						
3.14.8.2.	Calibration for a specific gas composition: NG-H/NG-L/NG-HL/ LNG/Fuel specific LNG						
3.14.8.3.	Transformation for a specific gas composition: NG-HT/NG-LT/NG-HLT						
3.14.9.	Fuel temperature pressure regulator final stage						
3.14.9.1.	Minimum (°C):						
3.14.9.2.	Maximum (°C):						
3.15.	Ignition system						
3.15.1.	Ignition coil(s)						
3.15.1.1.	Type(s):						
3.15.1.2.	Number:						
3.15.2.	Spark plug(s)						
3.15.2.1.	Type(s):						
3.15.2.2.	Gap setting:						
3.15.3.	Magneto						
3.15.3.1.	Type(s):						
3.15.4.	Ignition timing control: Yes/No						
3.15.4.1.	Static advance with respect to top dead center (crank angle degrees):						
3.15.4.2.	Advance curve or map:						If applicable
3.15.4.3.	Electronic control: Yes/No						

Part D – For Gaseous Fuel System

1. Details of Kit Manufacturer / Supplier / Installer	
a) Name of the Manufacturer	
b) Address	
c) Telephone No. & Fax No.	
2. Gas Kit Identification	
a) Identification No.	
b) Variants, if any	
c) Fuel system (Dedicated / Bi-Fuel / Dual Fuel / Dedicated Dual Fuel)	

d) Type of Dual- fuel system (Type 1A / 1B / 2A / 2B / 3B)	
e) Fuel (Gas Fuel (Specify Name of fuel))	
3. Solenoid Valve / Automatic shutoff valve	
a) Name of manufacturer	
b) Model Name / Identification No.	
c) Type	
d) Working pressure (kg/cm ²)	
e) Max test pressure (kg/cm ²)	
f) Approval reference (Test Report / Approval Number)	
4. High Pressure Regulator	
a) Name of manufacturer	
b) Model name / Identification No.	
c) Type	
d) Inlet pressure (kg/cm ²)	
e) Outlet pressure (kg/cm ²)	
f) No. of stages	
g) Approval reference (Test Report / TAC compliance with Date)	
5. Low Pressure Regulator	
a) Name of manufacturer	
b) Model name / Identification No.	
c) Type	
d) Inlet pressure (kg/cm ²)	
e) Outlet pressure (kg/cm ²)	
f) No. of stages	
g) Approval reference (Test Report / TAC compliance with Date)	
6. Zero Pressure Regulator	
a) Name of manufacturer	
b) Model name / Identification No.	
c) Type	
d) Inlet pressure (kg/cm ²)	
e) Outlet pressure (kg/cm ²)	
f) Approval reference (Test Report / TAC compliance with Date)	
7. Vaporizer / Heat exchanger (for LNG)	
a) Name of manufacturer	
b) Model name / Identification No.	
c) Type	

d) Inlet pressure (kg/cm ²)	
e) Outlet pressure (kg/cm ²)	
f) Approval reference (Test Report / Approval Number)	
8. Filter	
a) Name of manufacturer	
b) Model name / Identification No.	
c) Type	
d) Inlet pressure (kg/cm ²)	
e) Outlet pressure (kg/cm ²)	
9. High Pressure Tubing	
a) Name of manufacturer	
b) Model name / Identification No.	
c) Type (rigid / flexible)	
d) Working pressure (kg/cm ²)	
e) Max. test pressure (kg/cm ²)	
f) Outer diameter / Inner Diameter (mm)	
g) Material	
h) Approval reference (Test Report / Approval Number)	
10. Low Pressure Tubing	
a) Name of manufacturer	
b) Model name / Identification No.	
c) Type	
d) Working pressure (kg/cm ²)	
e) Max test pressure (kg/cm ²)	
f) Outer diameter / Inner Diameter (mm)	
g) Material	
h) Approval reference (Test Report / Approval Number)	
11. Gas-Air Mixer	
a) Name of manufacturer	
b) Model name / Identification No	
c) Type & drawing	
d) Venturi Size (mm)	
e) Approval reference (Test Report / Approval Number)	
12. Gas Injector	
a) Name of manufacturer	
b) Model name / Identification No	
c) Type & drawing	

d) Injector flow specs	
e) Approval reference (Test Report / Approval Number)	
13. Wiring Harness	
a) Name of manufacturer	
b) Electrical circuit diagram / Detail layout	
c) Approval reference (Test Report / Approval Number)	
14. Interfacing Unit (ECU)	
a) Name of manufacturer	
b) Identification No.	
c) Type	
15. Fuel selector switch	
a) Name of manufacturer	
b) Model No	
c) Type	
16. Fuel flow actuation mechanism (Mechanical / Electronic)	
a) Brief description of system (Attach Annexure)	
b) Schematic layout (Attach Drawing)	
c) Identification of critical components of Kit, including ECU, Lambda sensor, Pressure sensor, temperature Sensor etc. with Make and Identification number) (attach Annexure)	
17. Brief Description of System Including Dimensional Layout for kit components installation ventilation details etc.	
18. Joints and connections	
a) Name of manufacturer	
b) Type	
c) Number of Joints and connections represented on Drawing (Attach Drawing)	
19. Current limiting Device (Fuse)	
a) Name of manufacturer	
b) Identification No.	
c) Voltage / current rating	
d) Type	
e) Approval reference (Test Report / Approval Number)	
20. Indicator	
A. Pressure Indicator	

a) Name of manufacturer	
b) Identification No.	
c) Type	
B. Temperature Indicator (for LNG)	
a) Name of manufacturer	
b) Identification No.	
c) Type	
21. Service shut off valve	
a) Name of manufacturer	
b) Identification No.	
c) Type	
22. Compartment/Sub-compartment / Gas tight housing	
a) Name of manufacturer	
b) Identification No	
c) Type	
d) Material used	
e) Approval reference (Test Report / Approval Number)	
23. Conduit	
a) Name of manufacturer	
b) Identification No.	
c) Inner & outer diameter	
d) Type	
e) Approval reference (Test Report / Approval Number)	
24. Battery cut off switch (if applicable)	
a) Name of manufacturer	
b) Identification No.	
c) Type	
25. Labels - Number and position	
26. Any other information	
* Mention NA wherever not applicable	

Part E
Gaseous Fuel Safety Component – Test Applicability

Sr. No.	Gas Kit Component	Certifying / Verifying Authority	Applicable Standards
1	Regulator (For CNG & BIO-CNG) / Regulator and Vaporizer (LNG)*	Testing of the component as per IS: 15713 or ISO-15500 by test agency. Alternatively, test agency to verify the test certificate or report conforming to the above standard issued by accredited testing laboratory.	IS: 15713 or ISO -15500

		LNG regulator and Vaporizer / heat exchanger shall meet requirements of UN R110 or equivalent standard	UN R 110 or equivalent standard
2	Gas-Air Mixer*	Testing of the component as per IS: 15714 or ISO-15500 by test agency. Alternatively, test agency to verify the test certificate or report conforming to the above standard issued by accredited testing laboratory.	IS: 15714 or ISO-15500
3	Gas Injector*	Testing of the component as per ISO-15500-7 by test agency. Alternatively, test agency to verify the test certificate or report conforming to the above standard issued by accredited testing laboratory.	ISO-15500-7
4	Gas Solenoid Valve / Automatic Shutoff valve*	Testing of the component as per IS: 15712 or ISO-15500 by test agency. Alternatively, test agency to verify the test certificate or report conforming to the above standard issued by accredited testing laboratory.	IS: 15712 or ISO-15500
		Automatic shutoff valve of LNG System (which comes in contact with LNG shall meet requirements of UN R110 or equivalent standards)	Automatic shutoff Valve for LNG System: UN R110 or equivalent standards
5	Testing of Conduit*	Testing of the component or verification of certificate or test report as per IS: 15715 by test agency.	IS: 15715
6	CNG / BIO-CNG / LNG fuel line		
6.1	High pressure exceeding 100 kPa*		
6.1.1	Exceeding 2.15 MPa		
	Rigid pipe	Testing of the component or verification of certificate or test report as per IS: 15716 by test agency.	IS: 15716
		LNG rigid pipeline shall meet requirements of UN R 110 or IS: 15716 or equivalent standard.	UN R 110 or IS: 15716 or equivalent standard.
	Flexible hose	Testing of the component or verification of certificate or test report as per IS 15718 by test agency.	IS 15718 or AIS-028 (Rev. 1) (Part A)
		LNG flexible pipeline shall meet requirements of UN R110 or IS: 15718 or equivalent standard.	UN R 110 or IS: 15718 or equivalent standard

6.1.2	Pressure up to 2.15 Bar	Testing of the component or verification of certificate or test report as per IS: 15722 by test agency.	IS: 15722 with amendments
		LNG pipeline shall meet requirements of UN R110 or IS: 15722 or equivalent standard.	UN R 110 or IS: 15722 or equivalent standard
6.2	Joints and connections*	Testing by test agency.	Clause 3.1.4.1, 3.2.1 (b) of AIS-028 (Rev. 1) (Part A)
		LNG joints & connection shall meet requirements of UN R 110 or equivalent standard	UN R 110 or equivalent standard
7	Compartment or Sub-compartment*	Testing of the component or verification of certificate or test report as per IS: 15720 by test agency.	IS: 15720
8	Specific LNG components	Following specific components, as applicable shall meet requirements of UN R 110 or equivalent standard LNG Fuel pump, Pressure Relief valves, Pressure sensor, check valve, excess flow valve, manual valve and non-return valve.	UN R 110 or equivalent standard
9	Safety check for installation of Gaseous fuel system	Safety checks to be carried out by test agency as per AIS-028 (Rev.1) (Part A)	Relevant clauses of AIS-028 (Rev. 1) (Part A)
10	Electrical wiring and harness		AIS 028
11	Non-moisture retaining hard rubber/equivalent material		AIS 028
12	Electrical fuses		AIS 028

* Certificate issued by accredited testing agency of the country of origin or a report issued by internationally accredited test laboratory may also be accepted.

Note 1 - Only the standards, as amended from time to time, as mentioned above, shall be referred for compliance.

Note 2 - Components downstream the Heat exchanger / vaporizer shall be considered as CNG components and prevailing Indian standard / ISO standard or equivalent standards shall be acceptable.

Note 3 - Test agency to conduct applicable CMVR test with LNG fuel as notified by Govt of India.

ANNEXURE - 1

Freezing conditions and corrosive conditions

- 1.1 Where regulator heat is drawn from the engine cooling water, care should be taken to ensure that the water does not freeze in the regulator during cold weather. Expansion of the water on freezing can cause serious damage to the pressure regulator assembly.
- 1.2 Most CNG/PNG/LPG regulators are made from non-ferrous alloys, which can suffer pinhole corrosion under certain conditions. If this is allowed to take place CNG/ PNG/LPG can be admitted to the cooling water system where it will pressurize the radiator and cause a potential hazard. It is important, therefore, to have an effective anticorrosion additive present in the cooling water.
- 1.3 It is important to ensure that the coolant additive and the dilutant ratio comply fully with the engine manufacturer's requirements.

ANNEXURE - 2

Backfire – Deflector tests

- 2.1 A backfire deflector under backfire conditions shall contain a visible flame front within its confines and shall not be displaced, physically damaged or distorted, or show evidence of burning or smoldering of internal parts. If the deflector is of the oil-bath type, it shall be free of any overflow or discharge permitting accumulation of oil on electrical, hot-engine or exhaust system parts.
- 2.2 A complete Genset engine is to be used for this test. Tests are not required on backfire deflectors employed diesel engines.
- 2.3 The backfire deflector (air cleaner, oil-bath or dry element type) and connecting hose are to be removed from the engine. The spark timing is to be advanced (approximately 8 degrees) and the spark plug leads are to be interchanged to obtain sharp backfires under the following conditions. The engine is to be alternately raced and idled and the ignition switch is to be operated to alternately energize and de-energize the ignition system. During the test, the intensity of the backfire and the issuance and extent of the accompanying flame are to be noted.
- 2.4 The backfire deflector (air cleaner) is then to be installed on the truck in the intended location. An oil-bath type deflector (air cleaner) is to be filled to the marked “full level-line” of the bowl. Paper is to be placed beneath the intake orifices of an oil-bath type and over adjacent surfaces of parts likely to be affected by accumulations of oil.
- 2.5 The engine is then to be operated in the several manners determined in the preliminary test to provide for the most severe backfire conditions. At least ten and not more than twenty backfires are to be produced.
- 2.6 Observations for containment of flame are to be made under semi-darkened conditions by at least two observers. No visible flame is to be in evidence at any time during the tests. In the tests of an oil-bath type, paper is not to show evidence of oil deposits in the form of droplets.
- 2.7 A dry-type filter element is to be tested in the above manner, then removed and then subjected to five consecutive washing and drying cycles. Washing is to consist of immersion in plain water together with sufficient agitation to remove bulk material adhering to the outside surface. The test element is then to be remounted as intended in operation, and the backfire test is to be repeated.

2.8 The side of the filter media normally exposed to backfire is then to be subjected to a flame source of sufficient intensity to cause the media to burn or glow. The flame source is then to be removed and an acceptable filter media is not to continue to burn or smolder.

ANNEXURE - 3

Checklist for installation for NG/LPG GENSET

This checklist is a guide for the installer when carrying out the inspection prior to issuing installation Certificate. Reference to relevant clauses in this Standard and guidelines issued by Central Government from time to time should be made where appropriate.

- 3.1 **Cylinder/ PNG connection:** Approved by PESO / CGD Company as applicable Validity of Certificate Free from corrosion Mounted securely
Mounting points free from corrosion and fractures Shielded and valves protected where necessary 5 mm clearance in between cylinders.
- 3.2 **Valves/MFVs:** Approved by PESO / CGD Company as applicable Cylinder valve/MFV operating correctly, burst disc fitted.
- 3.3 **Filling connection:** Refueling connection made external to Genset Engine/Canopy interior Captive dust plug fitted Meets proof loading of 50 kgf.
- 3.4 **Refueling interlock:** Operation corrects
- 3.5 **Non-return valve:** Operation correct free from bypass leakage
- 3.6 **Leak test:** All valves and fittings leak free
- 3.7 **Vapor sealing:** Gas tight
- 3.8 **Ducting:** Free from damage and secure to outlets
- 3.9 **Pliable sub-compartment:** Ease of operation of cylinder valve satisfactory Position identified
- 3.10 **Fuel line:** Free from damage and corrosion Secured to Genset Engine Protected and shielded where necessary
- 3.11 **Joints and connections:** Leak free
- 3.12 **CNG shut off valve/solenoid valve:** Mounting secure Operation Correct Leak free
- 3.13 **Service shut off valve:** Operation satisfactory Mounted Securely Leak Free Identified and operation clearly marked
- 3.14 **Regulator/Vaporizer:** Mounting secure No gas bypass after engine has stopped turning Shielded where necessary Leak free
- 3.15 **Control equipment:** Approved type
- 3.16 **Gas air mixer:** Securely mounted Backfire deflector where applicable
- 3.17 **Bi-fuel /Dual fuel shut-off device:** Operation correct Petrol lock off where fitted is mounted securely Petrol hose secure joints leak free and free from cracks Sufficient flexibility for engine movement Bypass device fitted where applicable

- 3.18 **Electrical wiring:** Current limiting device fitted Connections secure. Terminals insulated to prevent shorting Wiring taped and clipped securely.
- 3.19 **Compliance Plate/label:** Installed and carries correct markings
- 3.20 **Identification labels:** Located front on Genset Engine and Canopy

ANNEXURE -4

Installation certificate for converted CNG/PNG/ LPG GENSET engine manufacturer/ authorized person of genset manufacturer

A. Details of Installer Approval	
1. Installation Certificate issued by	Name and address of Authorized Person
2. Approval details	Name of Genset manufacturer
3. Rating of Genset and its engine	
4. Approval of the CNG /PNG/LPG kit	
a) Name of the Test Agency	
b) Approval Certificate No. & Date	
B. Details of Genset Engines	
1. Sr. No. & year of manufacture	
2. Engine No.	
3. Type of Operation	Bi-fuel / dedicated fuel/Dual fuel
C. Details of CNG/PNG/LPG Kit	
1. Cylinders:	
a) No. of Cylinder/s	
b) Type of Cylinder/s	
c) Cylinder No/s.	
d) Make	
e) Water Capacity (liters)	
f) Working Pressure (kg/cm ²)	
g) Approval reference of PESO	
h) Validity of PESO Certificate	
2. Cylinder CNG/PNG/LPG Valves	
a) Make	
b) Valve No.	
c) Working Pressure (kg/cm ²)	
d) Approval reference of PESO	
3. Refilling Valve:	
a) Make	
b) Type	
4. Fuel Line	
a) High pressure pipe dia (ID/OD)	
b) Low pressure pipe dia (ID/OD)	
5. Shut Off Valve (Solenoid Valves)	
a) Make	
b) Type	
c) Operation Voltage	

6. Fuel selection switch	
a) Make	
b) Type	
7. Regulator/Vaporizer	
a) Make	
b) Type	
c) Sr. No.	
8. Gas-Air Mixer/Injector	
a) Make	
b) Type	
<i>Note: This certificate shall be filled and provided to NG/LPG Genset owner</i>	
Signature & Seal of Installer	

ANNEXURE - 5

Component testing and safety checks for use of NG/CNG fuels in internal combustion engine for generator

No.	CNG Kit Component	Certifying / Verifying Authority	Clause of Safety code of practice / Other Rules, Standards, etc.
1	Cylinder*	PESO, Nagpur to certify or endorse in case of foreign make	Gas cylinder rules, 2016
1.1	Fitment of cylinder	Verify as per Safety Code of practice	Clause no. 5.2 to 5.5 of Safety Code of Practice
2	Cylinder valves*	PESO, Nagpur to certify or endorse in case of foreign make	IS: 3224 or Gas cylinder rules 2016
3	Regulator*	Testing of the component as per IS:15713-2006 or ISO-15500 by test agency. Alternatively, test agency to verify the test certificate or report conforming to the above standard issued by accredited testing laboratory.	IS: 15713-2006 or ISO-15500
4	Gas-Air Mixer* / Injectors	Testing of the component as per S:15714-2006 or ISO-15500 by test Agency. Injectors to be tested as per ECE R110/ISO 15500 Alternatively, test agency to verify the test certificate or report conforming to the above standard issued by accredited testing laboratory.	IS: 15714-2006 or ISO-15500
5	Petrol Solenoid Valve*	Testing of the component as per IS:15717-2006 by test agency. Alternatively, test agency to verify the test certificate or report conforming to the above standard issued by accredited testing laboratory.	IS: 15717-2006
5.1	Gas Solenoid Valve*	Testing of the component as per IS: 15712-2006 or ISO-15500 by test agency. Alternatively, test agency to verify the test certificate or report conforming to the above standard issued by accredited testing laboratory.	IS: 15712-2006 or ISO-15500
6	Filling Connection (NZS & NGV- 1 type) (if Applicable)	Installation to be checked by test agency as per Safety code of practice	Clauses 5.3.2 to 5.3.6 of Safety Code of Practice
7	Ventilation (if Applicable)	Test agency to verify.	5.7.2 of Safety Code of Practice
8	Testing of Conduit* (if Applicable)	Testing of the component or verification of certificate or test report as per IS: 15715-2008 by test agency.	IS: 15715-2008
9	CNG fuel line		

No.	CNG Kit Component	Certifying / Verifying Authority	Clause of Safety code of practice / Other Rules, Standards, etc.
9.1	High pressure exceeding 100 kPa*		
9.1.1	Exceeding 2.15 MPa		
	Rigid pipe	Testing of the component or verification of certificate or test report as per IS: 15716-2006 by test agency.	IS: 15716-2006
	Flexible hose	Testing of the component or verification of certificate or test report as per AIS -028 by test agency.	3.1.3.1, 3.1.3.2 and 3.1.3.3.1 of AIS-028
9.1.2	Exceeding 100 kPa and less than 2.15 MPa	Testing of the component or verification of certificate or test report as per IS: 15722-2006 by test agency.	IS: 15722-2006
9.2	Low pressure – Not exceeding 100 kPa*	Testing of the component or verification of certificate or test report as per IS: 15722-2006 by test agency.	IS: 15722-2006
9.3	Joints and Connections*	Testing by test agency.	Clause 5.8 of Safety Code of Practice
10	Compartment or Sub compartment* (if Applicable)	Testing of the component or verification of certificate or test report as per IS: 15720-2008 by test agency.	IS: 15720-2008
11	Safety check for installation of CNG system	Safety checks to be carried out by test agency as per AIS 028.	Relevant clauses of Safety code of Practice

* Certificate issued by accredited testing agency of the country of origin or a report issued by internationally accredited test laboratory may also be accepted.

Note 1: - Even though all above standards are applicable for automotive applications, considering the use of same or equivalent fuel for Generator application these standards shall be used for CNG components certifications of Generator.

Note 2: - Only the standards, as amended from time to time, as mentioned above, shall be referred for compliance.

Note 3: - Approvals issued prior to implementation of these rules shall be extended for compliance to above requirements without revalidation.

ANNEXURE - 6

Safety checks for use of LPG fuels in internal combustion engine for generator

Sr. No.	LPG Kit Component	Certifying /Verifying Authority	Clause of Safety code of practice / Other Standards, Rules, etc.
1	Cylinder*	PESO, Nagpur to certify or endorse in case of foreign make	Gas cylinder rules, 2016
2	Cylinder valves / Multi-Functional Valve*	PESO, Nagpur to certify or endorse in case of foreign make	Gas cylinder rules, 2016
3	Regulator/Vaporizer *	Regulators which are used to reduce the pressure in LPG installation shall meet the requirements of IS :6044(Part 1) as amended from time to time. Regulator/ Vaporizer which is used to meter Gas for Genset engine shall be Tested as per ECE Regulation No. 67 by test agency. Alternatively, test agency to verify the test certificate or report conforming to the above standard issued by accredited testing laboratory.	IS:6044 (Part 1) ECE Regulation No. 67
4	Gas-Air Mixer/Injectors*	Testing of the component as per ECE Regulation No. 67 by test agency. Alternatively, test agency to verify the test certificate or report conforming to the above standard issued by accredited testing laboratory.	ECE Regulation No. 67
5	Petrol and Gas Solenoid Valve*	Testing of the component as per ECE Regulation No. 67 by test agency. Alternatively, test agency to verify the test certificate or report conforming to the above standard issued by accredited testing laboratory.	ECE Regulation No. 67 Note: Petrol solenoid valve is to be tested, as per ECE Regulation No. 67, for endurance only at a pressure 1.5 times the working pressure for 6,000 no. of cycles.
6	Inspection, Testing & Commissioning Certificate Leak testing Excess flow valve test* Automatic fill limiter* Compartment / sub compartment	To be as per Safety Code of Practice	
7	Filling Connection (if Applicable)	Installation to be checked as per Safety Code of Practice	Clauses 5.3.2 to 5.3.6 of Safety Code of Practice
8	Ventilation (if Applicable)	to be checked as per Safety Code of Practice	5.7.2 of Safety Code of Practice

Sr. No.	LPG Kit Component	Certifying /Verifying Authority	Clause of Safety code of practice / Other Standards, Rules, etc.
9	Testing of Conduit* (if Applicable)	To be tested as per AIS 026	AIS 026
10	LPG fuel line	Shall be tested as per IS:6044 (Part 1)	
a)	Fuel line	Shall be tested as per IS:6044 (Part 1)	
	Pressure testing	Testing/Verification of Certificate with Test Report by Test Agency as per equivalent standard.	
	Size of tube as per Engine capacity	Manufacturer's declaration to be verified by Test Agency	
	On site Fitment on Genset	Installer shall meet the installation requirements as per IS: 6044 (Part 1) and this standard	
b)	Flexible Hose / fuel line	Shall be tested as per IS: 6044 (Part 1)	
	Material	Testing/Verification of Certificate with Test Report by Test Agency as per IS :6044 or equivalent standard.	
c)	Fitment on Genset	Installer shall meet the installation requirements as per IS: 6044 (Part 1) and this standard.	
	Pressure	Shall be tested as per IS: 6044 (Part 1)	
d)	Joints and connections to Withstand Pressure without any leakage	Installer shall meet the installation requirements as per IS: 6044(Part 1) and this standard	
11	Compartment or Sub compartment* (if Applicable)	Test to be carried out by test agency as per Safety Code of Practice	Relevant clauses of Safety code of Practice
12	Safety check for installation of LPG system	Safety checks to be carried out by test agency as per Safety Code of Practice	Relevant clauses of Safety code of Practice

* Certificate issued by accredited testing agency of the country of origin or a report issued by internationally accredited test laboratory may also be accepted.

Note 1 - Even though all above standards are applicable for automotive applications, considering the use of same or equivalent fuel for Generator application these standards shall be used for LPG components certifications of Generator.

Note 2 - Only the standards, as amended from time to time, as mentioned above, shall be referred for compliance.

Note 3 - Approvals issued prior to implementation of these rules shall be extended for compliance to above requirements without revalidation.

ANNEXURE - 7

Roles & responsibility of various stakeholders

Sr No	Activity	Responsibility	Remark
1	Getting the approval of NG/LPG/CNG Kit components, approval of cylinders and valves,	Genset / Engine manufacturer as the case may be.	
2	Getting the Type approval of engines / Gensets for emission and noise compliance.	Genset / Engine manufacturer as the case may be.	
3	Getting the approval of PNG lines, joints and connections for NG Gensets.	Genset manufacturers / its authorized person or agency.	
4	Approval of NG/LPG/CNG Kit components	Test agencies approved by MoEF / CPCB	
5	Approval of Cylinders and valves	PESO, Govt of India	
6	Type approval of engines / Gensets for emission and noise compliance	Test agencies approved by MoEF/ CPCB	
7	Installation of Genset with CNG/NG/LPG system at site as per type approved specifications. Installation of LPG cylinders and its manifolding system at site as per IS 6044 (Part 1) as amended from time to time.	Genset manufacturer / its authorized person or agency	
8	Issue of Installation Certificate	Genset manufacturer / its authorized person or agency	
9	Re-testing of CNG/LPG cylinders as per Gas Cylinder Rules after installation	End User	
10	Training to end user about safety and operation of Genset using gaseous fuels in any combination – dedicated / bi-fuel / dual-fuel	Genset manufacturer/ its authorized person or agency	
11	Scrapping of CNG/LPG cylinders as per Gas cylinder rules	End User	
12	Periodic leak testing and inspection of gaseous fuel system as per training imparted by Authorized person / Genset manufacturer	End use	
13	Approval of PNG lines and its joints and connections	City Gas Distribution companies approved by PNGRB, Govt of India	
14	System Procedure and Safety Procedure documents	CPCB (Nodal agency)	

ANNEXURE - 8

Labelling requirements

The engine or the product must be affixed with a conformance label meeting the following requirements.



8.1 General Requirement

- a. The label shall be durable and legible;
- b. The label shall be affixed on a part necessary for normal operation of the engine or the product and not normally requiring replacement during the life of the engine or the product;
- c. Statement that 'this engine or product conforms to the Environment Protection Rule 1986;
- d. All the information mentioned in the conformance label must be in English language;

8.2 Conformance Labelling Content Requirement

- a. Name the engine manufacturer or the engine or product importer
- b. Manufacturing plant address from where engine is manufacture
- c. Engine Model name;
- d. Rated speed and corresponding gross power in kW;
- e. Engine Unique Identification Number (Serial Number, etc.);
- f. Date of manufacturing and in case of import, date of import of engine or Genset product;
- g. Type Approval certificate number;
- h. Letter 'G' to denote that the engine is belongs to Genset application. The Letter 'G' shall be engraved on the conformance label. The letter(s) should have a minimum size of 7 mm.

Compliance name plate model

Manufacturer	<input type="text"/>	 <small>COMPANY LOGO</small>	
Mfg. Plant	<input type="text"/>		
Engine Model	<input type="text"/>	Rated Speed (rpm)	<input type="text"/>
		Power (kW)	<input type="text"/>
Engine Sr No	<input type="text"/>	Date of Mfg.	<input type="text"/>
Type Approval Cert. No.	<input type="text"/>		
This engine or product conforms to the Environment Protection Rule 1986			

APPENDIX 8.1

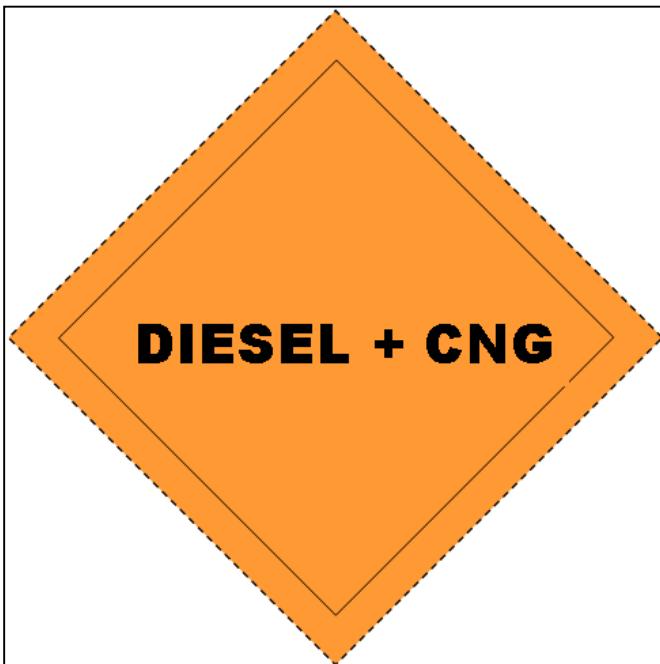
LABEL	
	
The sign consists of a sticker which shall be weather resistant.	
The color and dimensions of the sticker shall fulfil the following requirements:	
Colors:	
Background:	Orange
Letters:	Black or black reflecting
Dimensions:	
Border width:	4 - 6 mm
Character height:	≥ 25 mm

Character thickness:	≥ 4 mm
Sticker width:	110 - 150 mm
Sticker height:	80 - 110 mm
The word "DIESEL+CNG" shall be centered in the middle of the sticker.	

∞∞ End of The Document ∞∞